

# **Coolmay L02 Series PLC Programming Manual**

(PLC part: Difference comparing with FX3G)

Copyright: Shenzhen Coolmay Technology Co., Ltd.

V22.81

# Catalog

1. Overview .....	1
1.1. Coolmay L02 PLC has the following advantages: .....	1
1.2. Coolmay L02 System Architecture .....	4
1.3. Host operation .....	5
1.4. L02 series host and modules description .....	7
1.5. L02 series host and module power reference table .....	8
1.6. Precautions for L02 series host programming .....	9
2. Device Number .....	11
2.1. Device number table .....	11
3. Special relay and register .....	13
3.1. Special relay number and content .....	13
3.2. Special register number and content .....	17
4. Function Instructions .....	20
4.1. List of basic logic instructions .....	20
4.2. Applied instructions 【Sequence is according to instruct variety】 .....	21
5. Application of analog .....	28
5.1. Analog input .....	28
5.1.1. L02M24 Host analog input type .....	28
5.1.2. L02M24 Host analog input read .....	28
5.1.3. Expansion analog module input type .....	29
5.1.4. Expansion analog module input read .....	29
5.1.5. Host Analog input sampling .....	31
5.1.6. Analog input program example .....	31
5.2. Analog output .....	33
5.2.1. L02M24 Host analog output setting .....	33
5.2.2. Expand analog module output setting .....	33
5.2.3. Host analog output program example .....	34
5.3. PID Instruction .....	34

5.3.1. Outline .....	34
5.3.2. PID instruction format and parameter description .....	34
5.3.3. Function and action description .....	35
5.3.4. Notice .....	37
5.3.5. Example .....	37
6. Application of high speed counter .....	39
6.1. Assignment table of built-in high speed counter .....	39
6.2. Related device .....	40
7. Application of high speed pulse .....	41
7.1. high speed pulse output .....	41
7.2. Circular interpolation .....	42
7.2.1. Normal interpolation function .....	42
7.2.2. Continuous interpolation function .....	44
7.3. Pulse width modulation PWM .....	47
7.4. Handwheel pulse function .....	50
8. Coolmay L02 series PLC communication manual .....	53
8.1. MODBUS instruction explanation and communication address .....	53
8.1.1. Function and operation description of read/write data command .....	53
8.1.2. ADPRW instruction function and operation description .....	54
8.1.3. Word device communication address number .....	56
8.1.4. Bit device communication address number .....	56
8.1.5. ADPRW instruction function parameters .....	57
8.2. Serial port 1: RS232 (PLC programming port) .....	57
8.3. Serial port 2: RS485 (A B)/RS232 .....	57
8.3.1. Mitsubishi programming port .....	59
8.3.2. Mitsubishi BD Protocol .....	60
8.3.3. Freeport protocol functions and examples .....	61
8.3.4. Modbus RTU protocol .....	62
8.3.5. Modbus RTU function ADPRW instruction .....	65
8.3.6. Modbus ASCII protocol .....	67
8.4. Serial port 3: RS485 (A1 B1) .....	68
8.4.1. Mitsubishi programming port protocol .....	71

8.4.2. Freeport protocol function .....	71
8.4.3. Modbus RTU function RD3A/WR3A instruction .....	72
8.4.4. Modbus RTU Function ADPRW instruction .....	75
8.4.5. Modbus ASCII function .....	76
8.5. CAN Communication port .....	77
8.5.1. Freeport protocol function .....	80
8.5.2. Modbus RTU function RD3A/WR3A instruction .....	81
8.5.3. Modbus RTU function ADPRW instruction .....	83
8.6. Network communication .....	84
8.6.1. MITSUBISHI MC protocol .....	87
8.6.2. Modbus TCP Function .....	92
8.6.3. Ethernet/IP function .....	94
8.7. Network N:N communication .....	104
8.7.1. Related device content .....	104
8.7.2. Program settings and instructions .....	106
9. Coolmay L02 series PLC hardware identification and address allocation .....	108
9.1. Hardware identification of digital input and output modules .....	108
9.2. Address allocation of digital input and output modules .....	109
9.3. Hardware identification of analog input and output modules .....	110
9.4. Address reading of analog input and output modules .....	111
Appendix Version Change Record .....	112

## 1. Overview

### 1.1. Coolmay L02 PLC has the following advantages:

L02 series CPU module is a high-end application controller. L02 series CPU has built-in up to 8 axis (pulse type) positioning outputs, up to 6 groups of high-speed counter inputs, and diverse network communication options, providing users with powerful network functions. By setting program to establish various network device links. With the built-in memory card function of the L02 series CPU module, system settings can be quickly backed up or restored.

This manual describes the basic operating functions of the L02 system, allowing users to quickly get started with the L02 system.

#### 1) Function Feature:

◆ Adopting Military level 32 bit CPU, compatible to with Mitsubishi FX3G/FX3U/FX3S series PLC, run faster and more adapted to industrial environment of high electromagnetic interference.

◆ The high-speed pulse output of the host L02M32T/L02M24T is generally 8 channels. Each channel of Y0~Y3 can reach 100KHz, and each channel of Y4~Y7 can reach 50KHz.

◆ High-speed counting is generally single-phase 6-channel 60KHz or AB (Z) phase 2-channel 30KHz + AB-phase 1-channel 5KHz.

◆ Special encryption, prevent illegal reading thoroughly. 8-bit encryption, 12345678 as password can thoroughly prevent reading of ladder logic program.

#### 2) Supporting more I/O

◆ L02 series plc can support at most 512 i/o or 31 pieces modules (regardless of type) or 12 analog i/o modules.

The extended I/O address does not require programming, is automatically assigned, and the module is easy to use by plugging and playing.

◆ Digital input and output expansion, the expansion address starts from X20, Y20.

◆ L02 series can be matched with L02-EIP module to establish remote I/O communication.

Remarks: 256 points (X0~X177, Y0~Y177) in FX3G mode.

512 points (X0~X377, Y0~Y377) in FX3U mode.

### 3) Diversified I/O module option

◆ L02 series CPU modules support the following types of I/O modules: digital I/O modules, analog I/O modules, temperature and weighing modules, and Ethernet/IP modules.

Module Type	I/O	Model
Digital I/O modules	Input	L02-8EX,L02-16EX,L02-32EX
	Output	L02-8EYT,L02-8EYR,L02-16EYT,L02-16EYR,L02-16EYP,L02-32EYT
	Mixed Input/Output	L02-16ET,L02-16ER,L02-32ET
Analog I/O modules	Input	L02-4AD
	Output	L02-4DA
	Mixed Input/Output	L02-4AD2DA
Temperature and Weighing modules		L02-4RTD,L02-4TC,L02-4NTC,L02-2TC
Ethernet/IP modules		L02-EIP

### 4) Larger program capacity and data memory block

◆ L02 series CPU module, the program capacity can reach 32k steps. Built-in 8K registers (128 points for usual, 7872 points for power failure retention), and 24k file registers (support power failure retention).

### 5) Support Mitsubishi programming software

◆ L02 series CPU module, the programming software is compatible with GX Developer8.86/GX Works2.

- ◆ Support online editing mode, allowing users to update the program without affecting the system operation while the system is running.

- ◆ Supported programming languages: Ladder Diagram (LD) and Sequential Function Chart (SFC).

**Note: Structured programming and tags are not supported.**

#### 6) Multifunctional communication interface

- ◆ L02 series host PLC has two default programming ports, 1 Type-C programming port, the download speed is faster; 1 RS232, which the interface terminal is an 8-hole mouse head female socket.

**Note: When using FX3U mode, the download program only supports RS232 download.**

- ◆ Provide 2 RS485, support Mitsubishi programming port protocol/modbus RTU protocol/free port protocol/Mitsubishi BD board protocol, easily realize PLC interconnection and communication with external equipment such as HMI and vfd inverters .

- ◆ 1 CAN, support CAN2.0A, CAN2.0B, modbus networking and free port protocol, can easily realize multi-channel interconnection.

- ◆ 1 high-speed Ethernet interface, supporting Mitsubishi programming port protocol, modbus TCP/UDP protocol, Ethernet/IP protocol.

#### 7) Memory card storage interface

- ◆ The memory card interface provides the following functions:

System backup: user programs, CPU parameters, I/O configuration settings, device settings

System response: user program, CPU parameters, I/O configuration settings, device settings

Parameter storage: device content value

Record storage: system error record, system status record

#### 8) Installation and I/O module replacement method

- ◆ The host PLC supports perpetual calendar timing function, using CR1620 battery, drawer type which can be installed by itself.

- ◆ Easy to install. It can be installed on DIN rail (35mm width).

- ◆ When the power is off, all L02 series modules support buckle installation and replacement modules.

- ◆ Flexible use, more specifications and batches can be customized according to customer requirements.

## 1.2. Coolmay L02 System Architecture

L02 series PLC is Coolmay small and medium-sized programmable control system. In addition to the improvement of execution speed and storage capacity, it also provides a more flexible system expansion architecture in order to meet users' higher-end application requirements. Under such a system architecture, users will not have to split the system into multiple host systems for control due to excessive system points or excessive distance between devices. In this way, the integrity of the system can be preserved, and Allow users to be more efficient in the project development process.

Minimum architecture requirements for L02 series:

To build an L02 system, at least one host module and one power supply module must be included so that the system can be planned and operated.

**Power Supply Module+L02 Host (L02-60P+L02M32T) ; The power module can also directly use an external DC24V switching power supply.**

Maximum architecture requirements for L02 series:

To build an L02 system, its maximum limit is the following three limit conditions. If any one of the limit conditions is exceeded, the host will send out an alarm message.

**Limit 1: The number of expansion modules is up to 31. (Excluding power supply, host and remote module)**

**Limit 2: The maximum total number of digital points is 512 points. (Including built-in points of the host)**

**Limit 3: No more than 12 analog input/output module respectively. (That is 50 points, excluding the host AI/O points)**

### 1.3. Host operation

The host is the core component of the entire L02 series. In addition to executing the user's logic program, it is also responsible for all I/O data receiving and sending, and data communication processing. The relationship between the L02 system established by the host and related modules and the actual external devices can be simply expressed as follows:

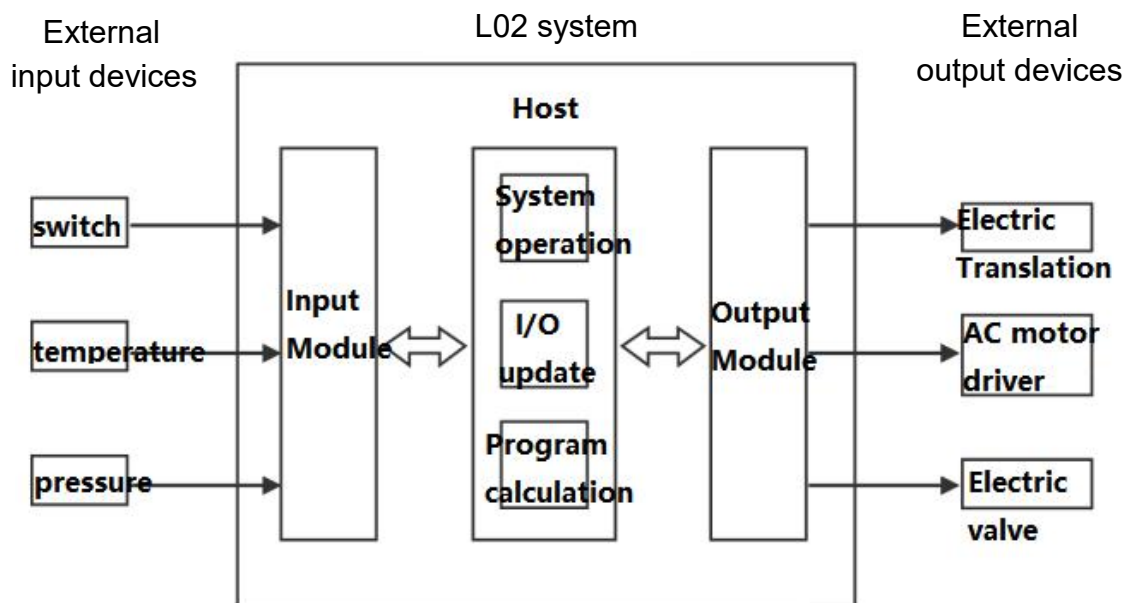

Above is a simple expression of the operation of the host, which simplifies the process of initialization, diagnosis, communication and other system aspects, and the process of external interruption, time interruption and other

program aspects. If you are interested in a deeper understanding, please refer to the complete description.

The content of the manual, the complete host operation process is listed below for reference.

On power



System startup initialization:

- Non-power failure retention memory initialization
- User program inspection
- CPU module parameter check
- I/O table parameter check
- Comparison between CPU memory I/O table and actual device I/O
- Download I/O settings to I/O modules
- If you install a memory card, check whether the system copy option is set to perform system copy



Diagnostic treatment:

- Check Memory card and other settings
- Check Module communication
- Check System parameter



I/O input data update:

- Update digital I/O module input data
- Update analog I/O module input data
- Update other module input data



Program execution:

- Execute user program
- Execute interrupt program



I/O output data update:

- Update digital I/O module output data
- Update analog I/O module output data
- Update other module output data



Communication service:

- External communication processing of host communication port
- External communication processing of other I/O modules
- Internal communication processing between host and I/O module

#### 1.4. L02 series host and modules description

Sort	Model	Description
PSU Module	L02-60P	Input: 100-240VAC, 50/60Hz AC power input. Output (for L02 series internal use): 24VDC/1.5A, 36W Output (for external use): 24VDC/0.5A, 12W
L02 CPU Module	L02M32T	CPU module, transistor (NPN) output, built-in Ethernet, RS-485*2, RS232, Type-C download port, Micro SD card interface, CAN communication port and 32-point IO (16DI+16DO), support up to 512-point I/O, program capacity 32k steps, using push-type terminals
	L02M32R	CPU module, relay output, built-in Ethernet, RS-485*2, RS232, Type-C download port, Micro SD card interface, CAN communication port and 32-point IO (16DI+16DO), support up to 512-point I/O, program Capacity 32k steps, using push-type terminals
	L02M24T	CPU module, transistor (NPN) output, built-in Ethernet, RS-485*2, RS232, Type-C download port, Micro SD card interface, CAN communication port; 24 points IO (12DI+12DO) and 8 points AI (4AD+ 4DA), support up to 512 points I/O, program capacity 32k steps, using push-type terminals
	L02M24R	CPU module, relay output, built-in Ethernet, RS-485*2, RS232, Type-C download port, Micro SD card interface, CAN communication port; 24 points IO (12DI+12DO) and 8 points AI (4AD+4DA), support up to 512 points I/O, program capacity 32k steps, using push-type terminals
Digital input Module	L02-8EX	DC24V, 6mA, 8 points input, push-type terminal
	L02-16EX	DC24V, 6mA, 16 points input, push-type terminal
	L02-32EX	DC24V, 6mA, 32 points input, horn block terminal
Digital output Module	L02-8EYT	30VDC, 2A/point; 2A/4point COM, 8 points transistor output, push-type terminal
	L02-8EYR	Below AC220V / Below DC30V, 2A/point, 4A/4point COM, 8 points relay output, push-type terminal
	L02-16EYT	30VDC, 2A/point; 2A/4point COM, 16 points transistor output, push-type terminal
	L02-16EYP	30VDC, 2A/point; 2A/4point COM. 16 output points, MOS tube PNP output, push-type terminal block
	L02-16EYR	Below AC220V / Below DC30V, 2A/point, 4A/4point COM, 16 points relay output, push-type terminal
	L02-32EYT	30VDC, 2A/point; 2A/4point COM, 32 points transistor output, horn block terminal
Digital input Output mixed	L02-16ET	DC24V, 6mA, 8 points input; 30VDC, 2A/point; 2A/4point COM, 8 points transistor

Sort	Model	Description
Module		output, push-type terminal
	L02-16ER	DC24V, 6mA, 8 points input; Below AC220V / Below DC30V, 2A/point, 4A/4point COM, 8 points relay output, push-type terminal
	L02-32ET	DC24V, 6mA, 16 points input; 30VDC, 2A/point; 2A/4point COM, 16 points transistor output, horn block terminal
Analog input Module	L02-4AD	channel analog signal input 16-bit resolution 0~10V, 0~5V, 0~20mA, -20~20mA
Analog output Module	L02-4DA	4-channel analog signal output 16-bit resolution 0~5V, 0~10V, 0~20mA
Analog input Output mixed Module	L02- 4AD2DA	4-channel analog signal input 16-bit resolution 0~10V, 0~5V, 4~20mA, 0~20mA 2-channel analog signal output 16-bit resolution 0~5V, 0~10V, 0~20mA
Temperature Module	L02-4RTD	4-channel 2-wire or 3-wire RTD temperature sensing Sensor type: Pt100 Resolution: 0.1°C/0.1°F(16 bit converter)
	L02-4TC	4-channel thermocouple temperature sensing Sensor type: J, K, S, T, E Resolution: 0.1°C/0.1°F (16 bit converter)
	L02-4NTC	4-channel thermistor temperature sensing Sensor type: NTC10K/50K/100K Resolution: 0.1°C/0.1°F (16 bit converter)
Weighing/Loa d cell Module	L02-2LC	2-channel 4-wire load cell Characteristic values: 1, 2, 4, 6, 20, 40, 80 mV/V Accuracy error value: one ten thousandth (1/10000) ADC resolution: 24 bits
Ethernet/IP Module	L02-EIP	Built-in two Ethernet interfaces, support switch function Support Ethernet/IP protocol, remotely expand I/O available.

### 1.5. L02 series host and module power reference table

Product model	Voltage (V)	Current (mA)	Maximum power loss (W)
L02M32R	DC24	250	4
L02M32T	DC24	120	2
L02M24R	DC24	230	4
L02M24T	DC24	110	2
L02-8EX	DC24	25	0.75
L02-16EX	DC24	28	1.5
L02-32EX	DC24	30	0.4
L02-16ET	DC24	60	0.95

L02-32ET	DC24	90	1.55
L02-16ER	DC24	95	1.6
L02-8EYR	DC24	120	2.1
L02-8EYT	DC24	45	0.75
L02-16EYR	DC24	135	2.25
L02-16EYT	DC24	65	1.08
L02-16EYP	DC24	73	1.75
L02-32EYT	DC24	90	1.5
L02-4AD	DC24	30	0.5
L02-4DA	DC24	85	1.4
L02-4AD2DA	DC24	110	1.95
L02-4RTD	DC24	30	0.5
L02-4TC	DC24	30	0.5
L02-4NTC	DC24	35	0.5
L02-2LC	DC24	65	1.08
L02-EIP	DC24	150	2.1
L02-60P	AC220	40	7

## 1.6. Precautions for L02 series host programming

The PLC is compatible with GX Developer8.86Q/GX Works2 and the following version programming software. Use other versions of the software, there may be incompatibilities.

A prompt error occurred during PLC program download: the com port cannot be specified. GX Developer 8.86 software: online-change the com port in the transfer setting; GX Works2: all targets-change the com port in all connected targets. If there is a communication abnormality or cable abnormality, it can be eliminated by cutting off the power, checking the cable, checking whether the power supply is normal, or changing the computer.

Select in the GX Developer 8.86 version as shown in the figure:

New Project

PLC series: FXCPU

PLC Type: FX3G

Program type:  Ladder,  SFC,  ST,  MELSA-P-L

Label setting:  Do not use lab,  Use label (Select when using ST, FB and structures)

Device memory data which is the same as program data's name

Setup project name:  Setup project name

Drive/Path: E:\MELSEC\GPPW

Project: [ ] Browse...

Title: [ ]

OK, Cancel

Select in the GX Works2 software version as shown in the figure: (Note: the use of labels is prohibited)

New Project

Project Type: Simple Project

Use Label

PLC Series: FXCPU

PLC Type: FX3G/FX3GC

Language: Ladder

OK, Cancel

## 2. Device Number

### 2.1. Device number table

Name	Contents		
I/O relay			
Input relay	X000~X377	256 points	It is octal number Total 512 I/O
Output relay	Y000~Y377	256 points	
Auxiliary relay			
General	M0~M383	384 points	
EEPROM hold	M384~M1535	1152 points	
General	M1536~M7679	6144 points	
Special	M8000~M8511	512 points	
Status			
Initial state (EEPROM hold)	S0~S9	10 points	
EEPROM hold	S10~S999	990 points	
General	S1000~S4095	3096 points	
Timer (ON delay timer)			
100ms	T0~T199	200 points	0.1~3,276.7s
10ms※1	T200~T245	46 points	0.01~327.67s
1ms accumulative (EEPROM hold)	T246~T249	4 points	0.001~32.767s
100ms accumulative (EEPROM hold)	T250~T255	6 points	0.1~3,276.7s
1ms	T256~T319	64 points	0.001~32.767s
Counter			
General up counter (16bit)	C0~C15	16 points	0~32,767 counter
EEPROM hold up counter (16 bit)	C16~C199	184 points	0~32,767 counter
General bi-direction (32 bit)	C200~C219	20 points	-2,147,483,648~ +2,147,483,647 counter
EEPROM hold bi-direction (32 bit)	C220~C234	15 points	-2,147,483,648~ +2,147,483,647 counter
High-speed counter			
Single-phase single counter input Bi-direction (32 bit) (EEPROM hold)	C235~C245	-2,147,483,648~+2,147,483,647 Counter Software counter Single phase: at most 6 channel, 60kHz Double phase: 1 times frequency:at most 2-3 channels, Max frequency 30KHz; M8198 is 4 times frequency sign of C251/C252. 4 times frequency:at most 2 channels, 24kHz,M8199 is 4 times frequency sign of C253/C255.	
Single-phase double counter input Bi-direction (32 bit) (EEPROM hold)	C246~C250		
Double -phase double counter input Bi-direction (32 bit)(EEPROM hold)	C251~C255		

Name	Contents		
Data register(32 bit when using in pair)			
General(16bit)	D0~D127	128 points	
EEPROM hold (16 bit)	D128~D7999	7872 points	
Special (16 bit)	D8000~D8511	512 points	
Index (16 bit)	V0~V7,Z0~Z7	16 points	
Extended register·extended file register			
Extended register(16 bit)	R0~R22999	23000points Support power failure retention	
	R23000~R23999	1000points for system internal	
Pointer			
JUMP,CALL branch	P0~P1280	1281 points	CJ instruction, CALL instruction
Input interrupt	I0□□~I5□□	6 points	
Timer interrupt	I6□□~I8□□	3 points	
Counter interrupt	I010~I060	6 points	
Nest			
Main control	N0~N7	8points	MC instruct
Constant			
Decimal (K)	16 bit	-32,768~+32,767	
	32 bit	-2,147,483,648~+2,147,483,647	
Hexadecimal (H)	16 bit	0000~FFFF	
	32 bit	00000000~FFFFFFFF	
Real number(E)	32 bit	-1.0×2 <sup>128</sup> ~-1.0×2 <sup>-126</sup> ,1.0×2 <sup>-126</sup> ~1.0×2 <sup>128</sup> Can be in the form of a decimal point and index	

※1: The 10ms timer will be affected by the scan cycle. If the scan period is 12ms, the timer becomes 12ms and is executed once.

### 3. Special relay and register

#### 3.1. Special relay number and content

Num	Content	Remarks	Num	Content	Remarks	
M8000	In RUN, Normally closed		M8224	C224 Increase/decrease counting action	ON:decrease action OFF:increase action	
M8001	In RUN, Normally open		M8225	C225 Increase/decrease counting action		
M8002	After RUN, Output a scan cycle ON		M8226	C226 Increase/decrease counting action		
M8003	After RUN, Output a scan cycle OFF		M8227	C227 Increase/decrease counting action		
M8011	Oscillating in 10ms cycle		M8228	Handwheel function enablement		
M8012	Oscillating in 100ms cycle		M8229	C229 Increase/decrease counting action		
M8013	Oscillating in 1s cycle		M8230	C230 Increase/decrease counting action		
M8014	Oscillating in 1min cycle		M8231	C231 Increase/decrease counting action		
M8020	Zero flag		M8232	C232 Increase/decrease counting action		
M8021	Borrowing flag		M8233	C233 Increase/decrease counting action		
M8022	Carry flag		M8234	C234 Increase/decrease counting action		
M8024	Specify BMOV direction		M8235	C235 Increase/decrease counting action		ON:decrease action OFF:increase action
M8028	During instruction execution, allow interrupt		M8236	C236 Increase/decrease counting action		
M8029	Instruction execution end flag		M8237	C237 Increase/decrease counting action		
M8031	Non-retentive memory is cleared		M8238	C238 Increase/decrease counting action		
M8032	Retentive memory is cleared		M8239	C239 Increase/decrease counting action		
M8033	Memory retention stop		M8240	C240 Increase/decrease counting action		
M8034	Prohibit all output		M8241	C241 Increase/decrease counting action		
M8035	Forced RUN mode		M8242	C242 Increase/decrease counting action		
M8036	Force RUN command		M8243	C243 Increase/decrease counting action		
M8037	Force STOP command		M8244	C244 Increase/decrease counting action		
M8045	Prohibit reset of all outputs		M8245	C245 Increase/decrease counting action		
M8046	STL state action		M8246	C246 Increase/decrease counting action	ON:decrease	

Num	Content	Remarks	Num	Content	Remarks
				action	action
M8047	STL temporary control is effective		M8247	C247 Increase/decrease counting action	OFF:increase action
M8048	Signal alarm action		M8248	C248 Increase/decrease counting action	
M8049	Signal alarm is effective		M8249	C249 Increase/decrease counting action	
M8050	Input interrupt (I00 is prohibited)		M8250	C250 Increase/decrease counting action	
M8051	Input interrupt (I10 is prohibited)		M8251	C251 Increase/decrease counting action	
M8052	Input interrupt (I20 is prohibited)		M8252	C252 Increase/decrease counting action	
M8053	Input interrupt (I30 is prohibited)		M8253	C253 Increase/decrease counting action	
M8054	Input interrupt (I40 is prohibited)		M8254	C254 Increase/decrease counting action	
M8055	Input interrupt (I50 is prohibited)		M8255	C255 Increase/decrease counting action	
M8056	Timer interrupt (I6 is prohibited)		M8340	1st pulse operation temporary control	
M8057	Timer interrupt (I7 is prohibited)		M8341	Y000 clear signal output function is valid	
M8058	Timer interrupt (I8 is prohibited)		M8342	Y000 specify the origin return direction	
M8059	Counter interrupt is prohibited		M8343	Y000 forward limit	
M8060	I/O Constitute error		M8344	Y000 reverse limit	
M8061	PLC hardware error		M8345	Y000 near-point DOG signal logic inversion	
M8062	Serial communication error 0		M8346	Y000 zero signal logic inversion	
M8063	Serial communication error 1		M8347	Y000 interrupt signal logic inversion	
M8064	Parameter error		M8348	Y000 positioning command driver	
M8065	Grammatical error		M8349	1st pulse stop	
M8066	Loop error		M8350	2nd pulse operation temporary control	
M8067	Operation error		M8351	Y001 clear signal output function is valid	
M8068	Operation error latch		M8352	Y001 specify the origin return direction	
M8069	I/O bus detection		M8353	Y001 forward limit	
M8075	Sample tracking preparation start command		M8354	Y001 reverse limit	
M8076	Sample tracking execution start command		M8355	Y001 near-point DOG signal logic inversion	
M8077	Sampling and tracking execution temporary control		M8356	Y001 zero signal logic inversion	
M8078	Sample tracking execution end		M8357	Y001 interrupt signal logic	

Num	Content	Remarks	Num	Content	Remarks
	temporary control			inversion	
M8079	Sampling tracking system area		M8358	Y001 positioning command driver	
M8120	Can't use		M8359	2nd pulse stop	
M8121	RS/RS2 command sends standby	Serial Port 2 refer to chapter 8.2	M8360	3rd pulse operation temporary control	
M8122	RS/RS2 command to send request		M8361	Y002 clear signal output function is valid	
M8123	RS/RS2 command reception end		M8362	Y002 specify the origin return direction	
M8124	RS/RS2 command data in reception		M8363	Y002 forward limit	
M8125	MODBUS and Mitsubishi function enablement		M8364	Y002 reverse limit	
M8128	RD3A/WR3A Receive correct		M8365	Y002 near-point DOG signal logic inversion	
M8129	RD3A/WR3A communication timeout		M8366	Y002 zero signal logic inversion	
M8151	5th pulse operation temporary control		M8367	Y002 interrupt signal logic inversion	
M8152	6th pulse operation temporary control		M8368	Y002 positioning command driver	
M8153	7th pulse operation temporary control		M8369	3rd pulse stop	
M8154	8th pulse operation temporary control		M8370	4th pulse operation temporary control	
M8160	XCH's SWAP function		M8371	Y003 clear signal output function is valid	
M8161	8-bit processing mode		M8372	Y003 specify the origin return direction	
M8170	Input X000 pulse capture		M8373	Y003 forward limit	
M8171	Input X001 pulse capture		M8374	Y003 forward limit	
M8172	Input X002 pulse capture		M8375	Y003 near-point DOG signal logic inversion	
M8173	Input X003 pulse capture		M8376	Y003 zero signal logic inversion	
M8174	Input X004 pulse capture		M8377	Y003 interrupt signal logic inversion	
M8175	Input X005 pulse capture		M8378	Y003 positioning command driver	
M8176	Input X006 pulse capture		M8379	4th pulse stop	
M8177	Input X007 pulse capture		M8396	C254 function corresponds to input phase	
M8192	Programming port protocol and other protocol enablement	Serial port3	M8401	RS2 command sends standby	
M8196	Programming port protocol and other protocol enablement	Serial port2	M8402	RS2 command to send request	
M8198	4 times frequency of C251/C252		M8403	RS2 command reception end	
M8199	4 times frequency of C253/C255		M8404	RS2 command data in reception	Refer to chapter 6.1

Num	Content	Remarks	Num	Content	Remarks
M8200	C200 Increase/decrease counting action	ON:decrease action OFF:increase action	M8405	RS2 command data setting ready	Serial port 3 Refer to chapter 8.3
M8201	C201 Increase/decrease counting action		M8408	RD3A/WR3A Receive Completed	
M8202	C202 Increase/decrease counting action		M8409	RD3A/WR3A communication timeout	
M8203	C203 Increase/decrease counting action		M8421	RS2 command sends standby	
M8204	C204 Increase/decrease counting action		M8422	RS2 command to send request	
M8205	C205 Increase/decrease counting action		M8423	RS2 command reception end	
M8206	C206 Increase/decrease counting action		M8424	RS2 command data in reception	
M8207	C207 Increase/decrease counting action		M8425	RS2 command data send completed	CAN communication Refer to chapter 8.5
M8208	C208 Increase/decrease counting action		M8426	RS command master-slave and multi-machine mode	
M8209	C209 Increase/decrease counting action		M8427	CAN data standard frame and extended frame	
M8210	C210 Increase/decrease counting action		M8428	CAN communication MODBUS response correct	
M8211	C211 Increase/decrease counting action		M8429	Communication timeout	
M8212	C212 Increase/decrease counting action		M8432	Interpolation mode	
M8213	C213 Increase/decrease counting action		M8433	Interpolation mode	
M8214	C214 Increase/decrease counting action		M8434	Interpolation relative/absolute coordinate	
M8215	C215 Increase/decrease counting action		M8435	Interpolation counterclockwise	
M8216	C216 Increase/decrease counting action		M8450	5th pulse stop	
M8217	C217 Increase/decrease counting action		M8451	6th pulse stop	
M8218	C218 Increase/decrease counting action		M8452	7th pulse stop	
M8219	C219 Increase/decrease counting action		M8453	8th pulse stop	
M8220	C220 Increase/decrease counting action				
M8221	C221 Increase/decrease counting action				
M8222	C222 Increase/decrease counting action				
M8223	C223 Increase/decrease counting action				

### 3.2. Special register number and content

Num	Content	Remarks	Num	Content	Remarks
D8000	Watchdog timer		D8186	Z3 Register contents	
D8001	PLC type and system version	Main version number	D8187	V3 Register contents	
D8002	PLC memory capacity	2...2K steps; 4...4K steps; 8...8K steps; When 16K steps and above, D8002=8,D8102 is corresponded to 16,32,64	D8188	Z4 Register contents	
D8003	Memory type	10H:Programmable controller built-in memory	D8189	V4 Register contents	
D8010	Scan current value		D8190	Z5 Register contents	
D8011	Scan time minimum		D8191	V5 Register contents	
D8012	Scan time maximum		D8192	Z6 Register contents	
D8013	Second		D8193	V6 Register contents	
D8014	Minute		D8194	Z7 Register contents	
D8015	Hour		D8195	V7 Register contents	
D8016	Date		D8268	Customize the frequency of PWM0~3	Value range:840~16800000
D8017	Month		D8269		
D8018	Year		D8278	Customize the frequency of PWM4~7	
D8019	Week		D8279		
D8020	Input filter adjustment		D8340	1st position pulse amount	Low
D8030	AD0 analog input value		D8341		High
D8031	AD1 analog input value		D8342	Y0 deviation speed Initial value:0	
D8032	AD2 analog input value		D8343	1st pulse maximum speed	Low
D8033	AD3 analog input value		D8344		High
D8050	DA0 analog output value		D8345	Y0 crawling speed Initial value: 1000	
D8051	DA1 analog output value		D8346	Y0 Origin return speed Initial value:50000	Low
D8052	DA2 analog output value		D8347		High
D8053	DA3 analog output value		D8348	1st pulse acceleration time	
D8054	Module digital input bytes		D8349	1st pulse deceleration time	
D8055	Module analog input words		D8350	2nd position pulse amount	Low
D8056	Module digital output bytes		D8351		High
D8057	Module analog output words		D8352	Y1 deviation speed Initial value:0	
D8058	When DA is current, Bit setting	Refer to chapter 5.2	D8353	2nd pulse maximum speed	Low
D8059	Constant scan time		D8354	Y1 crawling speed Initial value: 1000	High
D8074	X0 Rising edge ring counter value	Low	D8355		
D8075	[1/6μs unit]	High	D8356	Y1 Origin return speed	Low

Num	Content	Remarks	Num	Content	Remarks
D8076	X0 falling edge ring counter value	Low	D8357	Initial value:50000	High
D8077	[1/6μs unit]	High	D8358	2nd pulse acceleration time	
D8078	X0 pulse width / pulse period	Low	D8359	2nd pulse deceleration time	
D8079	[10μs unit]	High	D8360	3rd position pulse amount	Low
D8080	X1 Rising edge ring counter value	Low	D8361		High
D8081	[1/6μs unit]	High	D8362	Y2 deviation speed Initial value:0	
D8082	X1 falling edge ring counter value	Low	D8363	3rd pulse maximum speed	Low
D8083	[1/6μs unit]	High	D8364	Y2 crawling speed Initial value: 1000	High
D8084	X1 pulse width / pulse period	Low	D8365	Y2 Origin return speed Initial value:50000	Low
D8085	[10μs unit]	High	D8366		High
D8086	X3 Rising edge ring counter value	Low	D8367		
D8087	[1/6μs unit]	High	D8368	3rd pulse acceleration time	
D8088	X3 falling edge ring counter value	Low	D8369	3rd pulse deceleration time	
D8089	[1/6μs unit]	High	D8370	4th position pulse amount	Low
D8090	X3 pulse width / pulse period	Low	D8371		High
D8091	[10μs unit]	High	D8372	Y3 deviation speed Initial value:0	
D8092	X4 Rising edge ring counter value	Low	D8373	4th pulse maximum speed	Low
D8093	[1/6μs unit]	High	D8374		High
D8094	X4 falling edge ring counter value	Low	D8375	Y3 crawling speed Initial value:1000	
D8095	[1/6μs unit]	High	D8376	Y3 Origin return speed Initial value:50000	Low
D8096	X4 pulse width / pulse period	Low	D8377	High	
D8097	[10μs unit]	High	D8378	4th pulse acceleration time	
D8101	PLC type and system version		D8379	4th pulse deceleration time	
D8102	PLC memory capacity	16...16K Steps	D8395	ADPRW command serial port positionNetwork setting function	refer to chapter 8.6
D8108	Number of connected special modules		D8397		refer to chapter 8.2
D8109	Y number where the output refresh error occurred		D8398	0~2147483647(1ms) Ring count for incremental actions	
D8120	Modbus RTU protocol Communication parameters		D8399		
D8121	Master/Slave station number		D8400	Modbus RTU protocol Communication parameters	Serial Port 3, refer to chapter 8.3
D8122	RS command to receive points monitoring RS command to send data remaining points	Serial Port 2, refer to chapter 8.2	D8401	Communication mode	
D8123			D8406	overtime timeNumber of interval period	
D8124	RS header <initial value: STX>		D8409		
D8125	RS trailer <initial value: ETX>		D8410	RS2 header 1, 2 <initial value: STX>	
D8126	Serial port 2 interval period number		D8411	RS2 header 3, 4	
		D8412	RS2 trailer 1, 2 <initial value:		

Num	Content	Remarks	Num	Content	Remarks
				ETX>	
D8127	Specify the number of data requested by the lower computer communication	Serial Port 2, refer to chapter 8.2	D8413	RS2 trailer 3, 4	
D8128	Specify the starting number of the communication request of the lower computer		D8414	Master / slave station number	
D8129	Set timeout		D8415	RS2 receives the summation calculation result	
D8140	5th position pulse amount	Low	D8416	RS2 sends summation	
D8141		High	D8420	Communication parameters	CAN communication Refer to chapter 8.6
D8142	6th position pulse amount	Low	D8421	Communication mode	
D8143		High	D8426	Number of interval period	
D8144	7th position pulse amount	Low	D8429	overtime time	
D8145		High	D8430	RS2 header 1, 2 <initial value: STX>	
D8146	5th -8th pulse max speed	Low	D8431	RS2 header 3, 4	
D8147		High	D8432	RS2 trailer 1, 2 <initial value: ETX>	
D8148	5th- 8th pulse acceleration and deceleration time		D8433	RS2 trailer 3, 4	
D8160	8th position pulse amount	Low	D8434	RS2 receives the summation receive data	
D8161		High	D8435	RS2 receives the summation calculation result	
D8169	Restrict access status		D8436	RS2 sends summation	
D8182	Z1 Register contents				
D8183	V1 Register contents				
D8184	Z2 Register contents				
D8185	V2 Register contents				

Specific functions please refer to “Coolmay PLC Instructions Programming Manual V20.81”

## 4. Function Instructions

### 4.1. List of basic logic instructions

Mnemonic	Name	Features	Available devices
LD	Take	Normally open contact logic operation starts	X,Y,M,S,D□.b,T,C
LDI	Negate	Normally closed contact logic operation starts	X,Y,M,S,D□.b,T,C
LDP	Take the rising edge of the pulse	Start of operation to detect rising edge	X,Y,M,S,D□.b,T,C
LDF	Take the falling edge of the pulse	Start of operation to detect falling edge	X,Y,M,S,D□.b,T,C
AND	Versus	Series of normally open contacts	X,Y,M,S,D□.b,T,C
ANI	With reverse	Series of normally closed contacts	X,Y,M,S,D□.b,T,C
ANDP	With pulse rising edge	Detect rising edge series connection	X,Y,M,S,D□.b,T,C
OR	Or pulse rising edge	Normally open contacts in parallel	X,Y,M,S,D□.b,T,C
ORI	Or reverse	Normally closed contacts in parallel	X,Y,M,S,D□.b,T,C
ORP	Or pulse rising edge	Parallel connection detecting rising edge	X,Y,M,S,D□.b,T,C
ORF	Or pulse falling edge	Parallel connection to detect falling edge	X,Y,M,S,D□.b,T,C
ANB	Block with	Series connection of circuit blocks	-
ORB	Block or	Parallel connection of circuit blocks	-
MPS	Push stack	Push onto the stack	-
MRD	Read stack	Read stack	-
MPP	Unstack	Pop the stack	-
INV	Negate	Inversion of operation result	-
MEP	M.E.P	Conduction on rising edge	-
MEF	M..EF	Conduction on falling edge	-
OUT	Output	Coil drive	Y,M,S,D□.b,T,C
SET	Position	Movement retention	Y,M,S,D□.b
RST	Reset	Clear action keeps, register cleared	Y,M,S,D□.b,T,C, D,R,V,Z
PLS	Pulse	Differential output on rising edge	Y,M
PLF	Falling edge pulse	Differential output on falling edge	Y,M
MC	Master	Connection circle command for common series point	Y,M
MCR	Master reset	Instruction to eliminate common series point	-
NOP	No operation	No action	-
END	End	End of the program and I/O and return to the beginning	-

## 4.2. Applied instructions 【Sequence is according to instruct variety】

(Contrast with MITSUBISHI)

Applied instruction can be divided into the following 18 kinds.

1	Data move instructions
2	Data conversion instructions
3	Comparison instructions
4	Arithmetic operation instructions
5	Logical operation instructions
6	Special function instructions
7	Rotate instructions
8	Data operation instructions
9	Data operation instructions
10	Character string operation instructions
11	Program flow control instructions
12	I/O refresh instructions
13	Real time clock control instructions
14	Pulse output/positioning control instructions
15	Serial communication
16	Special block/unit control instructions
17	Extension register/extension file register control instructions
18	Other handy instruct

### 1. Data move instructions

Mnemonic	FNC No.	Function	Support
MOV	12	Move	★
SMOV	13	Shift Move	★
CML	14	Compliment	★
BMOV	15	Block Move	★
FMOV	16	Fill Move	★
PRUN	81	Parallel Run (Octal Mode)	★
XCH	17	Exchange	★
SWAP	147	Byte Swap	★
EMOV	112	Floating Point Move	★
HCMOV	189	High Speed Counter Move	★

### 2. Data conversion instructions

Mnemonic	FNC No.	Function	Support
BCD	18	Conversion to Binary Coded Decimal	★
BIN	19	Conversion to Binary	★
GRY	170	Decimal to Gray Code Conversion	★

GBIN	171	Gray Code to Decimal Conversion	★
FLT	49	Conversion to Floating Point	★
INT	129	Floating Point to Integer Conversion	★
EBCD	118	Floating Point to Scientific Notation Conversion	★
EBIN	119	Scientific Notation to Floating Point Conversion	★
RAD	136	Floating Point Degree to Radian Conversion	★
DEG	137	Floating Point Radian to degree Conversion	★

### 3. Comparison instructions

Mnemonic	FNC No.	Function	Support
LD=	224	Contact compare LD (S1)=(S2)	★
LD>	225	Contact compare LD (S1)>(S2)	★
LD<	226	Contact compare LD (S1)<(S2)	★
LD<>	228	Contact compare LD (S1)≠(S2)	★
LD<=	229	Contact compare LD (S1)≧(S2)	★
LD>=	230	Contact compare LD (S1)≦(S2)	★
AND=	232	Contact compare AND (S1)=(S2)	★
AND>	233	Contact compare AND (S1)>(S2)	★
AND<	234	Contact compare AND (S1)<(S2)	★
AND<>	236	Contact compare AND (S1)≠(S2)	★
AND<=	237	Contact compare AND (S1)≧(S2)	★
AND>=	238	Contact compare AND (S1)≦(S2)	★
OR=	240	Contact compare OR (S1)=(S2)	★
OR>	241	Contact compare OR (S1)>(S2)	★
OR<	242	Contact compare OR (S1)<(S2)	★
OR<>	244	Contact compare OR (S1)≠(S2)	★
OR<=	245	Contact compare OR (S1)≧(S2)	★
OR>=	246	Contact compare OR (S1)≦(S2)	★
CMP	10	Compare	★
ZCP	11	Zone Compare	★
ECMP	110	Floating Point Compare	★
EZCP	111	Floating Point Zone Compare	★
HSCS	53	High speed counter set	★
HSCR	54	High speed counter reset	★
HSZ	55	High Speed Counter Zone Compare	★
HSCT	280	High speed counter table compare	★
BKCMP=	194	Block compare (S1)=(S2)	★
BKCMP>	195	Block compare (S1)>(S2)	★
BKCMP<	196	Block compare (S1)<(S2)	★
BKCMP<>	197	Block compare (S1)≠(S2)	★
BKCMP<=	198	Block compare (S1)≧(S2)	★
BKCMP>=	199	Block compare (S1)≦(S2)	★

#### 4. Arithmetic operation instructions

Mnemonic	FNC No.	Function	Support
ADD	20	Addition	★
SUB	21	Subtraction	★
MUL	22	Multiplication	★
DIV	23	Division	★
EADD	120	Floating Point Addition	★
ESUB	121	Floating Point Subtraction	★
EMUL	122	Floating Point Multiplication	★
EDIV	123	Floating Point Division	★
BK+	192	Block Data Addition	★
BK-	193	Block Data Subtraction	★
INC	24	Increase	★
DEC	25	Decrement	★

#### 5. Logical operation instructions

Mnemonic	FNC No.	Function	Support
WAND	26	Word AND	★
WOR	27	Word OR	★
WXOR	28	Word Exclusive OR	★

#### 6. Special function instructions

Mnemonic	FNC No.	Function	Support
SQR	48	Square Root	★
ESQR	127	Floating Point Square Root	★
EXP	124	Floating Point Exponent	★
LOGE	125	Floating Point Natural Logarithm	★
LOG10	126	Floating Point Common Logarithm	★
SIN	130	Floating Point Sine	★
COS	131	Floating Point Cosine	★
TAN	132	Floating Point Tangent	★
ASIN	133	Floating Point Arc Sine	★
ACOS	134	Floating Point Arc Cosine	★
ATAN	135	Floating Point Arc Tangent	★
RND	184	Random Number Generation	★

#### 7. Rotate instructions

Mnemonic	FNC No.	Function	Support
ROR	30	Rotation Right	★
ROL	31	Rotation Left	★
RCR	32	Rotation right With Carry	★
RCL	33	Rotation Left with Carry	★

## 8. Shift instructions

Mnemonic	FNC No.	Function	Support
SFTR	34	Bit Shift Right	★
SFTL	35	Bit Shift Left	★
SFR	213	Bit Shift Right with Carry	★
SFL	214	Bit Shift Left with Carry	★
WSFR	36	Word Shift Right	★
WSFL	37	Word Shift left	★
SFWR	38	Shift Write [FIFO/FILO Control]	★
SFRD	39	Shift Read [FIFO Control]	★
POP	212	Shift Last Data Read [FILO Control]	★

## 9. Data operation instructions

Mnemonic	FNC No.	Function	Support
ZRST	40	Zone Reset	★
DECO	41	Decode	★
ENCO	42	Encode	★
MEAN	45	Mean	★
WSUM	140	Sum of Word Data	★
SUM	43	Sum of Active Bits	★
BON	44	Check Specified Bit Status	★
NEG	29	Negation	★
ENEG	128	Floating Point Negation	★
WTOB	141	WORD to BYTE	★
BTOW	142	BYTE to WORD	★
UNI	143	4-bit Linking of Word Data	★
DIS	144	4-bit Grouping of Word Data	★
CCD	84	Check Code	★
CRC	188	Cyclic Redundancy Check	★
LIMIT	256	Limit Control	★
BAND	257	Dead Band Control	★
ZONE	258	Zone control	★
SCL	259	Scaling (Coordinate by Point Data)	★
SCL2	269	Scaling 2 (Coordinate by X/Y Data)	★
SORT	69	Sort Tabulated Data	★
SORT2	149	Sort Tabulated Data 2	★
SER	61	Search a Data Stack	★
FDEL	210	Deleting Data from Tables	★
FINS	211	Inserting Data to Tables	★

## 10. String processing instruction

Mnemonic	FNC No.	Function	Support
ESTR	116	Floating Point to Character String Conversion	★
EVAL	117	Character String to Floating Point Conversion	★

STR	200	BIN to Character String Conversion	★
VAL	201	Character String to BIN Conversion	★
DABIN	260	Decimal ASCII to BIN Conversion	★
BINDA	261	BIN to Decimal ASCII Conversion	★
ASCI	82	Hexadecimal to ASCII Conversion	★
HEX	83	ASCII to Hexadecimal Conversion	★
\$MOV	209	Character String Transfer	★
\$+	202	Link Character Strings	★
LEN	203	Character String Length Detection	★
RIGH	204	Extracting Character String Data From the Right	★
LEFT	205	Extracting Character String Data from the Left	★
MIDR	206	Random Selection of Character Strings	★
MIDW	207	Random Replacement of Character Strings	★
INSTR	208	Character string search	★
COMRD	182	Read Device Comment Data	★

## 11. Program flow control instructions

Mnemonic	FNC No.	Function	Support
CJ	00	Conditional Jump	★
CALL	01	Call Subroutine	★
SRET	02	Subroutine Return	★
IRET	03	Interrupt Return	★
EI	04	Enable Interrupt	★
DI	05	Disable Interrupt	★
FEND	06	Main Routine Program End	★
FOR	08	Start a FOR/NEXT Loop	★
NEXT	09	End a FOR/NEXT Loop	★

## 12. I/O refresh instructions

Mnemonic	FNC No.	Function	Support
REF	50	Refresh	★
REFF	51	Refresh and Filter Adjust	★

## 13. Real time clock control instructions

Mnemonic	FNC No.	Function	Support
TCMP	160	RTC Data Compare	★
TZCP	161	RTC Data Zone Compare	★
TADD	162	RTC Data Addition	★
TSUB	163	RTC Data Subtraction	★
TRD	166	Read RTC data	★
TWR	167	Set RTC data	★
HTOS	164	Hour to Second Conversion	★
STOH	165	Second to Hour Conversion	★

#### 14. Pulse output/positioning control instruction

Mnemonic	FNC No.	Function	Support
ABS	155	Absolute Current Value Read	★
DSZR	150	DOG Search Zero Return	★
ZRN	156	Zero Return	★
TBL	152	Batch Data Positioning Mode	★
DVIT	151	Interrupt Positioning	★
DRVI	158	Drive to Increment	★
DRVA	159	Drive to Absolute	★
PLSV	157	Variable Speed Pulse Output	★
PLSY	57	Pulse Y Output	★
PLSR	59	Acceleration/Deceleration Setup	★

#### 15. Serial communication instructions

Mnemonic	FNC No.	Function	Support
RS	80	Serial Communication	★
R(S2)	87	Serial Communication 2	★
IVCK	270	Inverter Status Check	
IVDR	271	Inverter Drive	
IVRD	272	Inverter Parameter Read	
IVWR	273	Inverter Parameter Write	
IVBWR	274	Inverter Parameter Block Write	
IVMC	275	Inverter multiple command	
ADPRW	276	MODBUS read and write	★

#### 16. Special block/unit control instructions

Mnemonic	FNC No.	Function	Support
FROM	78	Read From a Special Function Block	★
TO	79	Write To a Special Function Block	★
RD3A	176	Read form Dedicated Analog Block	★
WR3A	177	Write to Dedicated Analog Block	★
RBFM	278	Divided BFM Read	
WBFM	279	Divided BFM Write	

#### 17. Extension register/extension file register control instructions

Mnemonic	FNC No.	Function	Support
LOADR	290	Load From ER	
SAVER	291	Save to ER	
RWER	294	Rewrite to ER	
INITR	292	Initialize R and ER	
INITER	295	Initialize ER	
LOGR	293	Logging R and ER	

**18. Other handy instructions**

<b>Mnemonic</b>	<b>FNC No.</b>	<b>Function</b>	<b>Support</b>
WDT	07	Watchdog Timer Refresh	★
ALT	66	Alternate State	★
ANS	46	Timed Annunciator Set	★
ANR	47	Annunciator Reset	★
HOUR	169	Hour Meter	★
RAMP	67	Ramp Variable Value	★
SPD	56	Speed Detection	★
PWM	58	Pulse Width Modulation	★
DUTY	186	Timing Pulse Generation	★
PID	88	PID Control Loop	★
ZPUSH	102	Batch Store of Index Register	★
ZPOP	103	Batch POP of Index Register	★
TTMR	64	Teaching timer	★
STMR	65	Special timer	★
ABSD	62	Absolute Drum Sequencer	★
INCD	63	Incremental Drum Sequencer	★
ROTC	68	Rotary Table Control	★
IST	60	Initial state	★
MTR	52	Input Matrix	★
TKY	70	Ten Key Input	★
HKY	71	Hexadecimal Input	★
DSW	72	Digital switch (thumbwheel input)	★
SEGD	73	Seven Segment Decoder	★
SEGL	74	Seven Segment With Latch	★
ARWS	75	Arrow Switch	★
ASC	76	ASCII code data input	★
PR	77	Print (ASCII Code)	★
VRRD	85	Volume Read	★
VRSC	86	Volume Scale	★

## 5. Application of analog

When using, Please notice the difference between Host L02M24 and Expansion analog module.

### 5.1. Analog input

L02 series PLC input accuracy is 12bit, and expansion analog module input accuracy is 16bit. When using, you can directly read the register value corresponding to each analog.

#### 5.1.1. L02M24 Host analog input type

L02M24T/L02M24R has default 4 analog input and 4 analog output; Analog input type:2\*0-10V, 2\*0-20mA(4-20mA).

Input signal	Range	Register value	Resolution	Accuracy (Total Measuring range)
Voltage	0-10V	0~4000	2.5mV	1%
Current Type1	0~20mA	0~4000	5uA	1%
Current Type2	4~20mA	0~4000	4uA	1%

The type of host analog input needs to be set, refer to following table:

Register no	Read value	Type
R23940~R23943	0	0~10V(or 0~20mA)
R23940~R23943	1	4~20mA

#### 5.1.2. L02M24 Host analog input read

L02M24T/L02M24R has default 4 analog input and 4 analog output; Analog input type:2\*0-10V, 2\*0-20mA(4-20mA).

Support FROM instruction or register directly read. Such as: FROM K0 K0 D400 K2 read out 16 analog input, 0-10V.

Registers read values are shown in the following table:

No	AD Register
AD0 (Voltage 1)	D8030
AD1 (Voltage 2)	D8031

AD2 (Current 1)	D8032
AD3 (Current 2)	D8033

When 4-20mA type, Registers read less than 3.8mA, the value is 32760, that is break value.

R23960 starts with a zero correction value and default is 0 (Namely, size correction).

R23980 starts with a negative temperature magnification, and the default is 10000.

The 4 registers starting from R23620 are 0~10V or 0~20mA corresponding values, that is, real-time sampled values.

### 5.1.3. Expansion analog module input type

Input signal	Range	Register value	Resolution	Accuracy (Total Measuring range)	Remark
K-type thermocouple	-230~1370°C	-2300~13700	0.1°C	1%	Thermocouple type requires non-grounded wiring
T-type thermocouple	-230~400°C	-2300~4000	0.1°C	1%	
S-type thermocouple	-40~1690°C	-400~16900	0.1°C	1%	
J-type thermocouple	-90~950°C	-900~9500	0.1°C	1%	
E-type thermocouple	-110~730°C	-1100~7300	0.1°C	1%	
PT100	-200~498°C	-2000~4984	0.1°C	1%	
NTC10K (B value:3435)	-48~110°C	-480~1100	0.1°C	1%	
Voltage	0-10V/0-5V	0~32000	0.3mV/0.15mV	1%	
Current Type1	0~20mA	0~32000	0.6uA	1%	
Current Type2	4~20mA	0~32000	0.5uA	1%	

### 5.1.4. Expansion analog module input read

If the host analog does not meet your project requirements, you can also directly connect the analog expansion module (maximum 12 units can be

expanded), such as L02-4AD/L02-4AD2DA, etc.

Among them, D8055 is the number of analog input words; the address is directly assigned, and the read value of the register expanded is shown in the following table:

NO	Register Value
AD0	R23700
AD1	R23701
AD2	R23702
AD3	R23703
...	...
AD48	R23748
AD49	R23749

The type of analog input needs to be set, refer to following table:

Register NO.	Read value	Type	Mark
R23500~R23549	0	0~10V(or 0~20mA); NTC (3435) ; K type thermocouple ; PT100\PT1000	PT cannot be switched; others can be switched to the same type of analog.
R23500~R23549	1	4~20mA;	
R23500~R23549	3	10K NTC (3950)	
R23500~R23549	5	E-type thermocouple	Little difference on thermocouple type, it can still be modified to other thermocouple types after reading the value setting
R23500~R23549	7	T-type thermocouple	
R23500~R23549	9	S-type thermocouple	
R23500~R23549	11	J-type thermocouple	

Remarks: The environmental temperature measuring probe of the temperature analog module is designed on the terminal block of the module, and the value of the corresponding register is the temperature value, which can be directly read and used. If there is a small deviation between the value of the corresponding register and the actual temperature, you can transfer the value of the corresponding register in the program, and then add or subtract to make it close to the actual temperature. If the value of the corresponding

register deviates greatly from the actual temperature, you need to send the module back to the manufacturer for recalibration.

### 5.1.5. Host Analog input sampling

Filtering cycles=( R23600~R23603)\* PLC scanning time, if R23600=1, sample one time each scan circle and change the 1st analog value for one time. The larger R23600~R23603 value is, the result is more stable.

R23600~R23603 is filtering cycles, default is 100 (Range 2~20000);

D8073 is smoothing filter coefficients of all analog input, range: 0~999

### 5.1.6. Analog input program example

#### 5.1.6.1 Host analog input example

Below is an example of the L02 host 1 channel temperature analog AD0 acquisition. The program reads the values as follows:

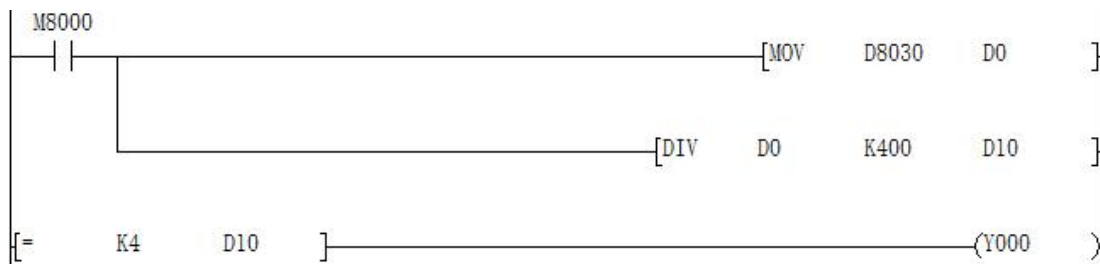

Connect the signal end of the voltage sensor to the AD0 input end of the PLC, and connect the other end to the GND of the analog input port. When the PLC is running, the value of the data register D8030 corresponding to AD0 will be transferred to D0, the value of D0 will be put into D10 after the division operation, the result D10 is the actual voltage input value. In the ladder diagram, you can also directly divide the value of D8030.

**Note: When the input is 0-10V analog, the actual analog value = register reading / 400;**

**When the input is 0-20mA analog, the actual analog value = register**

reading / 200;

**When the input is 4-20 mA analog, the actual analog value = register reading / 250 + 4.**

### 5.1.6.2 Module analog input example

The following example is an example of the first channel temperature analog quantity extended AD0 acquisition of L02, the program read value is as follows:

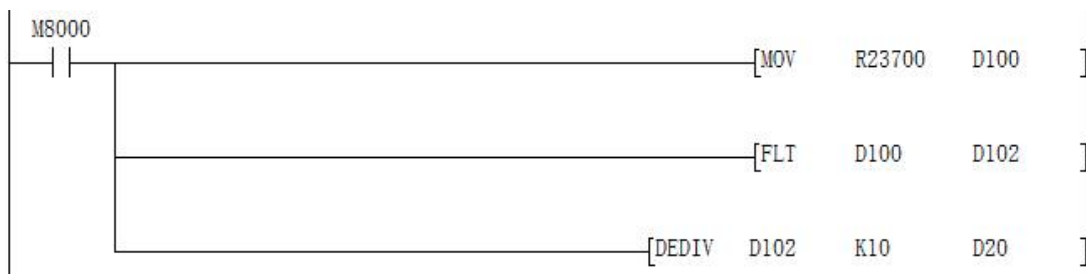

Connect the signal wire of the temperature sensor to the input terminal of the analog module. When the PLC is running, the value of the data register R23700 corresponding to AD0 will be transferred to D100, the value of D100 will be put into D102 after floating-point calculation, and then floating-point division will be performed on D102, the result of the operation will be put into D20, the result D20 is the actual temperature value. In the ladder diagram, you can also directly divide the value of R23700.

#### Note:

**When the input is 0-10V analog, the actual analog value = register reading / 3200;**

**When the input is temperature, the actual temperature value = register reading/10;**

**When the input is 0-20mA analog, the actual analog value = register reading / 1600;**

**When the input is 4-20 mA analog, the actual analog value = register**

reading / 2000 + 4.

## 5.2. Analog output

### 5.2.1. L02M24 Host analog output setting

L02M24T/L02M24R has default 4analog input and 4analog output;Analog output type:2\*0-10V, 2\*0-20mA(4-20mA), analog output setting range is 0-4000, accuracy is 12bit.

Support TO instruction or register assignment operation directly.

Adopts TO K0 K0 D500 K4, 4 channels 0~10V or 0~20mA analog output.

Register assignment operation directly: D8050~D8053.

When the analog output is current, the bit of D8058 needs to be set: when default D8058.0~D8058.7=0, it means 0~20mA; when D8058.0~D8058.7=1, it means 4~20mA.

NO	DA register	Range	Output type
DA0 (Votalge 1)	D8050	0-4000	When D8058.0~D8058.7=0 Indicates 0~20mA; When D8058.0~D8058.7=1 Indicates 4~20mA.
DA1 (Votalge 2)	D8051	0-4000	
DA2 (Current 1)	D8052	0-4000	
DA3 (Current 2)	D8053	0-4000	

### 5.2.2. Expand analog module output setting

If the host analog does not meet your project requirements, you can also directly connect the analog expansion module (maximum 12 units can be expanded), such as L02-4DA/L02-4AD2DA, etc,Optional type can be 0-10V,0-20mA (4-20mA). Analog output setting range is 0-32000, accuracy is 16bit.

Register assignment operation directly: R23750~R23799.

Among them, D8057 is the number of analog input words; the address is directly assigned, and the read value of the register expanded is shown in the following table:

NO	DA register	Range	Output type
DA0	R23750	0-32000	When R23550~R23599=1 Indicates 4~20mA
DA1	R23751	0-32000	
...	...	...	
DA48	R23798	0-32000	
DA49	R23799	0-32000	

### 5.2.3. Host analog output program example

As below, it shows the host 0-10V voltage analog output.



At this point, use a multimeter to check the voltage of the DA0 terminal, that is, the multimeter's red pen is connected to the DA0 terminal, and the black pen is connected to the GND terminal. The multimeter is displaying 5V voltage value.

## 5.3. PID Instruction

### 5.3.1. Outline

This command is used to perform PID control that changes the output value according to the amount of change in the input.

### 5.3.2. PID instruction format and parameter description

Instruction format:

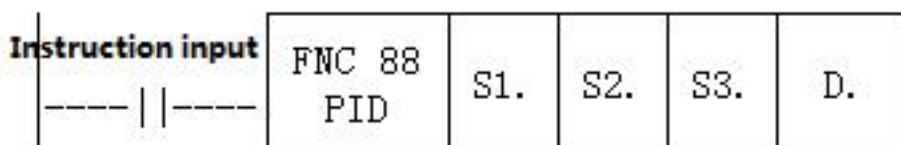

Parameter Description:

Operand Type	Content	Data Type	Word software component
--------------	---------	-----------	-------------------------

S1.	Save data register number of the target value (SV)	BIN16 bit	D,R
S2.	Save data register number of the measured value (PV)	BIN16 bit	D,R
S3.	Save the data register number of the parameter	BIN16 bit	D,R
D.	Save data register number of the output register (MV)	BIN16 bit	D,R

### 5.3.3. Function and action description

16-bit operation (PID): After setting the target value S1., the measured value S2., and the parameters S3~S3+6 in the execution program, the operation result (MV) is saved to the output value D. every sampling time S3.

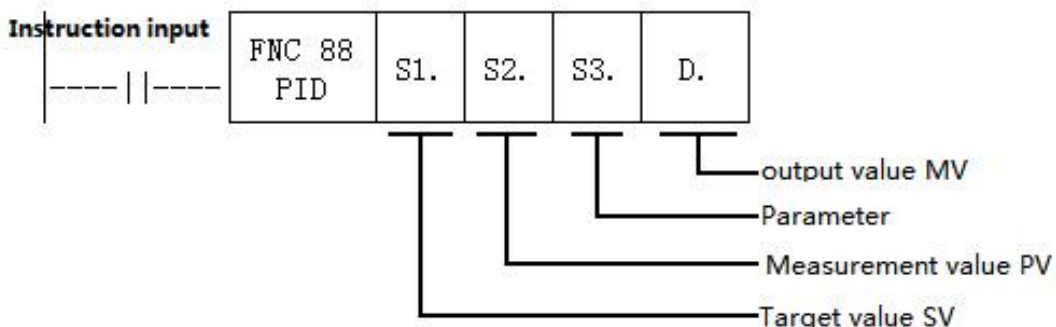

### Setting item

Setting item		Content	Occupied points
S1.	Target value(SV)	Set target value (SV) PID instruction does not change the setting contents	1 point
S2.	Measured value(PV)	The input value of the PID operation	1 point
S3.	Parameter	Auto-tuning: step response method a) ACT setting: when bit1,bit2,bit5 are all not "0",occupy 25points Soft Component starting from the Initial Soft Component specified in S3.	25 points
		b) ACT setting: when bit1,bit2,bit5 are all "0",occupy 20points Soft Component starting from the Initial Soft Component specified in S3.	20 points
DD.	Output value (MV)	Auto-tuning: step response method Set the step output value on the user side before the instruction is driven. During the auto-tuning process, the MV output cannot be changed on the side of the PID instruction.	1 point

### Parameter list S3.~S3.+28

Setting item		Setting content	Remark	
S3.	Sampling time(Ts)	1~32767(ms)	Value shorter than the calculation period can't be run	
S3.+1	ACT	bit0	0: positive action; 1: reverse action.	Action direction (ACT)
		bit1	0: No input change alarm; 1: Input change amount alarm is valid.	
		bit2	0: No output change alarm; 1: Output change amount alarm is valid.	Do not turn ON bit2 and bit5 at the same time
		bit3	Can't use	
		bit4	0: Auto-tuning doesn't work; 1: Perform auto-tuning.	
		bit5	0: No output value upper and lower limit setting; 1: The output value upper and lower limits are valid.	Do not turn ON bit2 and bit5 at the same time
		bit6	0: Step response method.	Auto-tuning mode
		bit7~bit15	Can't use	
S3.+2	Input filter constant ( $\alpha$ )	0~99(%)	0 means no input filtering	
S3.+3	Proportional gain ()	1~32767(%)		
S3.+4	Integration time()	0~32767(*100ms)	0 means as $\infty$ processing (no points)	
S3.+5	Differential gain ()	0~100(%)	0 means no derivative gain	
S3.+6	Derivative time ()	0~32767(*10ms)	0 means no differential processing	
S3.+7 ... S3.+19	PID operation internal processing occupied, please do not change the data.			
S3.+20*1	Input change amount (increase side) alarm set value	0~32767	(ACT): Valid when S3.+1 bit1=1	
S3.+21*1	Input change amount (decrease side) alarm set value	0~32767	(ACT): Valid when S3.+1 bit1=1	
S3.+22*1	Output change amount (increase side) alarm set value	0~32767	(ACT): Valid when S3.+1 bit2=1, bit5=0	
	Output upper limit set value	-32768~32767	(ACT): Valid when S3.+1 bit2=0, bit5=1	
S3.+23*1	Output change amount (decrease side) alarm set value	0~32767	(ACT): Valid when S3.+1 bit2=1, bit5=0	
	Output lower limit set value	-32768~32767	(ACT): Valid when S3.+1 bit2=0, bit5=1	
S3.+24*1	Alarm output	bit0	0: The input change amount (increase side) does not overflow; 1: Input change amount (increase side) overflow.	(ACT): Valid when S3.+1 bit1=1 or bit2=1
		bit1	0: The input change amount (reduction side) does not overflow; 1: Input change amount (reduction side) overflow.	
		bit2	0: The output change amount (increase side) does not overflow; 1: Output change amount (increase side) overflow.	

		bit3	0: The output change amount (reduction side) does not overflow; 1: Output change amount (reduction side) overflow.	
--	--	------	---	--

\*1: When S3+1 action setting (ACT) bit1=1, bit2=1 or bit5=1, S3+20~24 is occupied.

#### 5.3.4. Notice

**When using multiple instructions:** It can be executed multiple times at the same time (the number of loops is not limited), but note that the S3 and D devices used in the operation cannot be repeated.

**Occupied points of parameter S3. :** Step response method

1) ACT setting: when bit1,bit2,bit5 are all not "0",occupy 25points Soft Component starting from the Initial Soft Component specified in S3.

2) ACT setting: when bit1,bit2,bit5 are all "0",occupy 20points Soft Component starting from the Initial Soft Component specified in S3.

**Step response mode:** The self-tuning mode in the PID instruction has only a step response mode, and the step value is S0+22, which is the upper limit value.

**When specifying the soft component in the power failure holding area:** If D. is specified in the program to hold the data register in the power failure, needs to clear the specified register at the time of program start-up.

**Action flag:**

bit 0=0 of S3+1 is positive action, bit0=0 is reverse action;

When heating, is reverse action.

#### 5.3.5. Example

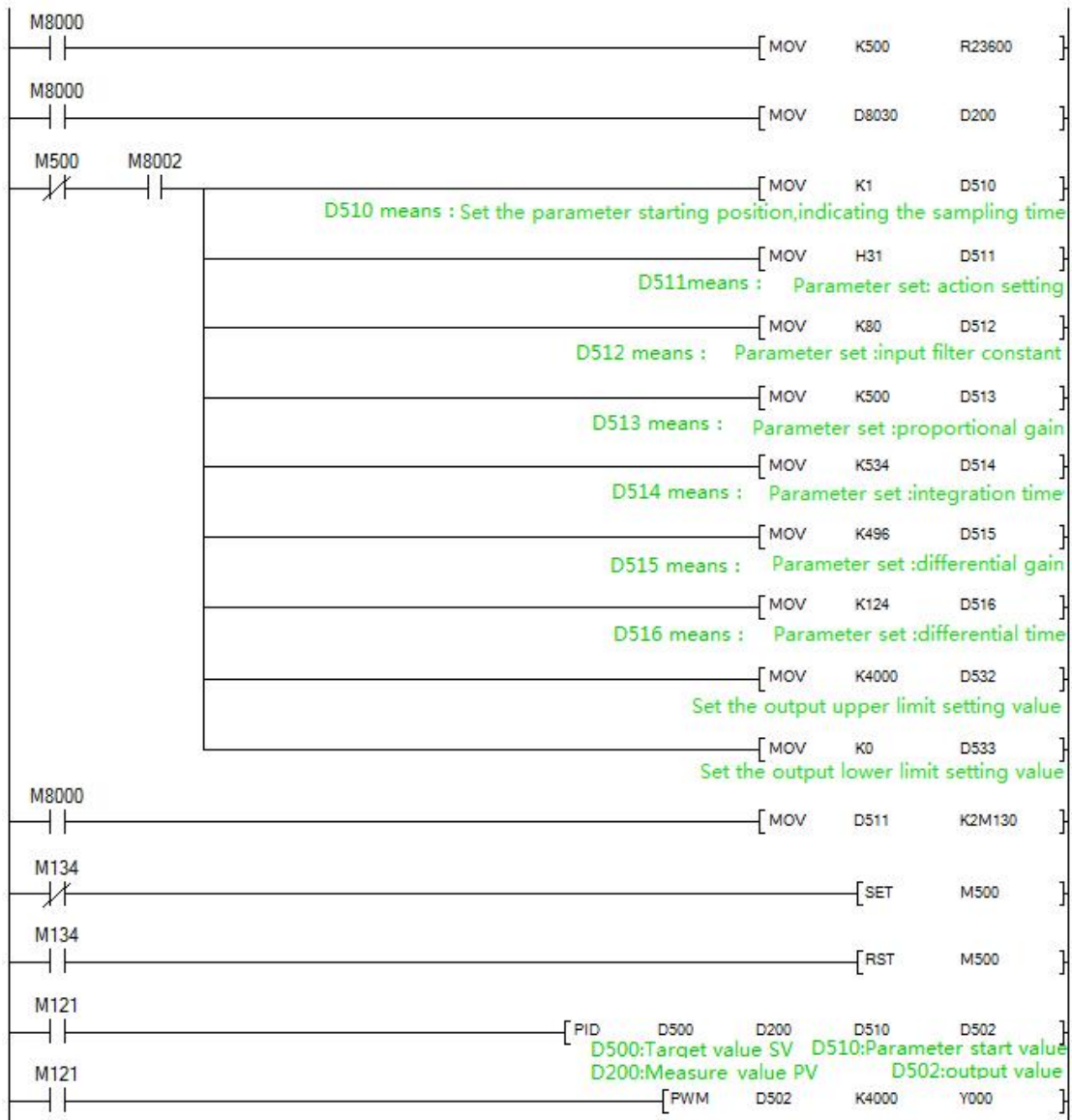

## 6. Application of high speed counter

### 6.1. Assignment table of built-in high speed counter

For L02 series PLC, high speed counter is default as single phase 6 channels 60KHz, or AB(Z) phase 2 channels 30KHz+AB phase 1 channel 5KHz; Among them, AB phase double counter input is default as 1 times frequency.

Counter type	NO	Input assignment							
		X000	X001	X002	X003	X004	X005	X006	X007
Single phase single counter input	C235	U/D							
	C236		U/D						
	C237			U/D					
	C238				U/D				
	C239					U/D			
	C240						U/D		
	C241	U/D	R						
	C242			U/D	R				
	C243					U/D	R		
	C244	U/D	R					S	
	C245			U/D	R				S
Single phase double counter input	C246	U	D						
	C247	U	D	R					
	C248				U	D	R		
	C249	U	D	R				S	
	C250				U	D	R		S
AB phase double counter input	C251	A	B						
	C252	A	B	R					
	C253				A	B	R		
	C254							A	B
	C255				A	B	R		S

U: up counter

D: down counter

A: A phase input

B: B phase input

R: External reset input

S: External start input

**Single phase:** at most 6 channels, max frequency is 60KHz;

**AB phase:**

1 times frequency: at most 2-3 channels, Max frequency is 30KHz;

4 times frequency: at most 2 channels, Max frequency is 24KHz;

## 6.2. Related device

### 1. For switching up/down counting of Single phase single counter

Type	Counter number	Designated device	Up counting	Down counting
Single phase single counter input	C235	M8235	OFF	ON
	C236	M8236		
	C237	M8237		
	C238	M8238		
	C239	M8239		
	C240	M8240		
	C241	M8241		
	C242	M8242		
	C243	M8243		
	C244	M8244		
	C245	M8245		

### 2. For monitoring the up/down counting direction of Single phase

#### double counter and AB phase double counter

Type	Counter number	Designated device	Up counting	Down counting
Single phase double counter input	C246	M8246	OFF	ON
	C247	M8247		
	C248	M8248		
	C249	M8249		
	C250	M8250		
AB phase double counter input	C251	M8251		
	C252	M8252		
	C253	M8253		
	C254	M8254		
	C255	M8255		

### 3. For High-speed counter function switching

Device name	Name	Content
M8198	Function switching device	1 times/4 times switching device for C251/C252
M8199		1 times/4 times switching device for C253/C255

## 7. Application of high speed pulse

### 7.1. high speed pulse output

Coolmay L02 series plc default has 8 channels high speed pulse, Y0-Y3 each 100KHz, Y4-Y7 each 50KHz, variable speed supported, the initial/final speed of start/stop is 0, diagram as below: (take accelerate and decelerate time D8148 as an example).

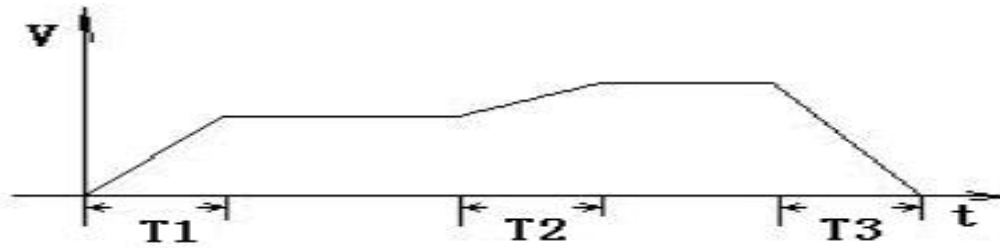

Acceleration/deceleration time T calculation=

$(\text{target speed} - \text{current speed}) \times \text{acceleration} / \text{deceleration time} \div \text{maximum speed}$ .

For example, target speed = 50000, current speed = 20000, acceleration time 100 (ms), maximum speed = 100,000, T = 30 ms.

L02 plc: 8 channels of pulse, the last 4 channels of acceleration and deceleration = D8148, the maximum speed is D8146, D8147.

PLSY, ZRN, PLSV, DRVI, DRVA, DVIT, DSZR, only Y0-Y3 supports DVIT (interrupt positioning), DSZR (origin return with DOG search) instructions.

Pulse point Function Description	Y0	Y1	Y2	Y3	Y4	Y5	Y6	Y7
Pulse operation monitoring	M8340	M8350	M8360	M8370	M8151	M8152	M8153	M8154
Position pulse (32bit)	D8340 D8341	D8350 D8351	D8360 D8361	D8370 D8371	D8140 D8141	D8142 D8143	D8144 D8145	D8160 D8161
Accelerate / decelerate time	D8348 D8349	D8358 D8359	D8368 D8369	D8378 D8379	D8148	D8148	D8148	D8148
Pulse stop bit	M8349	M8359	M8369	M8379	M8450	M8451	M8452	M8453
Maximum speed	D8343 D8344	D8353 D8354	D8363 D8364	D8373 D8374	D8146 D8147	D8146 D8147	D8146 D8147	D8146 D8147

The original FX3G pulse program can be used directly.

All the instruction support 8 channels pulse, except DVIT,DSZR which only support first 4 channels.

## 7.2. Circular interpolation

### 7.2.1. Normal interpolation function

The special flags when setting the interpolation route are as shown in the following table:

Interpolation mode	M8433	M8432
Line Interpolation	0	1
Center interpolation	1	0
Radius interpolation	1	1

The direction and coordinates of the center and radius interpolation are as shown in the following table:

Clockwise	M8435 = 0
Anticlockwise	M8435 = 1
Relative coordinate	M8434 = 0
Absolute coordinate	M8434 = 1

D8340 shows the current address of X axis, D8350 shows the current address of Y axis.

In CoolMay L02 PLC, interpolation motion still adopts DPLSR for pulse output.

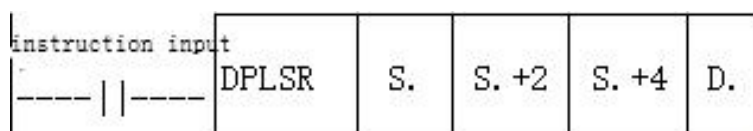

#### Description of the Operand:

S. represents the pulse frequency, that is, the speed of the interpolation motion.

S.+2 represents the X-axis target address.

S.+4 represents the Y-axis target address.

D. specify the Y number with pulse output (Currently only supports Y0, the corresponding direction is Y4; Y1 is another axis, the corresponding direction is Y5).

**In center interpolation mode:**

S.+6 represents the center X coordinate address.

S.+8 represents the center Y coordinate address.

**In radius interpolation mode:**

S.+6 represents the radius length.

When it is positive, the path is a small circle; when it is a negative value, the path is a large circle.

**For example:** DPLSR D100 D102 D104 Y000

**In the linear interpolation:** D100 is speed, D102 is the X-axis target address, and D104 is the Y-axis target address. Y0 and Y1 respectively pulse the X-axis and Y-axis.

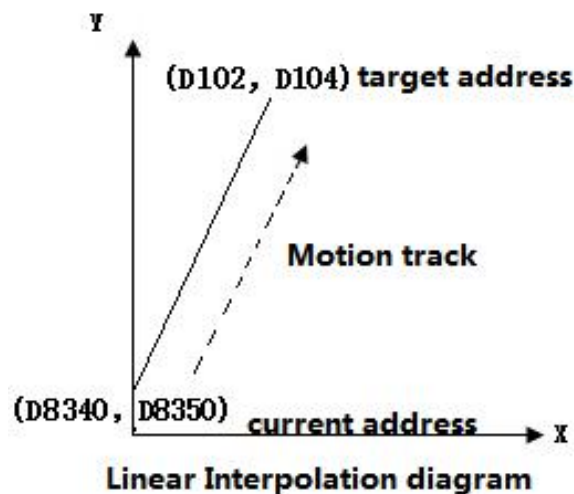

In the Center interpolation: D100 is speed, D102 is the X-axis target address, D104 is the Y-axis target address, and D106 is the center X address. D108 is the center Y address. Y0 and Y1 respectively pulse the X-axis and Y-axis.

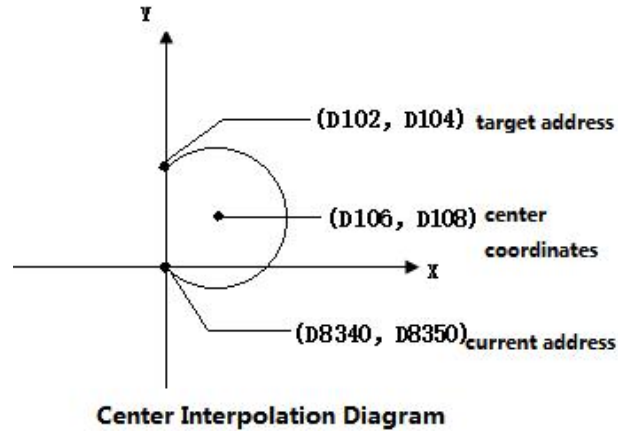

Note 1: The current address of X and Y must be on the same circle as the destination address.

Note 2: When the current address coincides with the target address, it indicates that the motion track is a full circle.

In the radius interpolation: D100 is speed, D102 is the X-axis target address, D104 is the Y-axis target address, and D106 is the radius length. Y0 and Y1 respectively pulse the X-axis and Y-axis. (The legend clockwise, i.e. M8435 = 0)

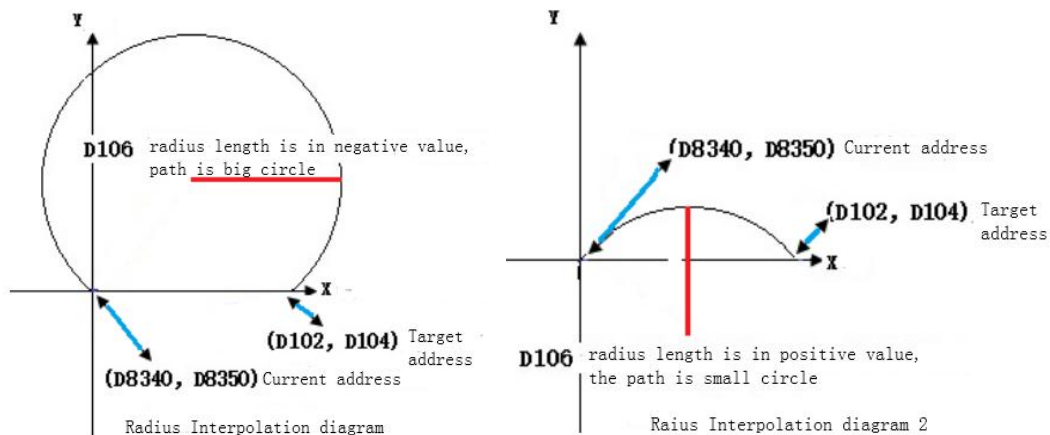

### 7.2.2. Continuous interpolation function

M8436 is the flag for the normal interpolation mode and continuous interpolation mode.

M8436=0: regular interpolation mode;

M8436=1: continuous interpolation mode;

In CoolMay L02 series PLC, continuous interpolation motion uses DPLSR for pulse output.

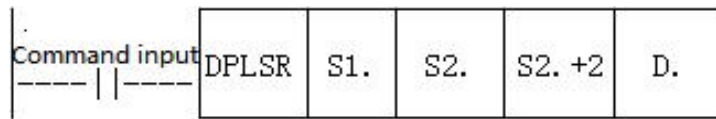

**Operand Description:**All use 32-bit registers.

S1. indicates the pulse frequency, that is, the speed of the interpolation motion.

S2. indicates the X-axis target address.

S2.+2 indicates the Y-axis target address.

In the center mode:

S2.+4 and S2.+6 indicates the Center coordinates.

In radius mode:

S2.+4 indicates the radius length, and S2.+6 ignores and unused.

S2.+4 positive value: the path is a small circle; S2.+4 negative value: the path is a big circle.

S2.+8 is the control register.

D.: Specify the Y number with pulse output (only Y0 supported, the corresponding direction is Y4; Y1 is another axis, the corresponding direction is Y5).

In continuous interpolation mode, M8432~M8435 are determined by the 5th parameter (ie S.+8).

The function description of each bit of the 32-bit register S2.+8 is as follows:

32bit position	b31~b28	b27~b24	b23~b20	b19~b16	b15~b12	b11~b8	b7~b4	b3~b0
Function	Continuous interpolation, execution and stop Flag position					Position mode	Interpolation direction	Interpolation mode

When S2.+8 is used, it is in hexadecimal. The bit values of each group are as below:

b3~b0	=1: linear mode interpolation =2: center mode interpolation =3: radius mode interpolation
b7~b4	=0: clockwise rotation =1: counterclockwise rotation = any other value: linear mode
b11~b8	=1: relative position =2: absolute position
b31~b12	=00000: continuous interpolation execution =AAAAA: continuous interpolation stop

PS: When using linear mode interpolation, b7~b4 is ignored and can be set to any value from 2~F.

S1. and S2. may be set discontinuous. For example, S1.=D100, S2.=D120.

S2. Must be consecutive with the next four 32-bit registers. For example, it must be set to D102, D104, D106, D108, D110.

For example: draw a line and two arcs, as shown:

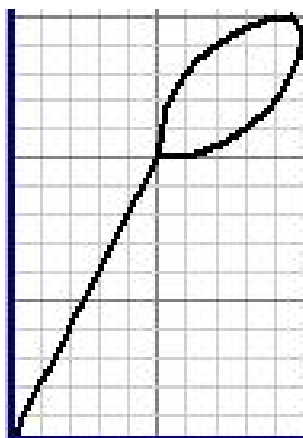

Program as below :

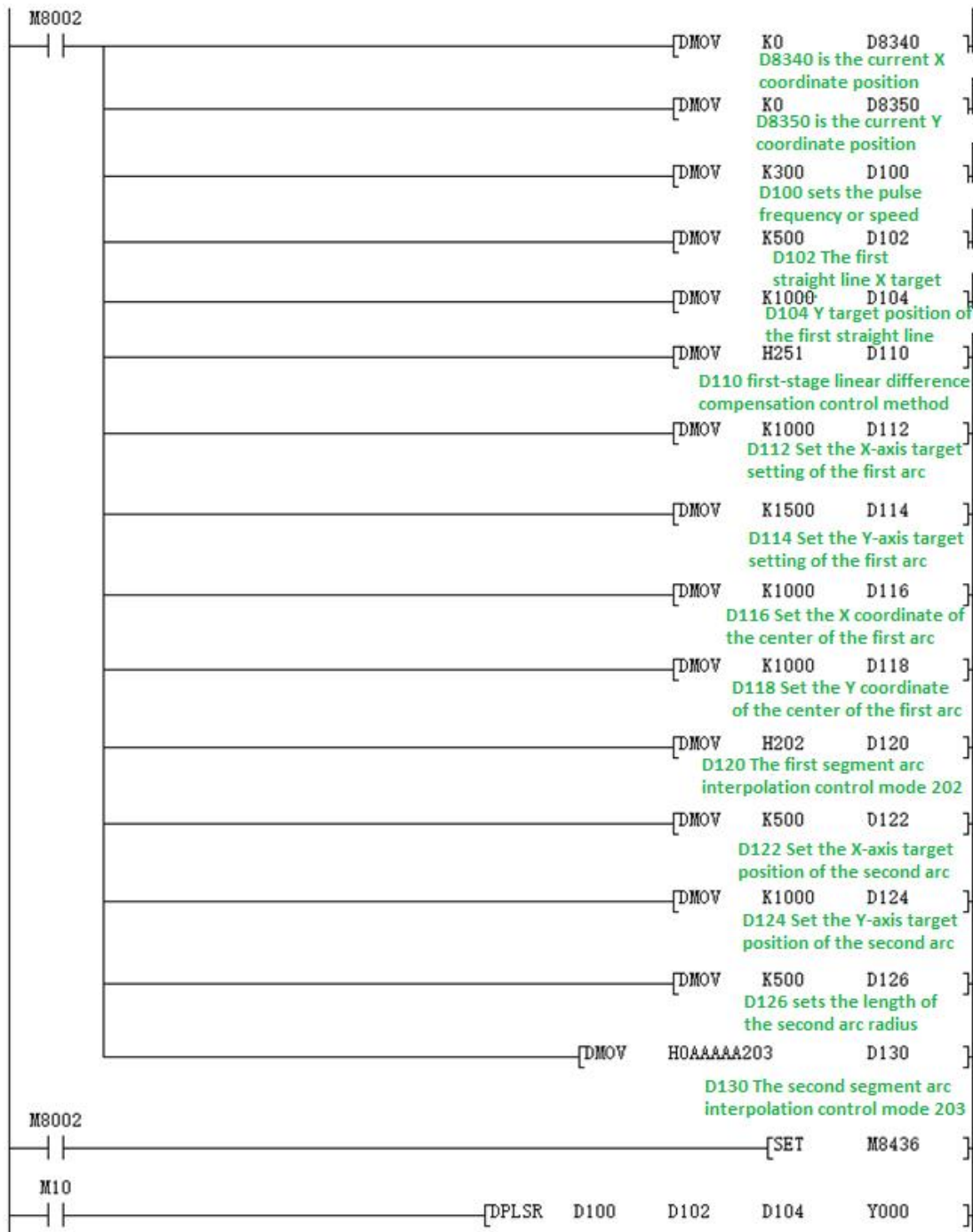

### 7.3. Pulse width modulation PWM

1. Summary: This instruction is used to specify pulse output with pulse period and ON time.
2. PWM instruction format and parameter description.

Instruction format:

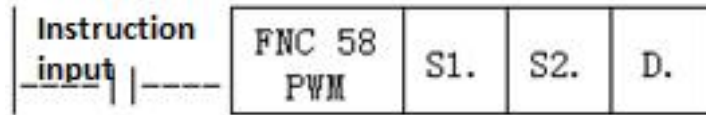

Parameter description:

Operand type	Content	Type of data	Character device	Ranges
S1.	Pulse width (ms) data or word device number for storing data	BIN16 bit	KnX、KnY、KnM、KnS、T、C、D、R、V、Z、K、H	0~32767ms
S2.	Cycle (ms) data or word device number for storing data	BIN16 bit	KnX、KnY、KnM、KnS、T、C、D、R、V、Z、K、H	1~32767ms
D.	Output pulse device (Y) number	BIN16 bit	Y0-Y7	Y0-Y7

### 3. Description of functions and actions

16-bit operation (PID): output pulses with an ON pulse width of [S1.ms] in units of cycle [S2.ms].

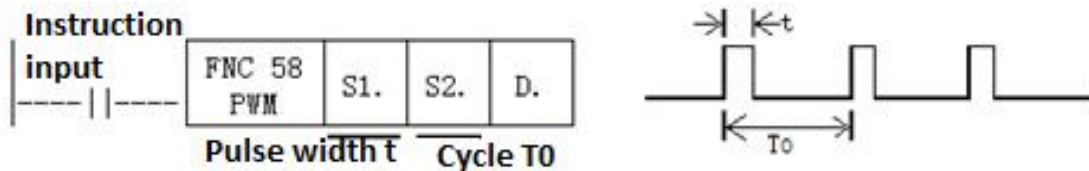

Pay attention to the points

The values of pulse width S1. and period S2. should be set as  $S1. \leq S2.$

When the command input is OFF, the output from D. is also OFF.

Do not operate the setting switch of the pulse output mode during pulse sending.

### 4. Sample program

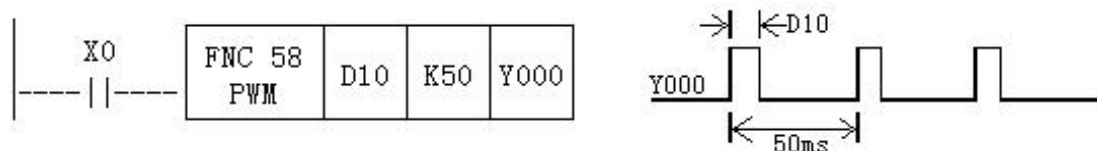

In this example, the data range of D10 is changed from 0 to 50, and the average output of Y0 is 0 to 100%. If the data of D10 is greater than 50, an error will occur.

Example of smooth loop:

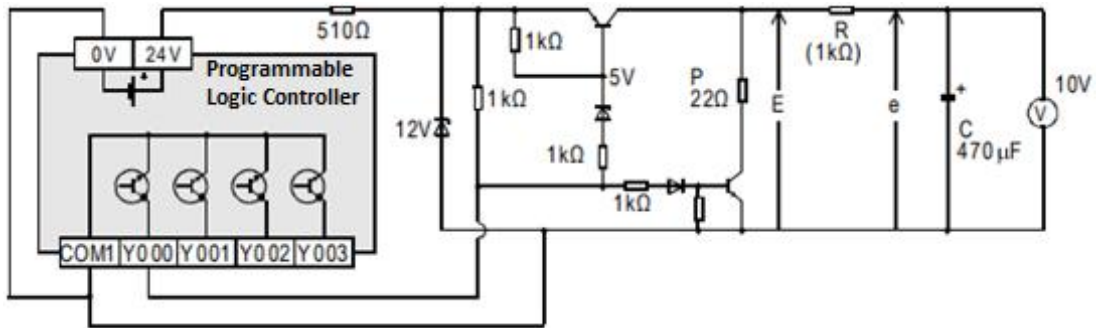

$R \gg P$

$t = R(K\Omega) * C(\mu F) = 470ms \gg T_0$

The time constant  $\tau$  of the filter is a very large value compared to the pulse period  $T_0$ .

The fluctuation value  $\Delta e$  in the average output current  $e$  is approximately

$$\frac{\Delta e}{e} \approx \frac{T_0}{\tau}$$

## 5. Special instructions

### Conventional PWM

- 1) Support a total of 8 channels Y0-Y7 (please select transistor MT output);
- 2) There is no limit to the pulse width and pulse period, both in milliseconds (ms).

### Special customized PWM -- as Analog output

The following parameters are required for model selection:

- 1) the output voltage of the required PWM;
- 2) the output frequency of the required PWM;
- 3) Confirm the numbers of customized PWM, up to 4 PWMs. (depending on analog outputs that customer make).
- 4) Whether the customized PWM coexists with other analog. (If the product is separately equipped with analog, the analog output terminals DA0~DA3 are a group, and DA4~DA7 are a group. When L02 customizes the PWM, the

output frequency can only be installed in a group with other analogs when the output frequency is only 21KHz. ).

### Special customized PWM -- Output frequency setting

When special customize PWM, don't need to use the PWM instruction. You only need to set the special register and then turn on the hardware.

The special registers used for each analog, check below table:

Analog output address	DA0	DA1	DA2	DA3
Duty cycle setting	D8050	D8051	D8052	D8053
Frequency (32 bits)	D8268	D8268	D8268	D8268

D8050 to D8053: the corresponding duty cycle, the value range is 0~4000, each 1 is 0.025%, and the total corresponds to 0~100%;

D8268 : the value range is 1~100000Hz (32 bits);

D8050 to D8053  $\leq$  D8268

When D8268 is powered on, the default setting is 21000Hz, and the power is not maintained. Program assignment is required when using.

## 7.4. Handwheel pulse function

The handwheel pulse generator is commonly known as electronic handwheel and handwheel. It is mainly used for the setting of the teaching CNC machine work origin in CNC machine tools, manual stepping fine adjustment, and interruption insertion during processing. Widely used in CNC engraving and milling machines, CNC milling machines, CNC lathes, machining centers, CNC wire cutting machine tools, CNC EDM machine tools, printing equipment, textile machinery and other fields.

Coolmay L02 series PLC supports the function of handwheel (only supports servo motors, not stepper motors). With the cooperation of L02 PLC, the handwheel is used to control the rotation of the motor, which can realize

the rotation of the handwheel by one pulse and the motor also rotates correspondingly number of pulses.

### Special sign:

M8228: Turn ON to enable the handwheel function (the original C228 function is temporarily not used)

### Instruction format and parameter description when using handwheel.

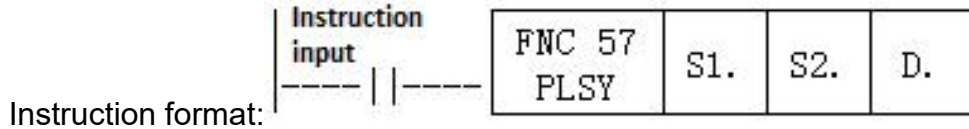

Parameter Description:

Operand type	Content	type of data	Character device
S1.	Set the numerator of the input to output ratio	BIN16 set	K、D
S2.	Set the denominator of the input to output ratio	BIN16 set	K、D
D.	Output pulse device (Y) number	BIN16 set	pulse: Y0-Y5 Corresponding direction: Y10-Y15

PS: When setting S1. and S2., S1. must be an integer multiple of S2. If it is 1:1, it means that the hand wheel rotates one pulse and the motor rotates one pulse; if it is an integer multiple of n, it means that the hand wheel rotates one pulse and the motor rotates n pulses.

The wiring of the handwheel is shown in the figure below:

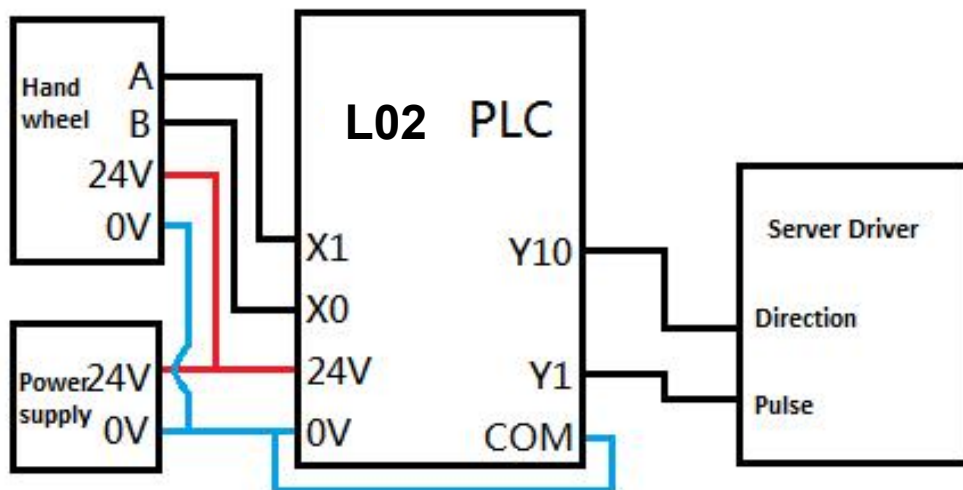

The function program of the hand wheel is shown in the figure below:

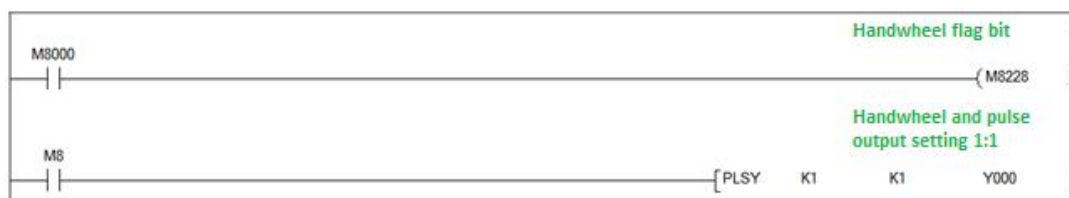

This program is 1:1 pulse output, that is, how many pulses will Y0 output when the handwheel rotates how many pulse.

## 8. Coolmay L02 series PLC communication manual

The L02 series PLC is equipped with a programming port (RS232), two RS485, a CAN port, and a network port to meet the needs of users to connect several types of equipment.

### 8.1. MODBUS instruction explanation and communication address

When PLC is used as the host, it supports ADPRW instruction, RD3A instruction and WR3A instruction. This section explains these three commands.

#### 8.1.1. Function and operation description of read/write data command

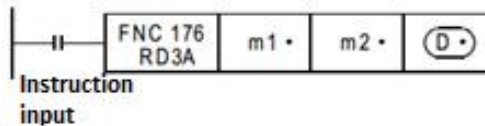

Read data RD3A:

The RD3A instruction corresponds to the No. 03 function of Modbus.

**m1** represents the station number of the read slave device, ranging from 1-247;

**m2** represents the first address number of the read data in the slave device;

**D.** Represents the number of registers to be read, the range is 1-125 (the range is 1-45 in Modbus ASCII, and the range is 1-90 in CAN communication), and the read data are stored in the host D.+1, D. +2.

**D.-1** Address value must be set (=0: serial port 2; =1: serial port 3; =2: CAN; =3: network MODBUS)

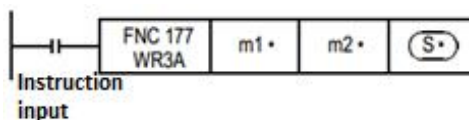

Write data WR3A:

The WR3A instruction corresponds to the No. 06 and No. 10 functions of

Modbus.

**m1** represents the station number of the slave device to be written, ranging from 1-247.

**m2** represents the first address number of the written register in the slave device;

**S.** indicates the number of registers to be written, the range is 1-123 (the range is 1-45 in Modbus ASCII, and the range is 1-90 in CAN communication). The data to be written is sequentially stored in the host S.+1, S.+2.

When S=1, WR3A instruction corresponds to Modbus function 06;

When S=2-123, WR3A instruction corresponds to Modbus No. 10 function;

**S.-1 address value must be set (=0: serial port 2; =1: serial port 3; =2: CAN; =3: network MODBUS)**

**RD3A and WR3A only support the following functions of MODBUS**

**RTU:**

No. 03 function: read the holding register, and obtain the current binary value range 1-125 in one or more holding registers.

No. 06 function: Load the specific binary value into a holding register (write register), the range is 1.

No. 10 function: preset multiple registers, load specific binary values into a series of continuous holding registers (write multiple registers), the range is 1-123.

### **8.1.2. ADPRW instruction function and operation description**

**The ADPRW instruction supports the following functions of MODBUS**

**RTU:**

No. 01 function: read the coil status, get the current status (ON/OFF) of a group of logic coils, the range is 1-512

No. 02 function: read the input status, get the current status (ON/OFF) of a group of switch inputs, the range is 1-512

No. 03 function: read the holding register, obtain the current binary value in one or more holding registers, the range is 1-125

No. 04 function: Get the current binary value in one or more input registers, the range is 1-125

No. 05 function: force a single coil, force a logic coil on-off state (write position), range 1

No. 06 function: load the specific binary value into a holding register (write register), the range is 1

0F function: force setting of multiple coils, force setting of on-off of a series of continuous logic coils (write multiple digits), range 1-1968

No. 10 function: preset multiple registers, load specific binary values into a series of continuous holding registers (write multiple registers), range 1-125

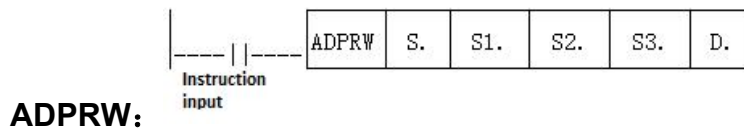

**S.** indicates the station number of the slave device to be read and written, ranging from 1-247;

**S1.** Represents the function code (that is, the 01-06, 15, 16 functions written above);

**S2.** The function parameter corresponding to each function code (for example, the operand represents the start address of MODBUS when the function is 01);

**S3.** The function parameter corresponding to each function code (for example, the operand indicates the number of access points in the 01 function, and the parameter is fixed to 0 in the 05 function);

**D.** Represents the starting position of the data storage device.

### 8.1.3. Word device communication address number

MODBUS device		L02 device
Input register (read only)	Holding register (read/write)	
-	0x0000~0x1F3F	D0~D7999
-	0x1F40~0x213F	D8000~D8511
-	0x2140~0x7EFF	R0~R23999
-	0x7F00~0xA13F	Unused address
-	0xA140~0xA27F	TN0~TN319
-	0xA280~0xA33F	Unused address
-	0xA340~0xA407	CN0~CN199
-	0xA408~0xA477	CN200~CN255
-	0xA478~0xA657	M0~M7679
-	0xA658~0xA677	M8000~M8511
-	0xA678~0xA777	S0~S4095
-	0xA778~0xA78B	TS0~TS319
-	0xA78C~0xA797	Unused address
-	0xA798~0xA7A7	CS0~CS255
-	0xA7A8~0xA7AF	Y0~Y177
0xA7B0~0xA7B7	-	Unused address
0xA7B8~0xA7BF	-	X0~X177
An error occurs when accessing an unused address CN200~255 are 32-bit counters		

### 8.1.4. Bit device communication address number

MODBUS device		L02 device
Input (read only)	Coil (read/write)	
-	0x0000~0x1DFF	M0~M7679
-	0x1E00~0x1FFF	M8000~M8511
-	0x2000~0x2FFF	S0~S4095
-	0x3000~0x313F	TS0~TS319
-	0x3140~0x31FF	Unused address
-	0x3200~0x32FF	CS0~CS255
-	0x3300~0x337F	Y0~Y177
0x3380~0x33FF	-	Unused address
0x3400~0x347F	-	X0~X177
An error occurs when accessing an unused address		

### 8.1.5. ADPRW instruction function parameters

Operand Functions	S1. Function code	S2. MODBUS address/sub function code	S3. Access points/sub function data	D. Data storage device start
Coil readout	1H	MODBUS address: 0000H~FFFFH	Access points: 1~2000	Read target device D.R.M.Y.S
Input readout	2H	MODBUS address: 0000H~FFFFH	Access points: 1~2000	Read target device D.R.M.Y.S
Holding register read	3H	MODBUS address: 0000H~FFFFH	Access points: 1~125	Read target device D.R
Input register read	4H	MODBUS address: 0000H~FFFFH	Access points: 1~125	Read target device D.R
Single coil write	5H	MODBUS address: 0000H~FFFFH	0(fixed)	Write target device D.R.X.Y.M.S 0=bit OFF/1=bit ON
Single register write	6H	MODBUS address: 0000H~FFFFH	0(fixed)	Write target device D.R
Batch coil write	FH	MODBUS address: 0000H~FFFFH	Access points: 1~1968	Write target device D.R.X.Y.M.S
Batch register write	10H	MODBUS address: 0000H~FFFFH	Access points: 1~123	Write target device D.R

### 8.2. Serial port 1: RS232 (PLC programming port)

Support Mitsubishi programming port protocol; can be used to download PLC programs or communicate with devices that support Mitsubishi programming port protocol.

### 8.3. Serial port 2: RS485 (A B)/RS232

Support Mitsubishi programming port protocol, Mitsubishi BD board protocol, free port protocol and MODBUS RTU protocol;

The special relays and special registers involved in this serial port are as follows:

Function Description	Serial port 2 (A/B)	Serial port 3 (A/B)	CAN(H/L)	Remarks
Mitsubishi programming port protocol	M8196=0	M8192=0	-	Power failure does not keep
Freeport protocol function	M8196=1 M8125=0	M8192=1	-	
RS/RS2 send flag	M8122=1	M8402=1	M8422=1	Automatically reset at the

				end of sending
RS/RS2 sending complete flag	-	-	M8425	Need to reset manually
RS/RS2 receiving end flag	M8123	M8403	M8423	Need to reset manually
RS/RS2 receiving process flag	M8124	M8404	M8424	Data is being received
RS/RS2 instruction 8-bit/16-bit distinguishing flag	M8161	M8161	M8161	
Master-slave flag when RS2 command CAN	-	-	M8426	M8426=0 master-slave mode, M8426=1 multi-machine mode
RS2 instruction last operand setting	-	1	2	
MODBUS function	M8196=1 M8125=1	M8192=1	-	
RD3A/WR3A receive correct flag	M8128	M8408	M8428	Automatic reset
RD3A/WR3A communication timeout flag	M8129	M8409	M8429	Automatic reset
ADPRW instruction completion flag	M8029	M8029	M8029	Instruction execution end flag
Communication parameters	D8120	D8400	D8420	
Communication mode	-	D8401	D8421	
Master and slave station number	D8121	D8414	D8434 D8440 D8442	D8434: CAN slave station number D8440\D8442 multi-machine mode ID number
RD3A/WR3A timeout time	D8129	D8409	D8429	The unit is milliseconds, see explanation for detailed settings
RD3A/WR3A interval cycles	D8126	D8406	D8426	
RD3A/WR3A last operand -1	0	1	2	
Set during ADPRW instruction	D8397=0	D8397=1	D8397=2	
CAN data frame	-	-	M8427	

M8196: The activation flag of using programming port protocol and other protocol.

M8125: The activation flag of using MODBUS and the original Mitsubishi function.

M8122: RS command sending flag (this bit needs to be set 1 when using

the RS instruction, ), reset automatically.

M8123: RS command receiving end flag, need to be reset manually.

M8124: RS command data is being received.

M8161: 8-bit/16-bit mode distinguishing flag of RS instruction.

M8128: RD3A/WR3A receives the correct flag and needs to be reset manually.

M8129: RD3A/WR3A communication timeout flag (when communication timeout, the flag bit is ON).

M8029: Communication complete flag (communication complete flag when using ADPRW instruction, manual reset is required).

D8120: Save the communication parameters of Modbus RTU/ASCII protocol. For details, see the setting introduction in the table.

D8121: Save the station number of the master or slave. (This value must be set to the maximum K255 when doing the host)

D8129: RD3A and WR3A timeout time(The unit is milliseconds. It is recommended to set: when the communication rate is set to be greater than or equal to 9600, D8129 is set to 10~20; when the communication rate is set to be less than 9600, D8129 is set to 20~50).

D8126: Number of interval cycles. Default=10 (times).

D8397: When using the serial port 2 for ADPRW instruction, D8397 must be set to 0.

Support RS, WR3A, RD3A, ADPRW instructions. Can be set in the parameter zone, corresponding to serial port 2. The parameter zone settings are only valid for this channel. It is invalid for serial port 3.

### 8.3.1. Mitsubishi programming port

When used as Mitsubishi programming port protocol: set M8196=0.

### 8.3.2. Mitsubishi BD Protocol

When used as the Mitsubishi BD protocol function: set M8196=1, M8125=0; D8120 is set as the communication parameter, and D8121 is set as the slave station number. For example, set D8120=H6086, D8121=H1 (communication parameter is 9600/7/E/1, slave station number is 1).

#### D8120 parameter setting

b1	b1	b1	b1	b1	b1	b	b	b	b	b	b	b	b	b	b
5	4	3	2	1	0	9	8	7	6	5	4	3	2	1	0

b0	Data length 0: 7 bits 1: 8 bits
b1	Parity (b2,b1)
b2	00: None; 01: Odd; 11: Even
b3	Stop bit 0: 1 bit 1: 2 bits
b4	Baud rate (b7,b6,b5,b4)
b5	(0100):600bps    (0101):1200bps    (0110):2400bps
b6	(0111):4800bps    (1000):9600bps    (1001):19200bps
b7	(1010):38400bps    (1011):57600bps    (1101):115200bps
b8	Set 0
b9	
b10	
b11	
b12	Set 0
b13	Set 1
b14	Set 1
b15	Set 0

Example of PLC as slave program:



HMI can communicate with PLC by setting BD protocol master station.

### 8.3.3. Freepoint protocol functions and examples

When used as Mitsubishi Freepoint protocol function: set M8196=1, M8125=0; the difference between Mitsubishi protocol 1 and protocol 4 is that there are end characters 0A 0D (stored in D8124 and D8125 respectively)

For Mitsubishi Freepoint Protocol, RS instruction is supported, the D8120 only needs to set the value of the lower 8 bits.

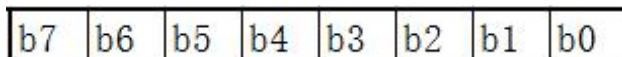

b0	Data length 0: 7 bits 1: 8 bits		
b1	Parity (b2,b1)		
b2	00: None; 01: Odd; 11: Even		
b3	Stop bit		
	0: 1 bit 1: 2 bits		
b4	Baud rate (b7,b6,b5,b4)		
b5	(0100):600bps	(0101):1200bps	(0110):2400bps
b6	(0111):4800bps	(1000):9600bps	(1001):19200bps
b7	(1010):38400bps	(1011):57600bps	(1101):115200bps

Program example:

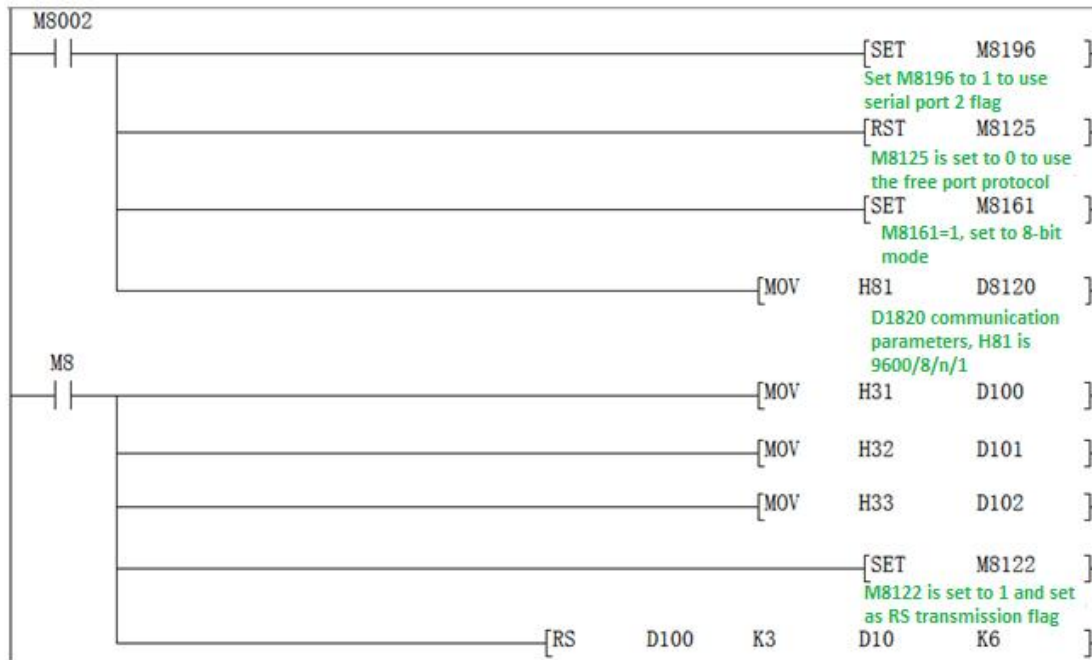

The data obtained by using the serial port tool to monitor the serial port 2 is:

[2019:11:01:10:49:16] [Receive] 31 32 33

### 8.3.4. Modbus RTU protocol

When used as Modbus RTU protocol: set M8196=1, M8125=1; D8120 is set as communication parameter, D8121 is set as slave station number. For example, set D8120=HE081, D8121=H1 (communication parameter is 9600/8/n/1, slave station number is 1).

#### D8120 parameter setting:

b15	b14	b13	b12	b11	b10	b9	b8	b7	b6	b5	b4	b3	b2	b1	b0
-----	-----	-----	-----	-----	-----	----	----	----	----	----	----	----	----	----	----

b0	Data length 0: 7 bits 1: 8 bits
b1 b2	Parity (b2, b1) 00: None; 01: Odd; 11: Even
b3	Stop bit 0: 1 bit 1: 2 bits

b4	Baud rate (b7,b6,b5,b4)		
b5	(0100):600bps	(0101):1200bps	(0110):2400bps
b6	(0111):4800bps	(1000):9600bps	(1001):19200bps
b7	(1010):38400bps	(1011):57600bps	(1101):115200bps
b8	Set 0		
b9			
b10			
b11			
b12	RTU/ASCII mode setting	0:RTU	1:ASCII
b13	Set 1		
b14	Set 1		
b15	Set 1		

**RD3A program example (refer to [chapter 8.1.1](#) for instruction introduction):**

Slave program:

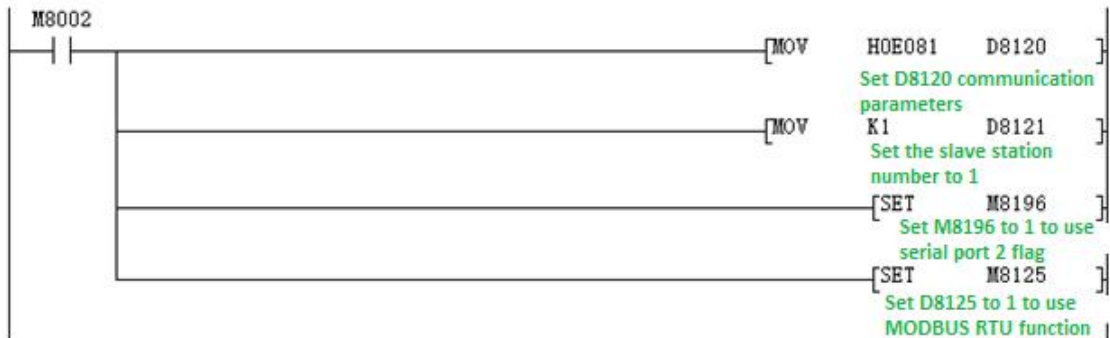

Host program:

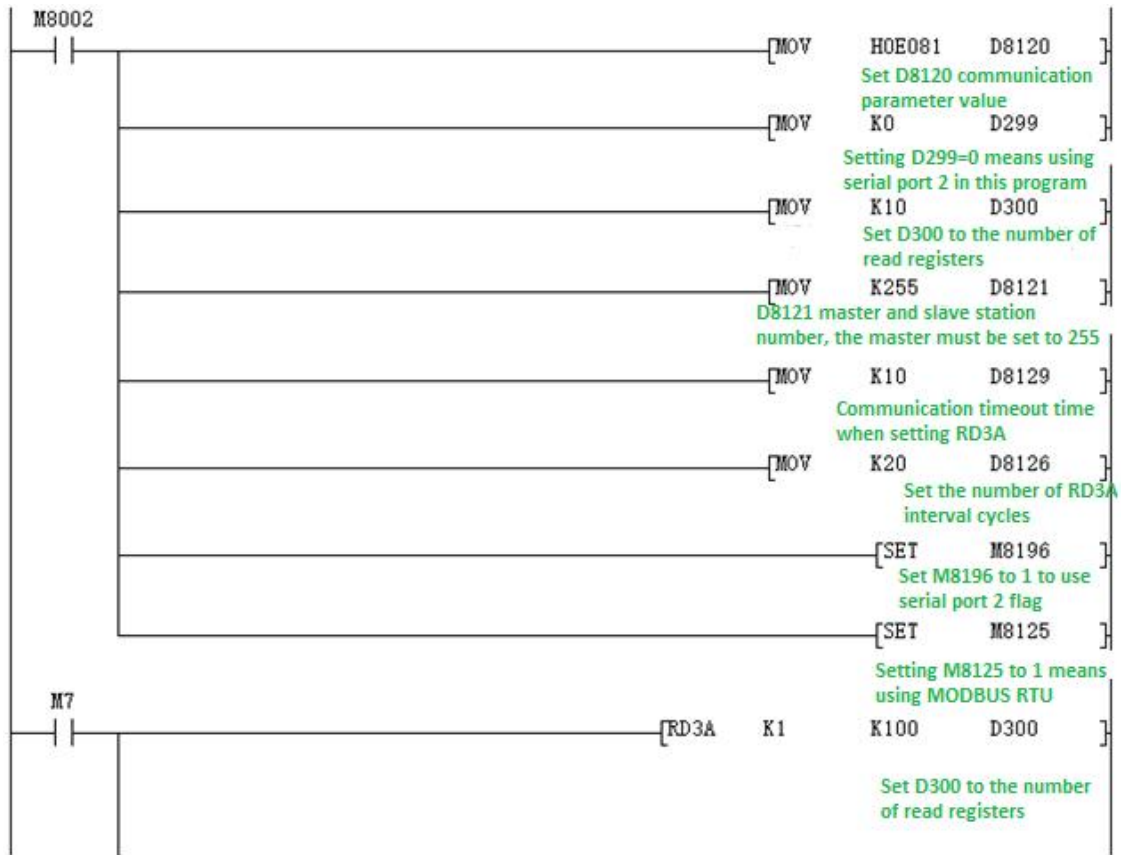

Program explanation:

D300 saves the number of registers read, here it means reading 10 data.

When using serial port 2, **D.-1**, here **D299** must be set to 0.

The program means to read a total of 10 data from registers D100-D109 in the PLC whose slave station is 1, and save them in the registers D301-D310 of the master station PLC.

**WR3A program example (refer to [chapter 8.1.1](#) for instruction introduction):**

Host program:

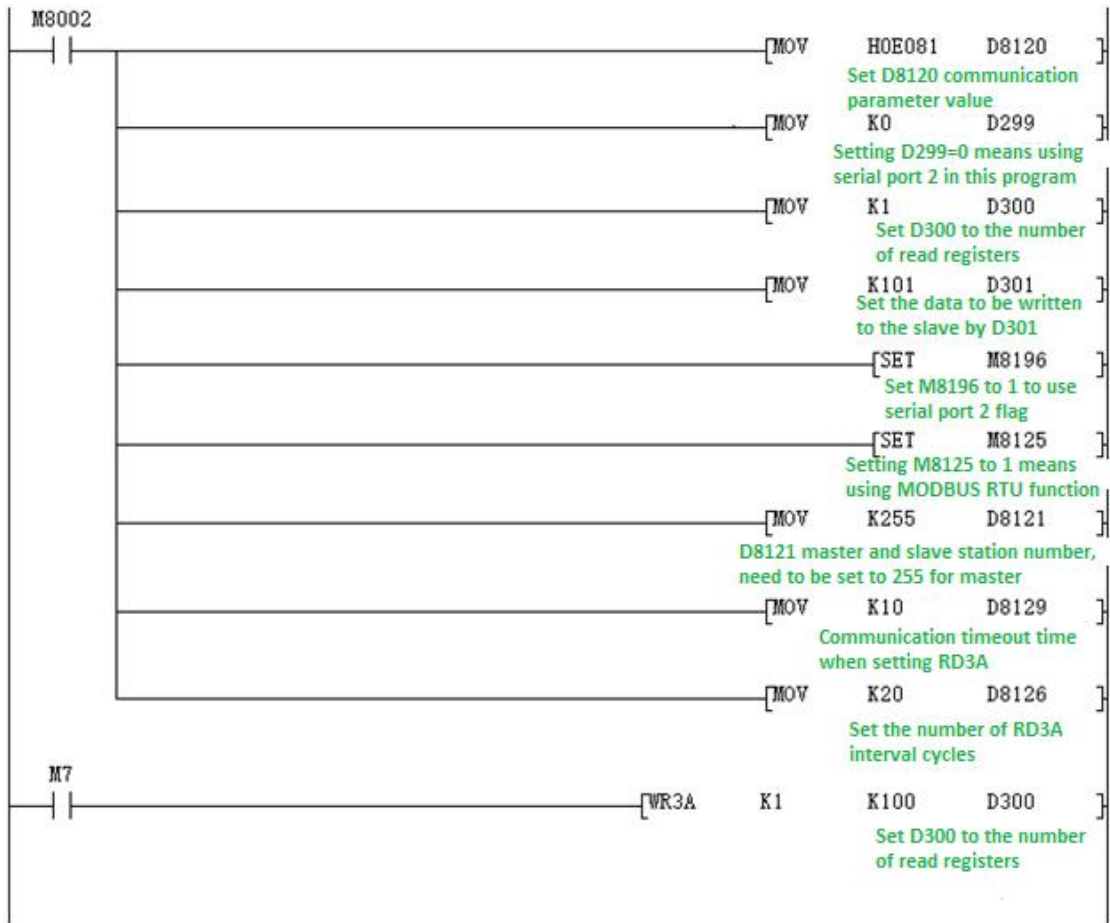

Slave program:

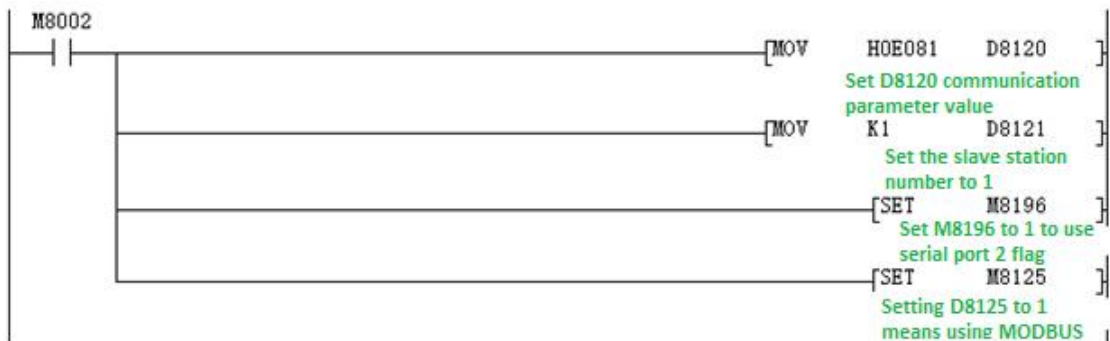

Program explanation:

The program means to write 1 data of register D301 in the master station PLC to the slave station as 1 PLC, and save it in the slave station PLC register D100.

### 8.3.5. Modbus RTU function ADPRW instruction

03 function code holding register output program example(refer to [chapter 8.1.2](#) for instruction introduction)

Host program:

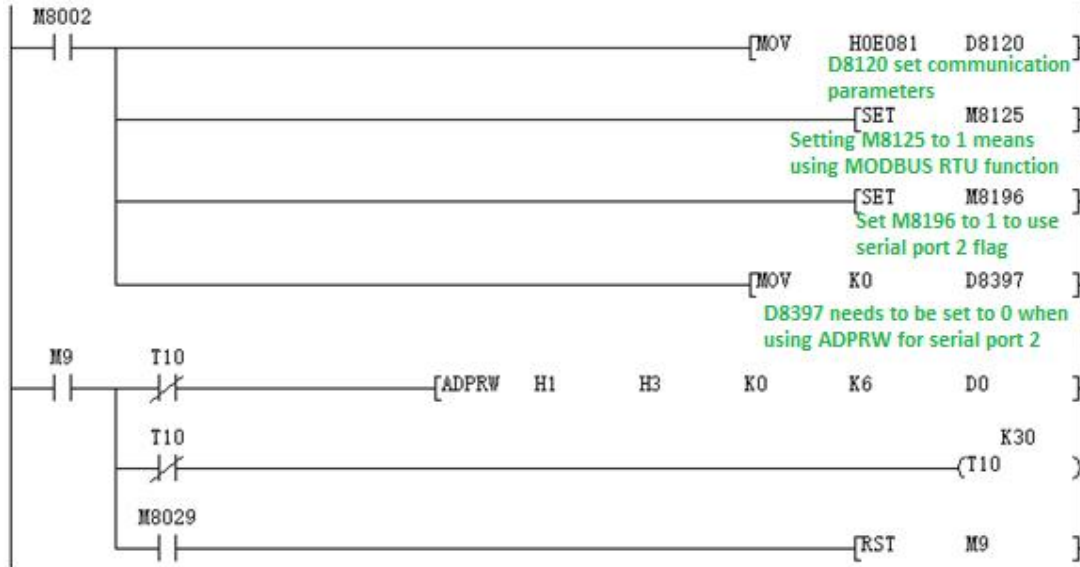

Slave program:

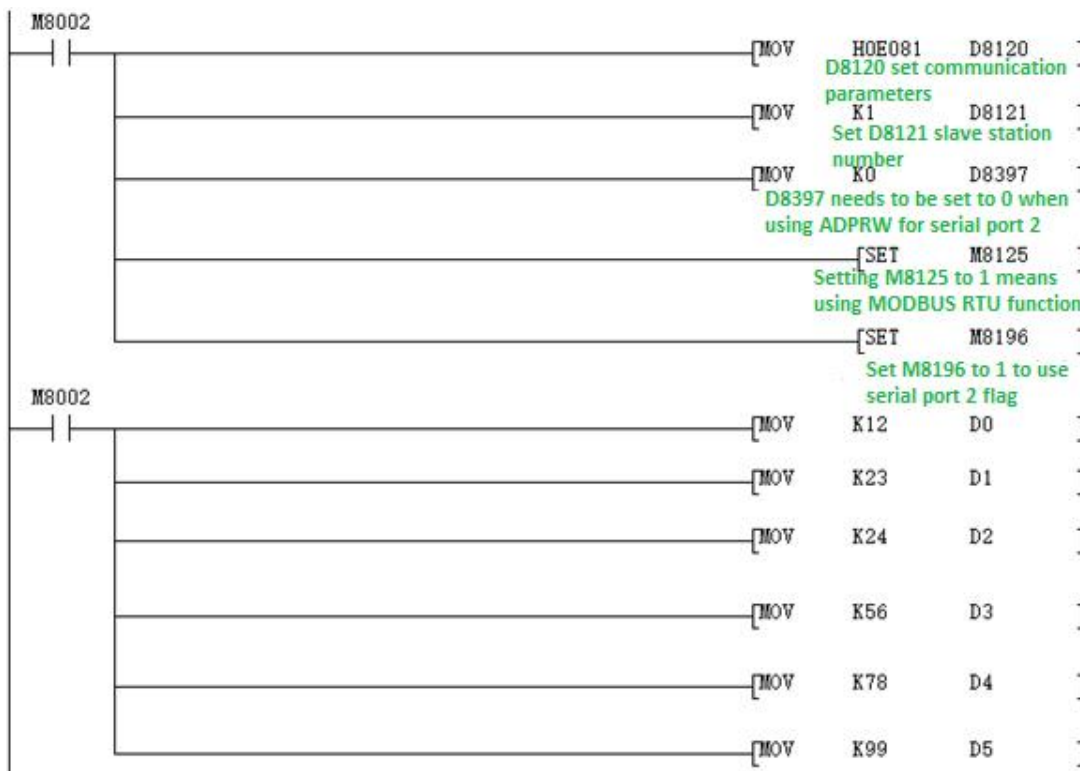

Use the serial port tool to monitor the serial port 2 to get the following data:

[2017:11:01:17:48:54][ receive]01 03 00 00 00 06 C5 C8

[2017:11:01:17:48:54][ receive]01 03 0C 00 0C 00 17 00 22 00 38 00 4E  
00 63 C4 29

### 8.3.6. Modbus ASCII protocol

When used as Modbus ASCII protocol: The specific parameter settings are the same as 8.3.3, only the 12th bit setting of D8120 is different. For specific settings, refer to the introduction of D8120 parameter settings in chapter 8.3.3.

**Note: In modbus ASCII protocol, ADPRW command is not supported.**

Program example:

Host program:

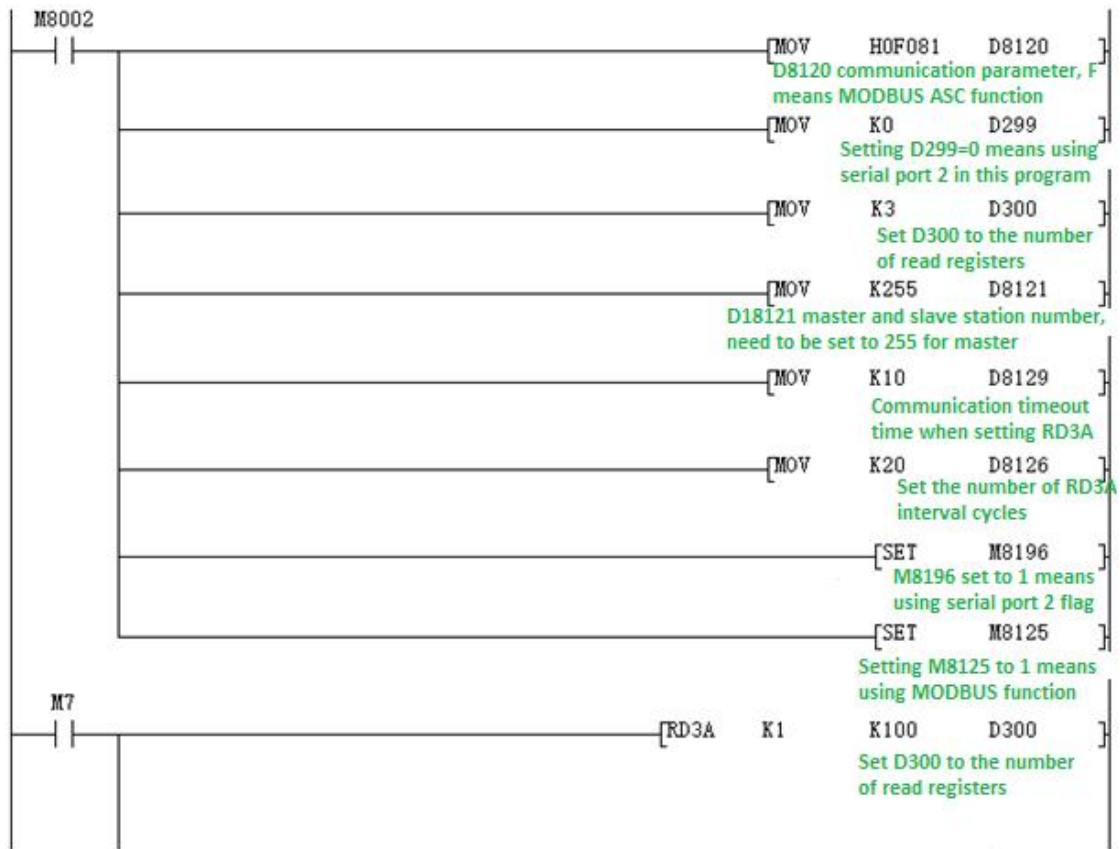

Slave program:



The data display status of the host D300~D303 before and after program execution is shown in the figure below.

Device	+F E D C	+B A 9 8	+7 6 5 4	+3 2 1 0	
D300	0 0 0 0	0 0 0 0	0 0 0 0	0 0 1 1	3
D301	0 0 0 0	0 0 0 0	0 0 0 0	0 0 0 0	0
D302	0 0 0 0	0 0 0 0	0 0 0 0	0 0 0 0	0
D303	0 0 0 0	0 0 0 0	0 0 0 0	0 0 0 0	0
Monitor the data of D300-D301 before the host M7 is turned on					
Device	+F E D C	+B A 9 8	+7 6 5 4	+3 2 1 0	
D300	0 0 0 0	0 0 0 0	0 0 0 0	0 0 1 1	3
D301	0 0 0 0	0 0 0 0	0 0 1 0	0 0 1 1	35
D302	0 0 0 0	0 0 0 0	0 0 1 0	0 1 0 0	36
D303	0 0 0 0	0 0 0 0	0 0 1 0	0 1 0 1	37
D304	0 0 0 0	0 0 0 0	0 0 0 0	0 0 0 0	0
Data of D300-D303 after M7 is turned on					

### 8.4. Serial port 3: RS485 (A1 B1)

Support Mitsubishi programming port protocol, RS2 protocol and MODBUS RTU protocol

The special relays and special registers involved in this serial port are as follows:

Function Description	Serial 2(A/B)	Serial 3(A1/B1)	CAN(H/L)	Remarks
Mitsubishi programming port	M8196=0	M8192=0	-	Power failure does not keep
Freeport protocol function	M8196=1 M8125=0	M8192=1	-	
RS/RS2 sending flag	M8122=1	M8402=1	M8422=1	Automatically reset at the end

				of sending
RS/RS2 sending complete flag	-	-	M8425	Need to reset manually
RS/RS2 receiving end flag	M8123	M8403	M8423	Need to reset manually
RS/RS2 receiving process flag	M8124	M8404	M8424	Data is being received
RS/RS2 instruction 8-bit/16-bit distinguishing flag	M8161	M8161	M8161	
Master-slave flag when RS2 command CAN	-	-	M8426	M8426=0 master-slave mode M8426=1 multi-machine mode
RS2 instruction last operand setting	-	1	2	
MODBUS RTU function	M8196=1 M8125=1	M8192=1	-	
RD3A/WR3A receive correct sign	M8128	M8408	M8428	Automatic reset
RD3A/WR3A communication timeout flag	M8129	M8409	M8429	Automatic reset
ADPRW instruction completion flag	M8029	M8029	M8029	Instruction execution end flag
Communication parameters	D8120	D8400	D8420	
Communication mode	-	D8401	D8421	
Master and slave station number	D8121	D8414	D8434 D8440 D8442	D8434: CAN slave station number D8440\D8442 multi-machine mode ID number
RD3A/WR3A timeout time	D8129	D8409	D8429	The unit is milliseconds, see explanation for detailed settings
RD3A/WR3A interval cycles	D8126	D8406	D8426	
RD3A/WR3A last operand -1	0	1	2	
Set during ADPRW instruction	D8397=0	D8397=1	D8397=2	
CAN data frame	-	-	M8427	

M8192: Use the programming port protocol and the enable flag of other protocols.

M8402: Send flag (used in RS2 command).

M8403: Communication end flag (communication end flag when using RS2 instruction, needs to be reset manually).

M8404: Data receiving.

M8408: Communication completion flag (valid when using RD3A and WR3A for MODBUS communication, manual reset is required).

M8409: Communication timeout.

M8029: Communication completion flag (communication completion flag when using ADPRW instruction, manual reset is required).

M8161: 8-bit/16-bit mode distinction flag for RS/RS2 instructions

D8400: Save the communication parameters of Modbus RTU protocol, see the setting introduction in the table for details.

D8401: Save the communication mode of serial port 3.

D8401=H0 means RS2 free communication mode.

For Modbus RTU: D8401=H11 means the PLC is the slave station; D8401=H1 means the PLC is the master station.

For Modbus ASCII: D8401=H111 indicates that the PLC is a slave station; D8401=H101 indicates that the PLC is a master station.

D8406: The number of interval cycles. Default=12 (times).

D8409: Timeout time. (The unit is milliseconds, and it is recommended to set: when the communication rate setting is greater than or equal to 9600, D8409 is set to 10~20; when the communication rate setting is less than 9600, D8409 is set to 20~50).

D8414: Save the station number of the master or slave. (This value must be set to the maximum K255 when doing the host)

D8397: When using ADPRW instruction, use serial port 3, and D8397 must be set to 1.

Support RS2, WR3A, RD3A, ADPRW instructions. Can be set in the parameter area, corresponding to serial port 3. The parameter area setting is only valid for this channel. It is invalid for serial port 2.

#### **D8400 communication parameter format setting:**

b0	Data length 0: 7 bits 1: 8 bits
b1 b2	Parity (b2, b1) 00: None 01: Odd odd 11: Even

b3	Stop bit 0: 1 bit 1: 2 bits
b4 b5 b6 b7	Baud rate (b7,b6,b5,b4) 0100:600bps    0101:1200bps    0110:2400bps 0111:4800bps    1000:9600bps    1001:19200bps 1010:38400bps    1011:57600bps    1100:Not use
b8~b15	Not available, set to 0

#### D8401 communication parameter format setting:

b0	Select protocol 0: Other communication protocol 1: MODBUS protocol
b1~b3	Not available, set to 0
b4	Master/slave setting 0: MODBUS master 1: MODBUS slave
b5~b7	Not available, set to 0
b8	RTU/ASCII mode setting 0: RTU 1: ASCII
b9~b15	Not available, set to 0

#### 8.4.1. Mitsubishi programming port protocol

When used as Mitsubishi programming port protocol: set M8192=0.

#### 8.4.2. Freeport protocol function

When used as Mitsubishi Freeport protocol function: set M8192=1,  
M8402=1;

Program example:

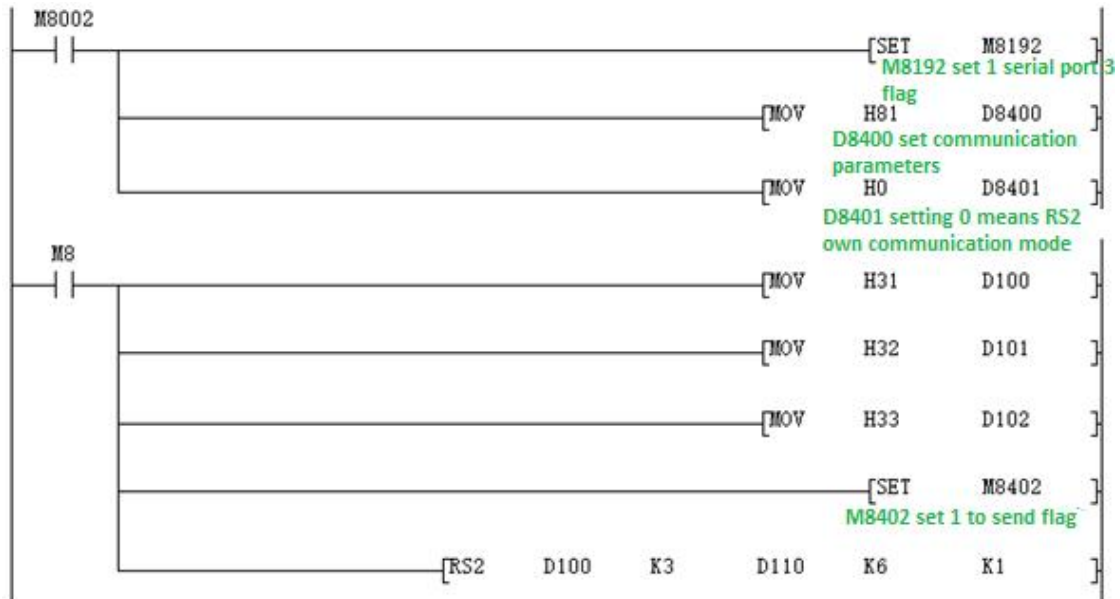

The data obtained by using the serial port tool to monitor the serial port 3 is:

[2017:11:01:11:49:16][ receive]31 32 32

RS2 command last parameter =1: Serial port 3;

=2: CAN.

#### 8.4.3. Modbus RTU function RD3A/WR3A instruction

When used as Modbus RTU protocol: set M8192=1; set D8400 as the communication parameter, and set D8414 as the master and slave station number.

For example, set D8400=H81, D8414=K1 (communication parameter is 9600/8/n/1, slave station number is 1).

**RD3A program example (refer to [chapter 8.1.1](#) for instruction introduction):**

Host program:



Slave program:

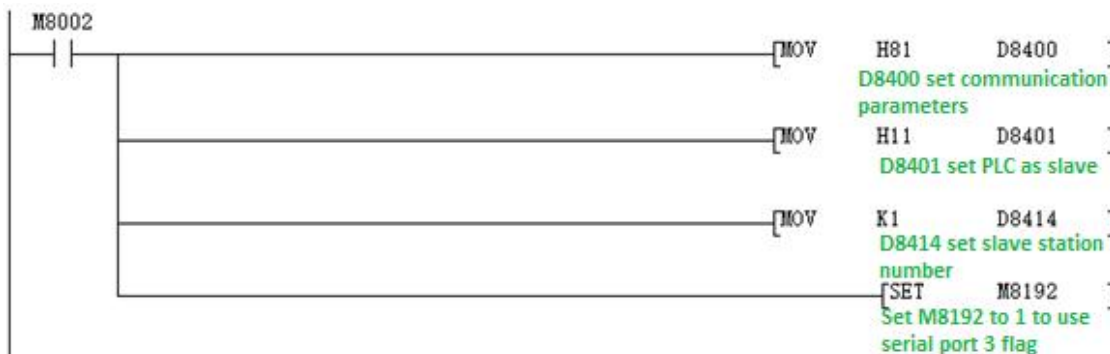

Use the serial port tool to monitor the serial port 3 data, and get the following results:

[2017:11:01:09:00:11][ receive]01 03 00 64 00 0A 84 12

[2017:11:01:09:00:11][ receive]01 03 14 00 42 00 4D 00 58 00 58 00 63 00

37 00 2C 00 21 00 16 00 0B 9F C7

**WR3A program example (refer to [chapter 8.1.1](#) for instruction introduction):**

Host program:

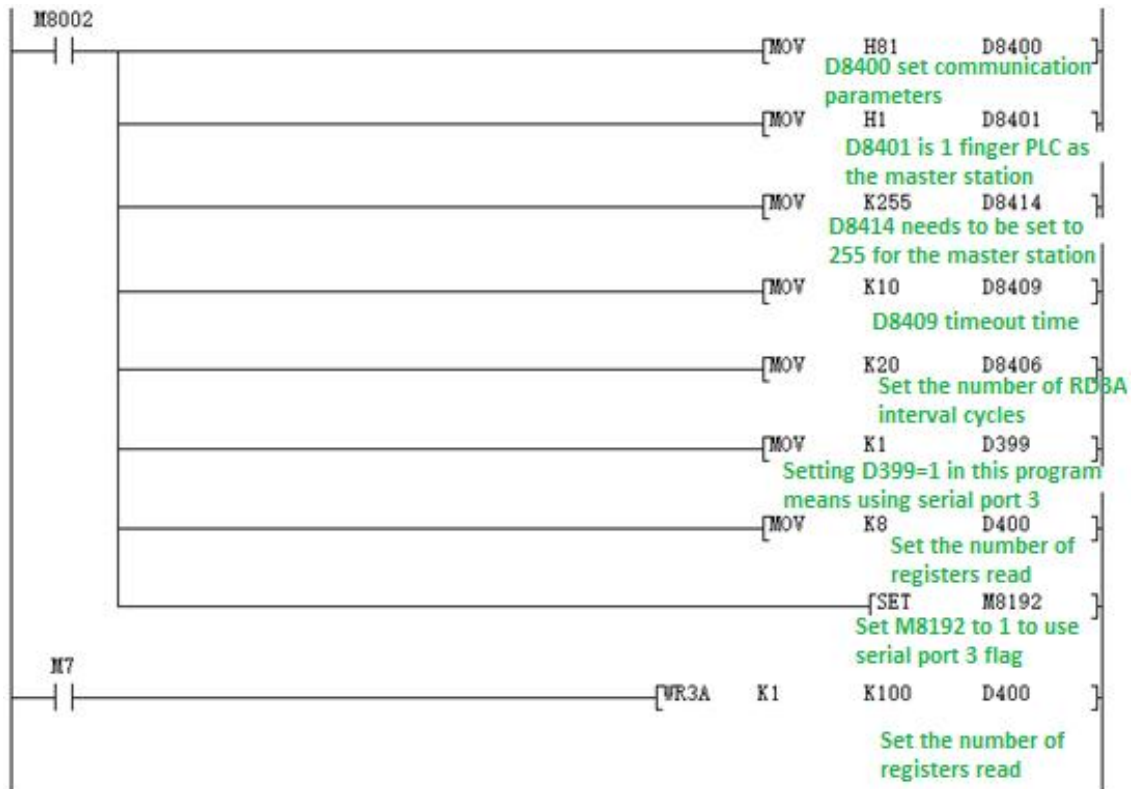

Slave program:

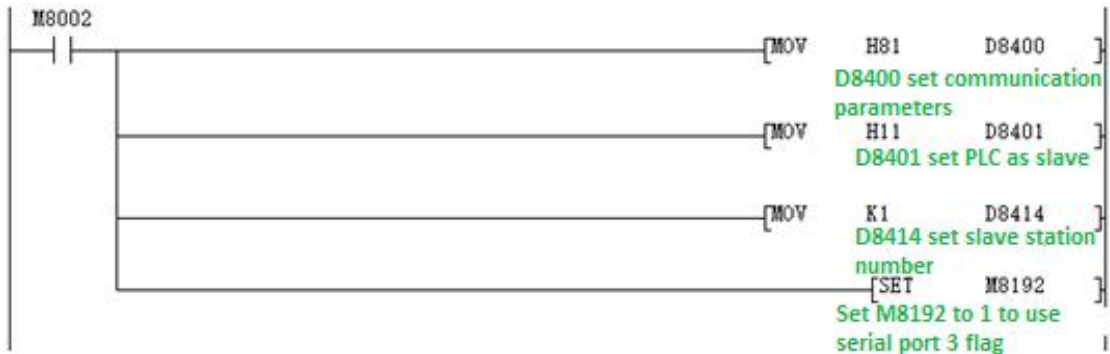

Use the serial port tool to monitor the serial port 3 data, and get the following results:

[2017:11:01:09:25:20][ receive]01 10 00 64 00 08 10 00 0B 00 16 00 21 00  
2C 00 37 00 42 00 4D 00 58 D1 6C

[2017:11:01:09:25:20][ receive]01 10 00 64 00 08 10 00 0B 00 16 00 21 00  
2C 00 37 00 42 00 4D 00 58 D1 6C

### 8.4.4. Modbus RTU Function ADPRW instruction

04 Input register readout demo program (**detail of instruction introduction please refer to [chapter 8.1.2](#)**).

Master program

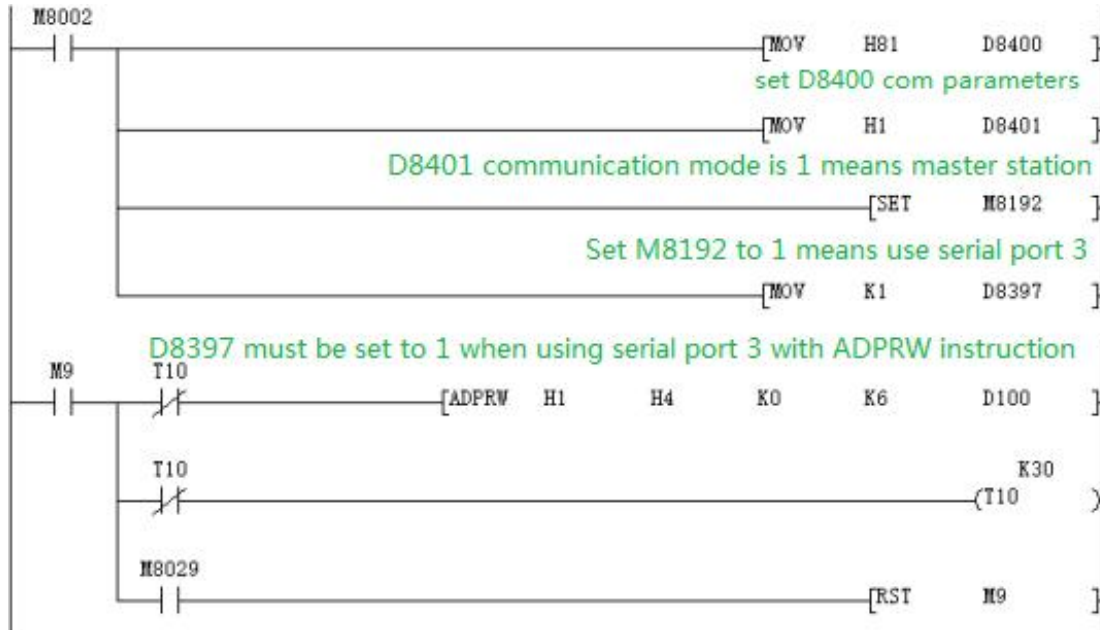

Slave program

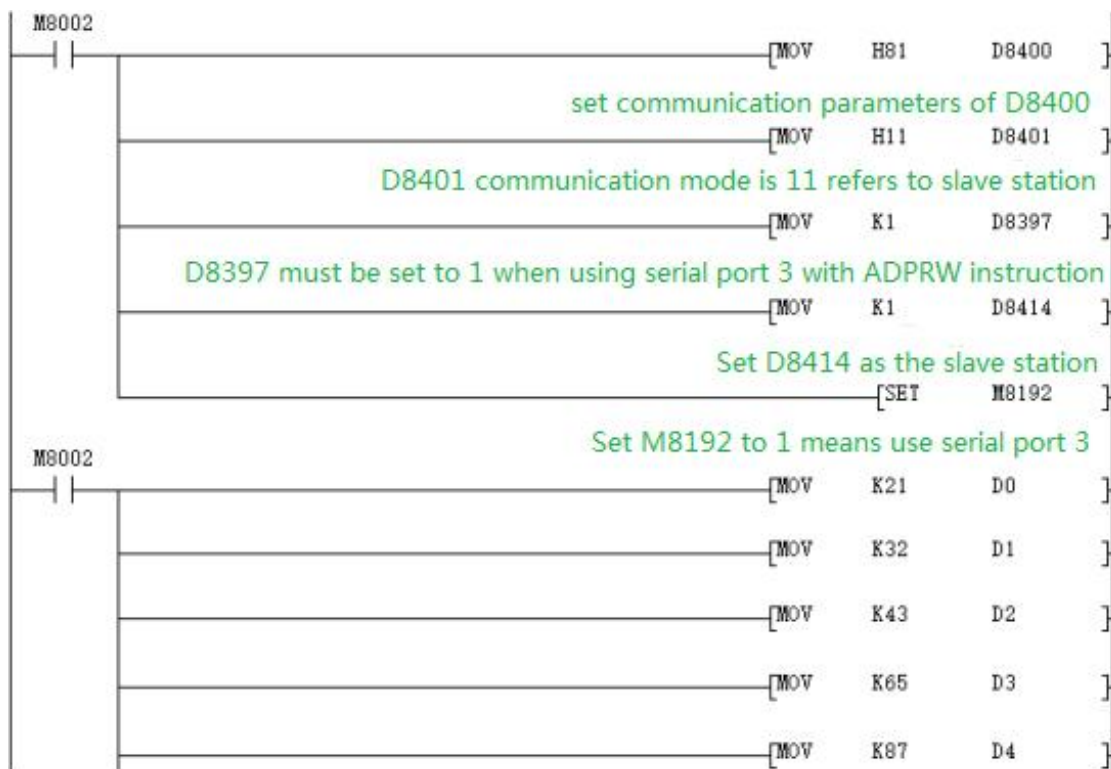

Use the serial port tool to monitor data of serial port 3 , and get the following results:

[2017:11:01:17:38:34][receive]01 04 00 00 00 06 70 08

[2017:11:01:17:38:34][receive]01 04 0C 00 15 00 20 00 2B 00 41 00 57 00  
00 5F A7

#### 8.4.5. Modbus ASCII function

When used as Modbus ASCII protocol: the specific parameter setting is the same as 8.4.3, only the 8th bit setting of D8401 is different, the introduction of specific setting D8401 parameter setting.

**Note: In modbus ASCII protocol, ADPRW command is not supported.**

**Demo program:**

Master program:

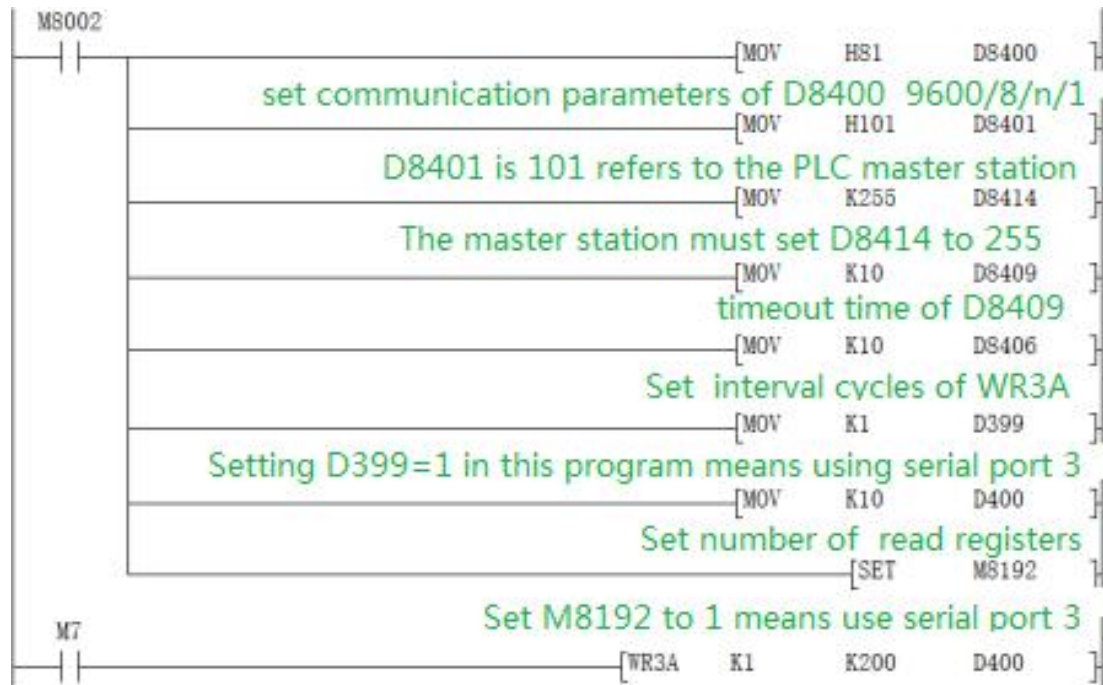

Slave program:

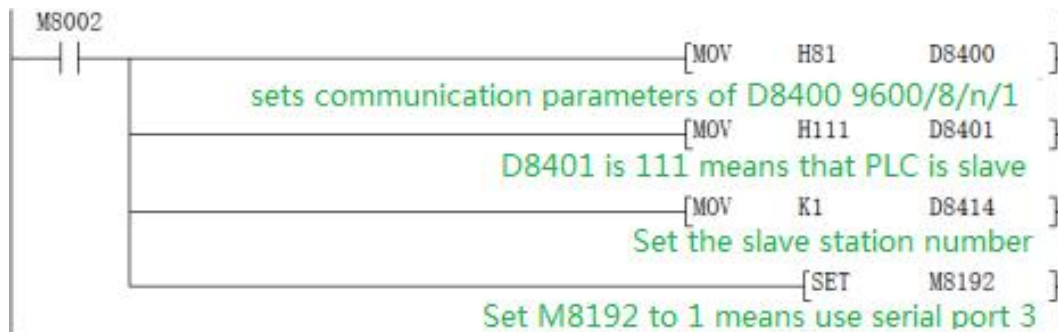

The data display status of slave D100~D109 before and after program execution is shown in the figure below.

	+F E D C	+B A 9 8	+7 6 5 4	+3 2 1 0	
D100	0 0 0 0	0 0 0 0	0 0 0 0	0 0 0 0	0
D101	0 0 0 0	0 0 0 0	0 0 0 0	0 0 0 0	0
D102	0 0 0 0	0 0 0 0	0 0 0 0	0 0 0 0	D100-D109 data
D103	0 0 0 0	0 0 0 0	0 0 0 0	0 0 0 0	before M7 is turned
D104	0 0 0 0	0 0 0 0	0 0 0 0	0 0 0 0	on
D105	0 0 0 0	0 0 0 0	0 0 0 0	0 0 0 0	
D106	0 0 0 0	0 0 0 0	0 0 0 0	0 0 0 0	
D107	0 0 0 0	0 0 0 0	0 0 0 0	0 0 0 0	
D108	0 0 0 0	0 0 0 0	0 0 0 0	0 0 0 0	
D109	0 0 0 0	0 0 0 0	0 0 0 0	0 0 0 0	
D110	0 0 0 0	0 0 0 0	0 0 0 0	0 0 0 0	

	+F E D C	+B A 9 8	+7 6 5 4	+3 2 1 0	
D100	0 0 0 0	0 0 0 0	0 0 0 0	1 0 1 1	11
D101	0 0 0 0	0 0 0 0	0 0 0 0	1 0 1 1	11
D102	0 0 0 0	0 0 0 0	0 0 0 0	1 0 1 1	11
D103	0 0 0 0	0 0 0 0	0 0 0 0	1 0 1 1	Data from D00-D109
D104	0 0 0 0	0 0 0 0	0 0 0 0	1 0 1 1	is written after M7 is
D105	0 0 0 0	0 0 0 0	0 0 0 0	1 0 1 1	turned on
D106	0 0 0 0	0 0 0 0	0 0 0 0	1 0 1 1	
D107	0 0 0 0	0 0 0 0	0 0 0 0	1 0 1 1	
D108	0 0 0 0	0 0 0 0	0 0 0 0	1 0 1 1	
D109	0 0 0 0	0 0 0 0	0 0 0 0	1 0 1 1	
D110	0 0 0 0	0 0 0 0	0 0 0 0	0 0 0 0	0

## 8.5. CAN Communication port

Support RS2 protocol and MODBUS RTU protocol. **Note:** After the CAN port setting is completed, the PLC must be disconnected (at least 15 seconds).

The special relays and special registers involved are as follows:

Function Description	Serial port 2(A/B)	Serial port 3(A1/B1)	CAN(H/L)	Remarks
Programming port	M8196=0	M8192=0	-	Non power retentive
RS/RS2 function	M8196=1 M8125=0	M8192=1	-	
RS/RS2 Send flag	M8122=1	M8402=1	M8422=1	Automatically reset at the end of sending
RS/RS2 Send complete flag	-	-	M8425	Need to reset manually
RS/RS2 Receive end flag	M8123	M8403	M8423	Need to reset manually
RS/RS2 Receiving process flag	M8124	M8404	M8424	Data is being received
RS/RS2 instruction 8-bit/16-bit distinguishing flag	M8161	M8161	M8161	
Master-slave flag when RS2 command CAN	-	-	M8426	M8426=0 master-slave mode, M8426=1 multi-machine mode
RS2 instruction last operand setting	-	1	2	
MODBUS function	M8196=1 M8125=1	M8192=1	-	
RD3A/WR3A receive correct flag	M8128	M8408	M8428	Automatic reset
RD3A/WR3A communication timeout flag	M8129	M8409	M8429	Automatic reset
ADPRW instruction completion flag	M8029	M8029	M8029	Instruction execution end flag
Communication parameters	D8120	D8400	D8420	
Communication mode	-	D8401	D8421	
Master and slave station number	D8121	D8414	D8434 D8440 D8442	D8434: Slave station number when CAN master-slave D8440\D8442 multi-machine mode ID number
RD3A/WR3A overtime time	D8129	D8409	D8429	The unit is milliseconds, see explanation for detailed settings
RD3A/WR3A Number of intervals	D8126	D8406	D8426	
RD3A/WR3A Last operand - 1	0	1	2	
ADPRW Set at command	D8397=0	D8397=1	D8397=2	
CAN Data Frame	-	-	M8427	

M8422:Send data, reset automatically at the end of sending

M8423:The data is received;

M8424:Data is being received;

M8425: After sending, it needs to be reset manually;

M8426: Multi-machine mode and master-slave mode switching

M8426=1: CAN is a multi-machine mode, there is no distinction between master and slave, and can transmit up to 8 bytes of data.

M8426=0: In CAN master-slave mode, there must be one master on the bus, which is similar in function to MODBUS.

M8427: =0 means set to CAN2.0B extended frame, =1 means set to CAN2.0A standard frame.

M8428: It turns ON when the MODBUS communication response is correct, and it needs to be reset manually.

M8429: Communication timed out.

D8420: Communication parameters.

The 0th~9th bits of D8420 are CAN baud rate, 1K~1023K. The default is 500.

Supported baud rate: 5 10 15 20 25 40 50 62 80 100 125 200 250  
400 500 666 800 1000

D8421: Communication protocol and description of master and slave stations;

For RS2 instruction: D8421=H10 should be set, which means free agreement.

For RD3A, WR3A, and ADPRW : D8421=H1 means master station, D8421=H11 means slave station.

D8397: When using CAN in ADPRW instruction, D8397 must be set to 2.

D8426: Number of interval cycles, default=12 (times);

D8429: Timeout time, (unit: milliseconds, recommended setting: when the communication rate setting is greater than or equal to 9600, D8429 is set to 10~20; when the communication rate setting is less than 9600, D8429 is set to 20~50; when using RD3A and WR3A, the master station timeout time is set to about 6 longer than the slave station timeout time).

D8434: Slave station number

D8440: Save the ID number of the machine (slave station number).

D8442: When multi-channel interconnection, save the slave station ID number (which slave station sent the data read, the ID of the slave station).

#### **D8421 Communication parameter format setting**

b0	Choose agreement	0:Other communication protocols	1:MODBUS protocol
b1~b3	Not available, set to 0		
b4	Master/slave settings	0:MODBUS master station	1:MODBUS slave station
b5~b7	Not available, set to 0		
b8	RTU/ASCII Mode setting	0:RTU	1:ASCII
b9~b15	Not available, set to 0		

#### **8.5.1. Freepoint protocol function**

When the RS2 command is used, multiple channels can be interconnected, and the communication PLC can be distinguished by ID number. D8440 saves the ID number of the machine, D8442 saves the ID number of the PLC where the data read in; the ID number uses a 32-bit register, but the setting can only use 29 bits, that is, the upper 3 bits have no effect. When the RS2 command is used, up to 8 lengths of data can be sent.

Program example:

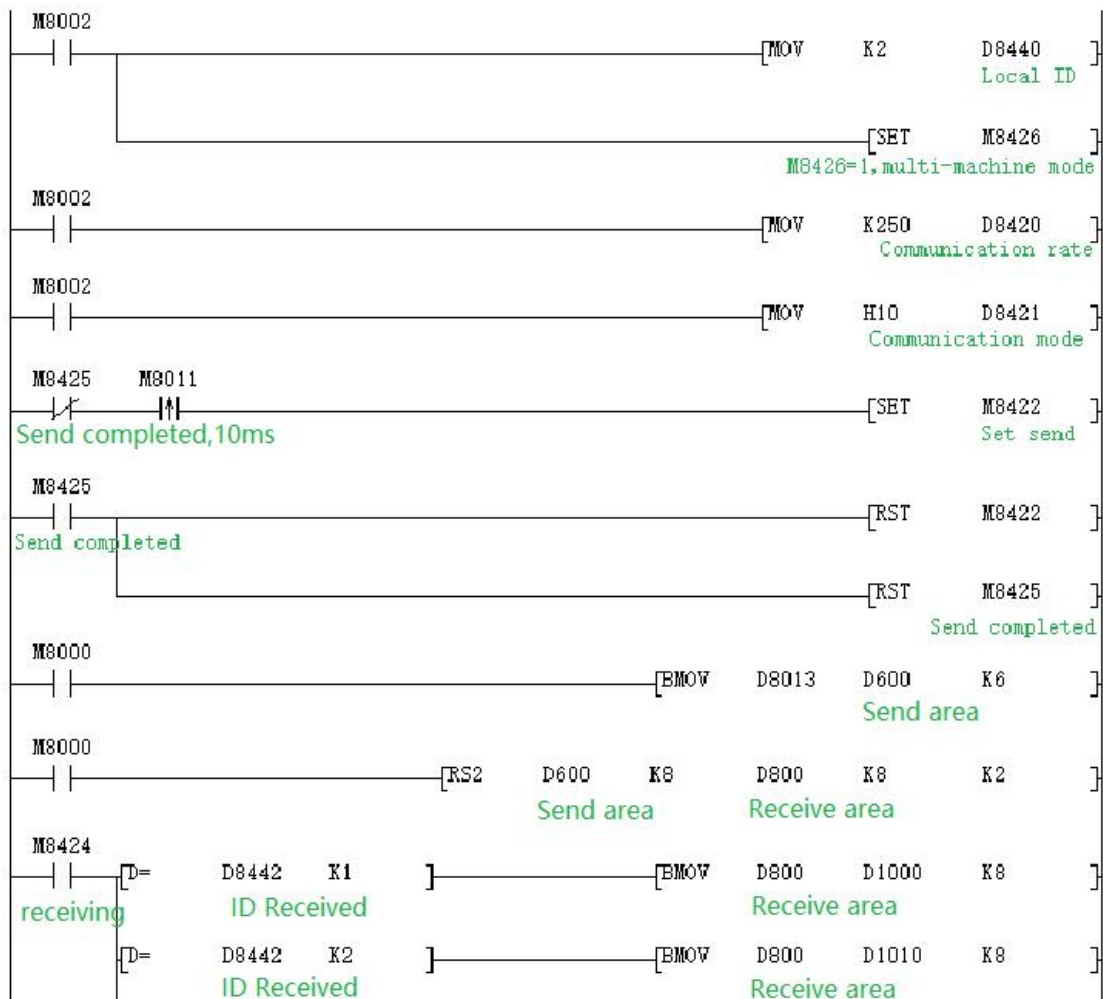

RS2 command last parameter=1: Serial port 3;

=2: CAN.

### 8.5.2. Modbus RTU function RD3A/WR3A instruction

RD3A program example (refer to [chapter 8.1.1](#) )

Master program:

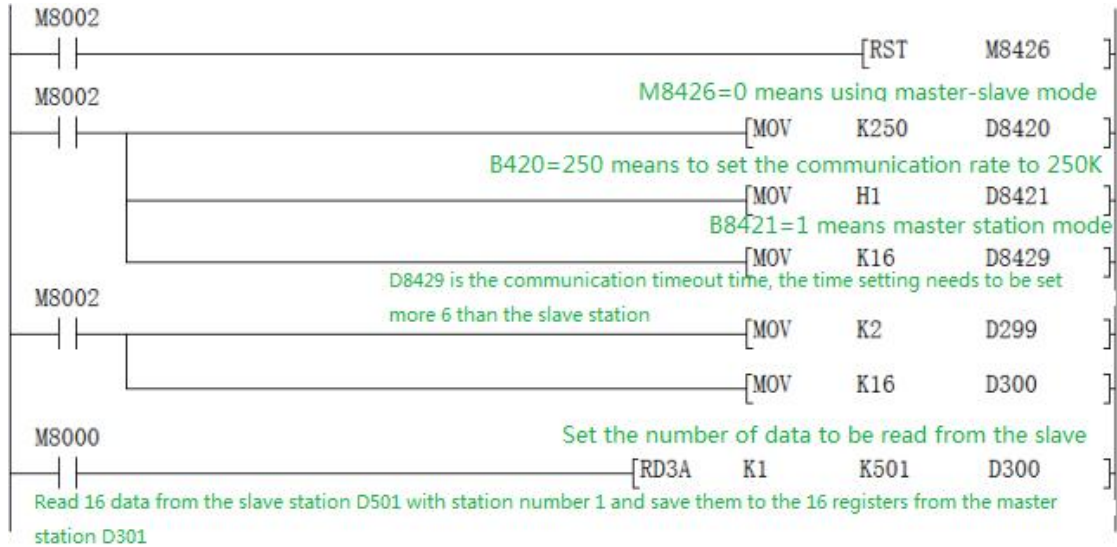

### Slave program

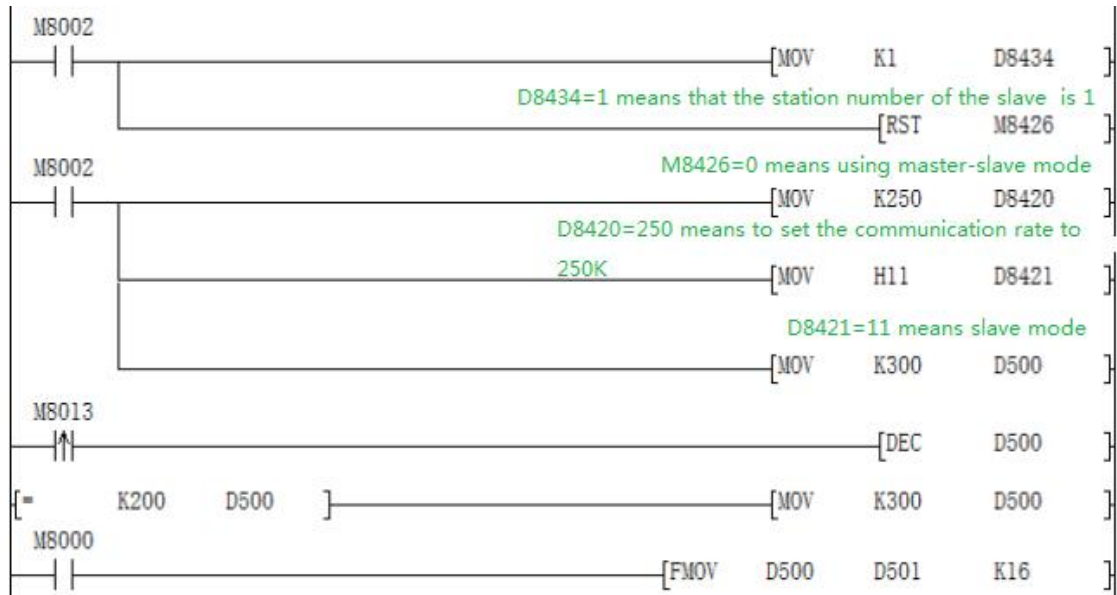

Monitoring the master station program, the master station D301-D316 has a total of 16 data at the speed of subtracting 1 per second and changing between 300-200.

**WR3A program example (refers to [chapter 8.1.1](#) for instruction introduction):**

Master program:

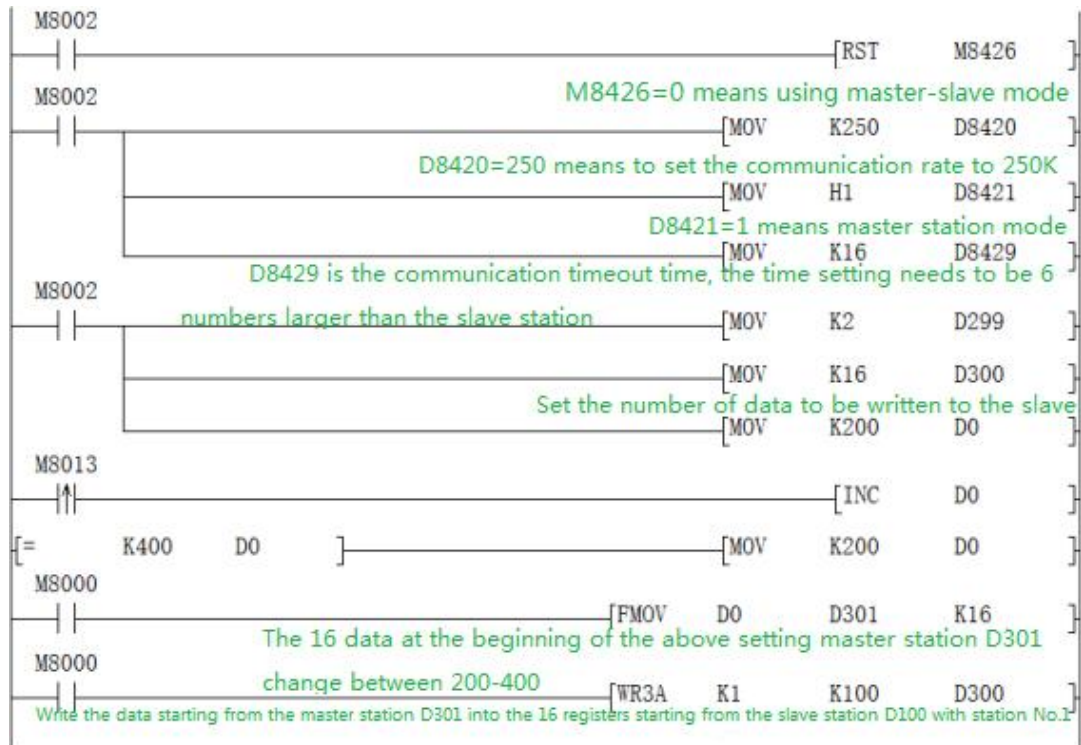

Slave program:

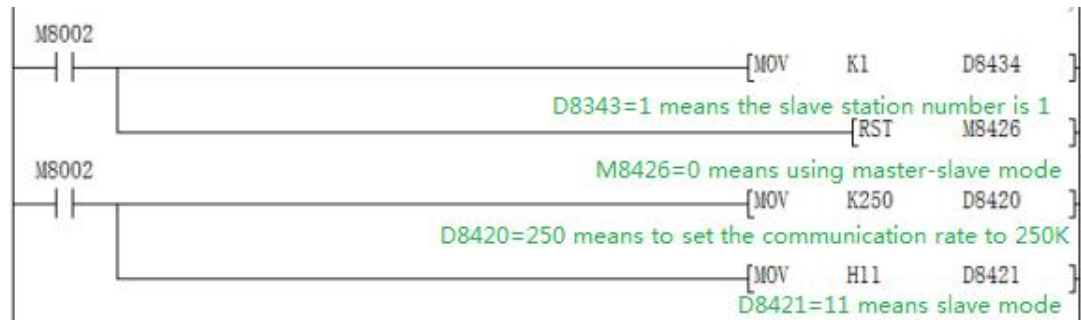

Monitoring the program of the slave station, a total of 16 data from the stations D100-D115 can be changed between 200-400 at the speed of adding 1 per second.

### 8.5.3. Modbus RTU function ADPRW instruction

01 Input register readout program example (refer to [chapter 8.1.2](#) for instruction introduction)

Master Program

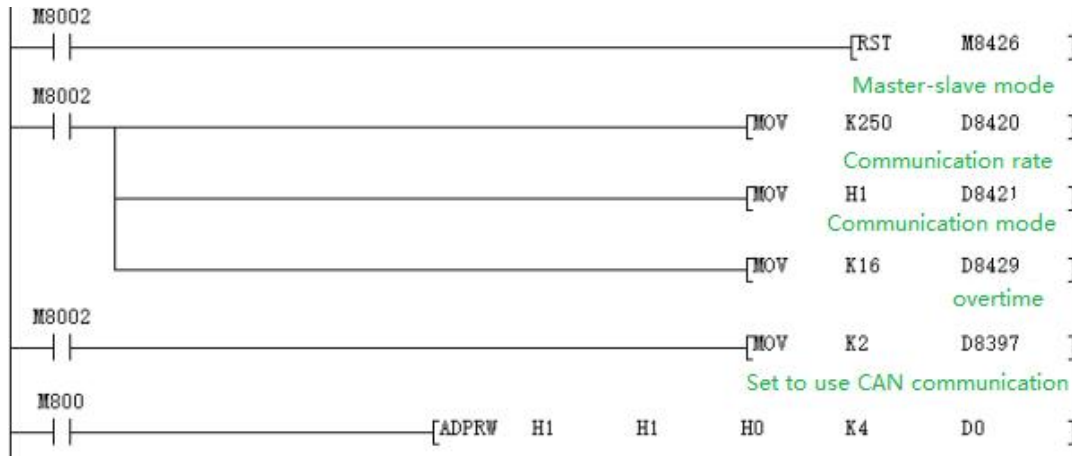

### Slave program

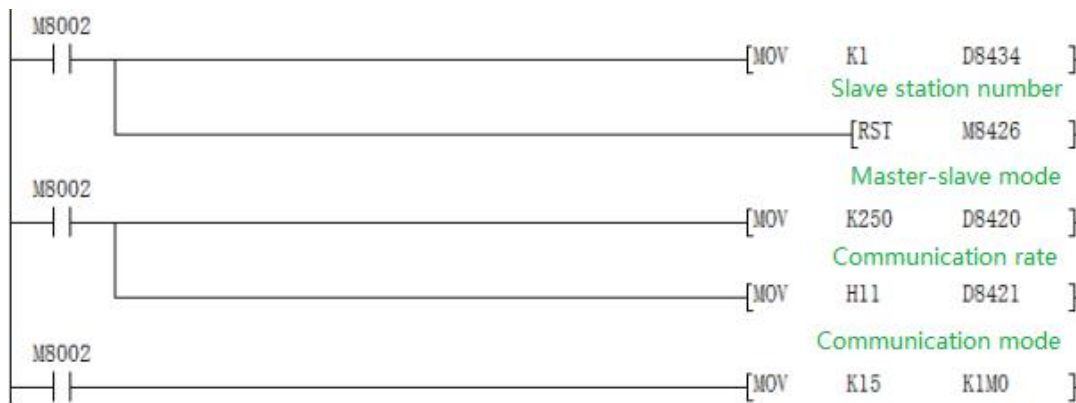

It means to communicate with the CAN port of the slave PLC through the CAN port of this PLC, and read the 4-bit M0~M3 of the slave PLC to D0 of the master PLC.

## 8.6. Network communication

Support Mitsubishi MC protocol, modbus TCP/UDP protocol and EtherNet/IP protocol.

The network is automatically detected after power-on. When there is a network chip, M8193=1, the network is ready.

The involved special relays, special registers, and registers used by the IP address are as follows:

Function Description	Network usage	remarks
Network preparation	M8193	
Connection communication flag	M8395	=1: Communication is normal =0: The connection communication is abnormal; Change from normal to abnormal, automatically reconnect once
Write network address	M8197	
MODBUS timeout	M8062	
IP address conflict	M8063	
Obtain the current IP address automatically	M8324	26238 and above versions use
EtherNet/IP and MODBUS master, the number of slaves	D8325	$1 \leq D8325 \leq 4$
EtherNet/IP and MODBUS switch sign	D8395	
Set during ADPRW instruction	D8397=3	
Router address	R23800 R23801	
Mask address	R23802 R23803	
MAC address	R23804~R23806	
Local IP address	R23807 R23808	
Destination IP address	R23830 R23831(Server 1) R23840 R23841(Server 2) R23850 R23851(Server 3) R23860 R23861(Server 4)	
port	R23812	Default 502
RD3A/WR3A instruction cycle times	R23813	
MODBUS timeout	R23814	
Number of packets sent	R23815	
Number of received packets	R23816	
overtime time	R23824	Default 200ms

M8193: =1 Indicates that there is a network chip, and the network is ready

M8197: =1 Write the network address and reset automatically.

M8062: =1 Indicates MODBUS timeout, MODBUS\_TCP is used.

M8063: =1 Indicates an IP address conflict.

D8325: The number of slave stations, the number of connections must be set when acting as the master,  $1 \leq D8325 \leq 4$ , the default is  $D8325=0$ .

D8395: EtherNet/IP and MODBUS\_TCP switch;

D8395=0: EtherNet/IP master station (with 4 slave stations at most)

D8395=1: MODBUS\_UDP Slaves

D8395=2: MODBUS\_UDP Masters

D8395=3: MODBUS\_TCP Slaves (Server)

D8395=4: MODBUS\_TCP Masters (Client, with up to 4 slaves)

D8395=5: EtherNet/IP Slaves (Server)

Note: In the local area network, MODBUS TCP or Ethernet/IP communication can be used, and Mitsubishi programming software can be used to program through the network port.

D8397: When using MODBUS\_TCP for ADPRW instruction, D8397 needs to be set to 3.

R23800 and 23801 are router addresses. The default is 192.168.1.1. That is, R23800=0XC0A8, R23801=0X0101.

R23802 and 23803 are the mask addresses, and the default is 0 .0. 0 .0. That is, R23802=0, R23803=0.

R23804~23806 are MAC addresses, which are generated by the system and are basically not repeated. Can also be set. **Note: The MAC address on the same network cannot be repeated, otherwise it will cause abnormal communication.**

R23807 and R23808 are the IP addresses of this machine. The default is 192.168. 1.250, that is, R23807=0XC0A8, R23808=0X01FA.

R23830, R23831/R23840, R23841/R23850, R23851/R23860, R23861 are MODBUS target IP.

R23812 port default 502

R23813 default=100 (number of cycles), which is the interval time between WR3A and RD3A sequence execution.

R23814 default = 20 (200ms), it is the MODBUS timeout time setting, only

retry twice, each time = (R23814\*5)ms.

R23815 is the number of MODBUS sent packets

R23816 is the number of MODBUS received packets.

### 8.6.1. MITSUBISHI MC protocol

Note: a. MC protocol and cloud configuration background can coexist, even when MC protocol is used, it can also be connected with Coolamy Cloud background.

b. When the MC protocol is used, the default port is 5556.

c. When the communication is unsuccessful, check whether the IP of the PLC and HMI is correct (ensure the same network segment), whether the IP of the HMI remote access is correct, whether the HMI protocol is selected correctly, and whether the network cable is connected correctly.

#### 1. Set the IP address of the PLC

a. Automatic acquisition: M8324 is set when M8002 is powered on



b. Manual settings:

Method 1:

Write directly to the IP register

Router address: R23800 R23801; default 192.168.1.1. That is,  
R23800=0XC0A8, R23801=0X0101.

Subnet mask: R23802 R23803; default 0 .0. 0 .0. That is, R23802=0,  
R23803=0.

IP address: R23807 R23808; the default is 192.168.1.250, that is,  
R23807=0XC0A8, R23808=0X01FA.

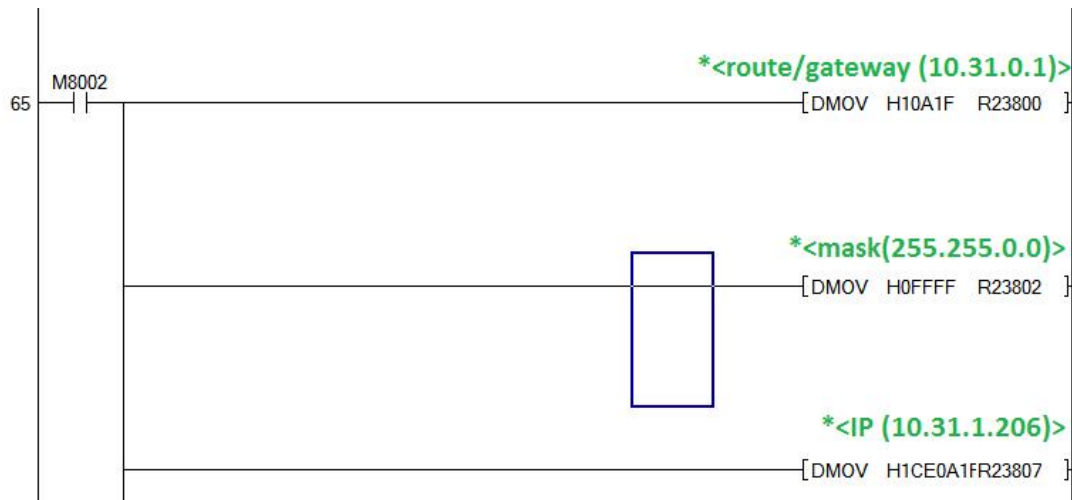

Method 2:

Use cloud parameter setting software (Cloudset.exe) to set

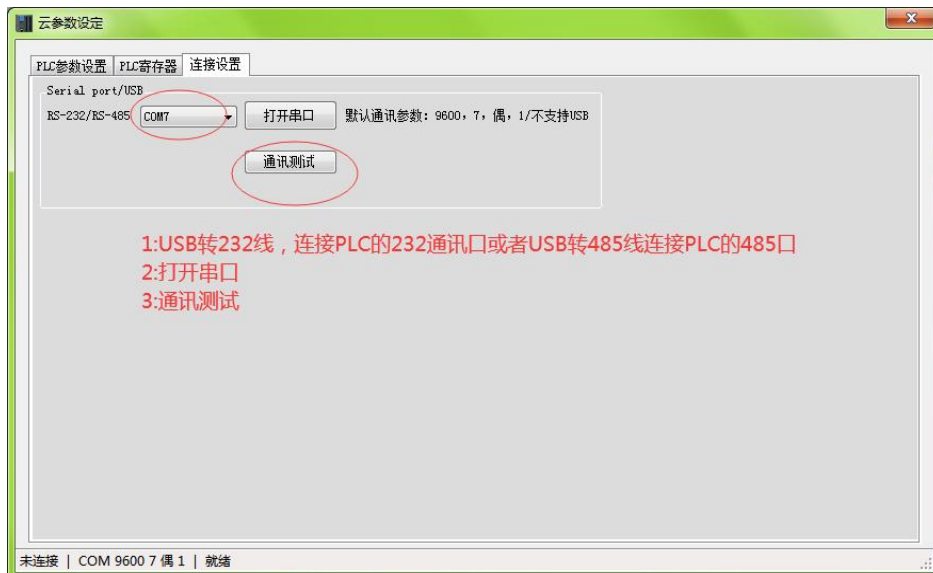



## 2. Diagram of network connection

### a. Without switching equipment

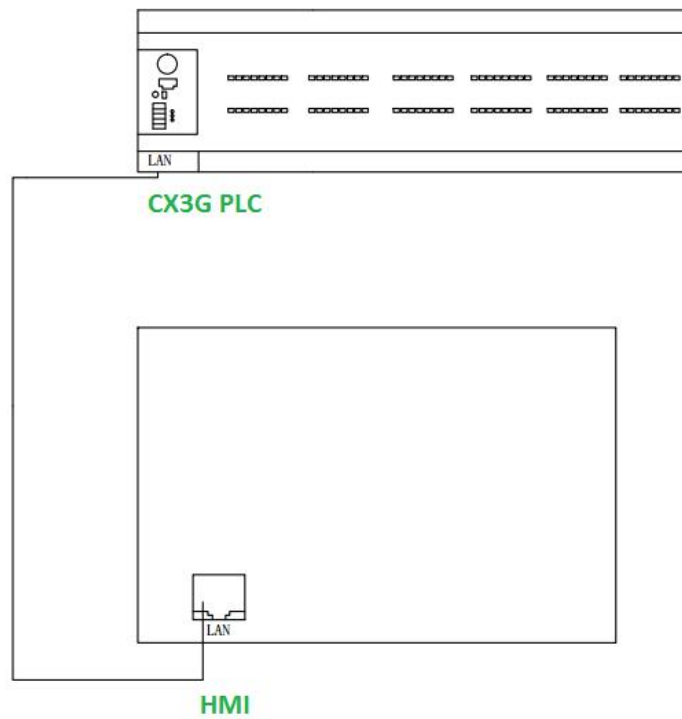

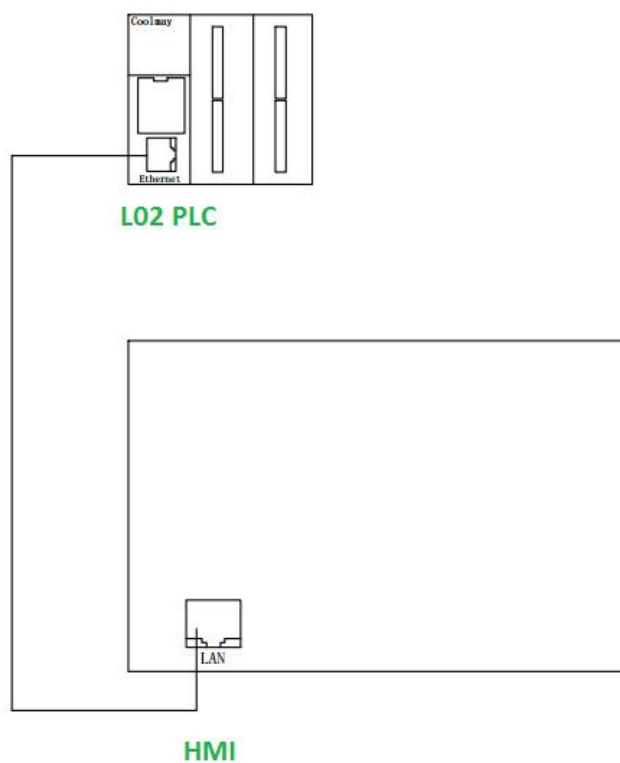

b. Through the switching equipment

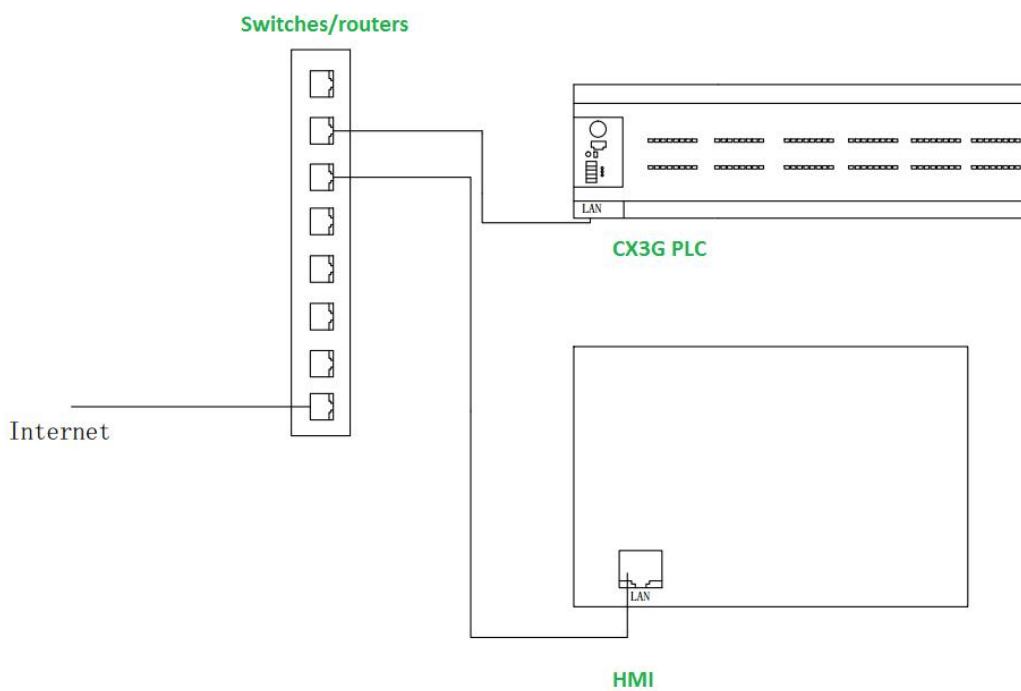

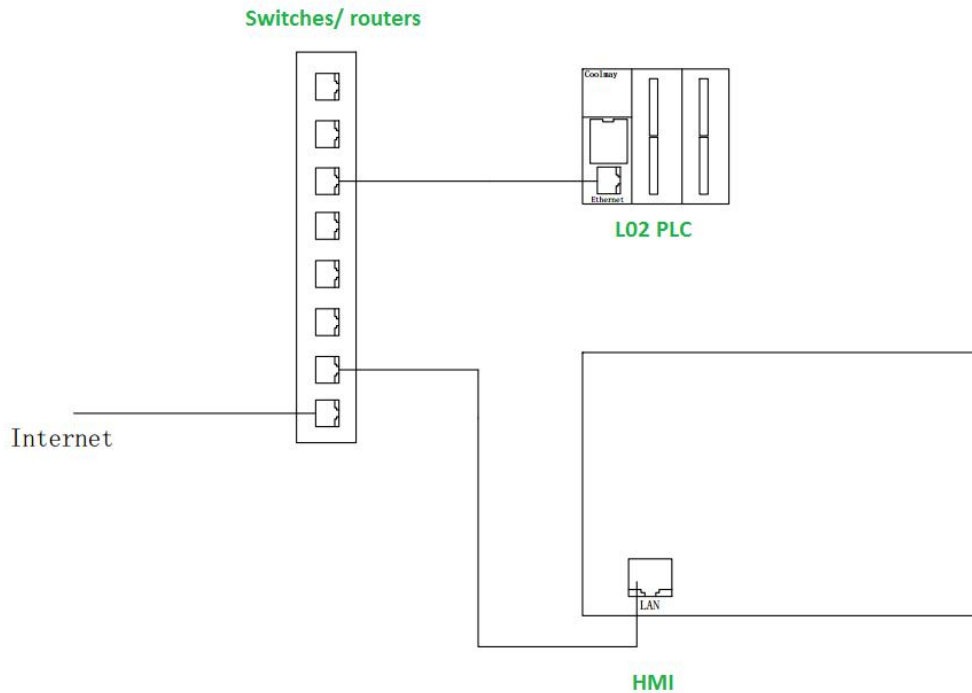

### 3. HMI settings (different manufacturers have different HMI settings)

#### a. Weilun HMI protocol settings:

**Device Settings** ✕

Name :

HMI  Device

Location :

\* Select Local for a device connected to this HMI, or Remote for a device connected through another HMI.

Device type :

Device ID : 105, V. 1. 10, MITSUBISHI\_FX3U\_ETHERNET.e30

I/F :

\* Support off-line simulation on HMI (use LB-12358).

IP :

Use UDP (User Datagram Protocol)

Interval of block pack (words) :

Max. read-command size (words) :

Max. write-command size (words) :

The settings in the above figure indicate that the HMI accesses the PLC whose IP is 10.31.1.223, and the port is 5556.

### 8.6.2. Modbus TCP Function

The master station supports WR3A RD3A instructions, WR3A D300 D400 D500, RD3A D300 D400 D500, and requires D499=3

When D499=0, it is serial port 2 MODBUS.

When D499=1, it is serial port 3 MODBUS.

When D499=2, it is CAN\_MODBUS.

When D499=3, it is network MODBUS.

Slave station response function code, does not support five kinds of 0X7 0X8 0XB 0XC 0X11, others are supported

**RD3A program example (refer to [chapter 8.1.1](#) for instruction introduction):**

Master Program:

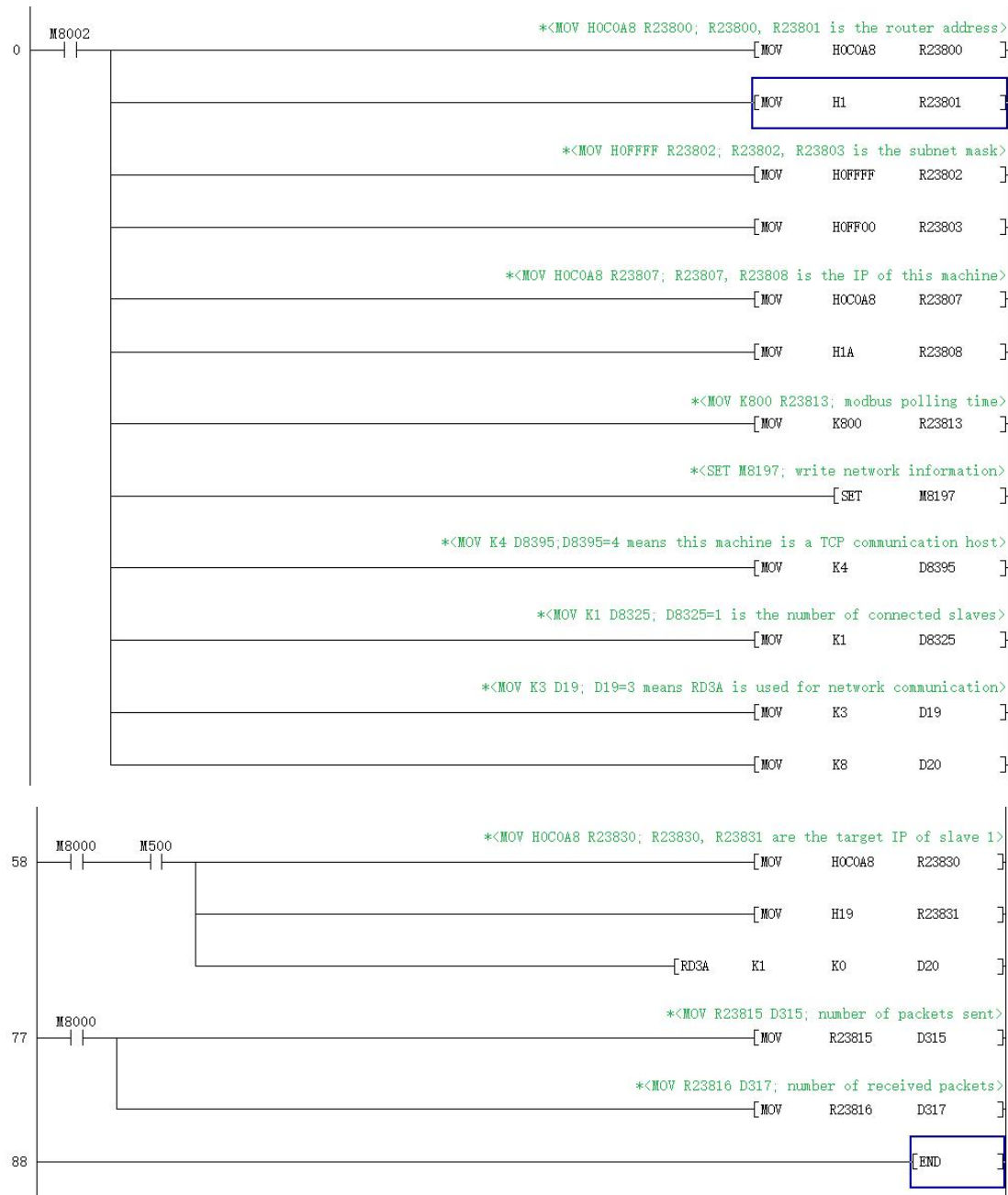

Slave program:



### 8.6.3. Ethernet/IP function

#### 8.6.2.1 Communication with L02-EIP

When the L02 series host computer and L02-EIP module use the Ethernet/IP protocol to communicate, the L02-EIP module is used as the slave station, and the DIP switch needs to be used to set the slave station IP address on the L02-EIP. And if the analog input expansion module is connected to the L02-EIP, you need to set the analog input type of each channel of LO2-EIP. For detailed setting method, please refer to "Coolmay L02-EIP Module User Manual"

#### 8.6.2.2 L02 PLC as Ethernet/IP master station

The following special registers need to be set when the L02 master is the master.

D8325: The number of EtherNet/IP slave stations. Currently, it supports a maximum of 4 slave stations.

D8395: EtherNet/IP and MODBUS switch flag, default D8395=0;

R23824: The timeout period is 200ms by default.

R23820-R23823 are EIP connection status:

=1 means connecting

=0 not connected

=2 successfully connected

=345 is the EIP handshake process

=5 the handshake is successful

R23834, R23844, R23854, R23864 set the number of bytes input by switch;

R23835, R23845, R23855, R23865 set the number of analog input words;

R23836, R23846, R23856, R23866 set the switch to measure the number of bytes;

R23837, R23847, R23857, R23867 set the number of analog output words;

The number of digital bytes must be set to an even number. For example, if the number of digital input bytes in the slave is 3, then the number of digital bytes in the master must be set to 4, otherwise the data will be messy. After setting, set M8197 once to start communication.

### 1. PLC as Ethernet/IP master station

The host will automatically map the data of the slave to the corresponding internal address, and the mapping relationship is as follows:

Number of slaves D8325	Slave IP	Number of digital input bytes	200 host corresponding addresses	Number of analog input words	50 host corresponding addresses	digital output bytes	200 host corresponding addresses	Number of analog output words	50 host corresponding addresses	Connection Status
Slave 1	R23830 R23831	R23834	M5000- M5199	R23835	R23100- R23149	R23836	M6000- M6199	R23837	R23300- R23349	R23820
Slave 2	R23840 R23841	R23844	M5200- M5399	R23845	R23150- R23199	R23846	M6200- M6399	R23847	R23350- R23399	R23821

Slave 3	R23850 R23851	R23854	M5400- M5599	R23855	R23200- R23249	R23856	M6400- M6599	R23857	R23400- R23449	R23822
Slave 4	R23860 R23861	R23864	M5600- M5799	R23865	R23250- R23299	R23866	M6600- M6799	R23867	R23450- R23499	R23823

Slave input allocation (D2000-D2199) 200 bytes

Slave output allocation (D1000-D1199) 200 bytes

#### The first slave address allocation:

- 1) Digital input: 24 bytes (M5000-M5191)

Slave station address allocation: D2000-D2023

- 2) Analog input: 50 words (100 bytes) (R23100-R23149)

Slave station address allocation: D2024-D2123

- 1) Digital output: 24 bytes (M6000-M6191)

Slave station address allocation: D1000-D1023

- 2) Analog output: 50 words (100 bytes) (R23300-R23349)

Slave station address allocation: D1024-D1123

#### The second slave address allocation:

- 1) Digital input: 24 bytes (M5200-M5391)

Slave station address allocation: D2000-D2023

- 2) Analog input: 50 words (100 bytes) (R23150-R23199)

Slave station address allocation: D2024-D2123

- 1) Digital output: 24 bytes (M6200-M6391)

Slave station address allocation: D1000-D1023

- 2) Analog output: 50 words (100 bytes) (R23350-R23399)  
Slave station address allocation: D1024-D1123

**The third slave address allocation:**

- 1) Digital input: 24 bytes (M5400-M5591)  
Slave station address allocation: D2000-D2023
- 2) Analog input: 50 words (100 bytes) (R23200-R23249)  
Slave station address allocation: D2024-D2123
  
- 1) Digital output: 24 bytes (M6400-M6591)  
Slave station address allocation: D1000-D1023
- 2) Analog output: 50 words (100 bytes) (R23400-R23449)  
Slave station address allocation: D1024-D1123

**The fourth slave address allocation:**

- 1) Digital input: 24 bytes (M5600-M5791)  
Slave station address allocation: D2000-D2023
- 2) Analog input: 50 words (100 bytes) (R23250-R23299)  
Slave station address allocation: D2024-D2123
  
- 1) Digital output: 24 bytes (M6600-M6791)  
Slave station address allocation: D1000-D1023
- 2) Analog output: 50 words (100 bytes) (R23450-R23499)  
Slave station address allocation: D1024-D1123

**2. Ethernet/IP Host program example:**



### 8.6.2.3 L02 PLC as Ethernet/IP slave

When the L02 host PLC is used as a slave station for Ethernet/IP protocol communication, it needs to be set as follows:

M8197: =1 to write the network address and automatically reset.

D8395: EtherNet/IP slave (server)

Transfer the data that needs to be read or written in the program to a fixed corresponding register interval, the relationship is as follows:

	Input register fixed correspondence (the lower eight bits are valid)	Output register fixed correspondence (the lower eight bits are valid)
slave	D2000-D2199	D1000-D1199

The Ethernet/IP host only needs to configure the corresponding input and output connection address, and it will automatically map the data of the slave to the configured connection address.

**Example of L02 PLC as Ethernet/IP slave station program:**

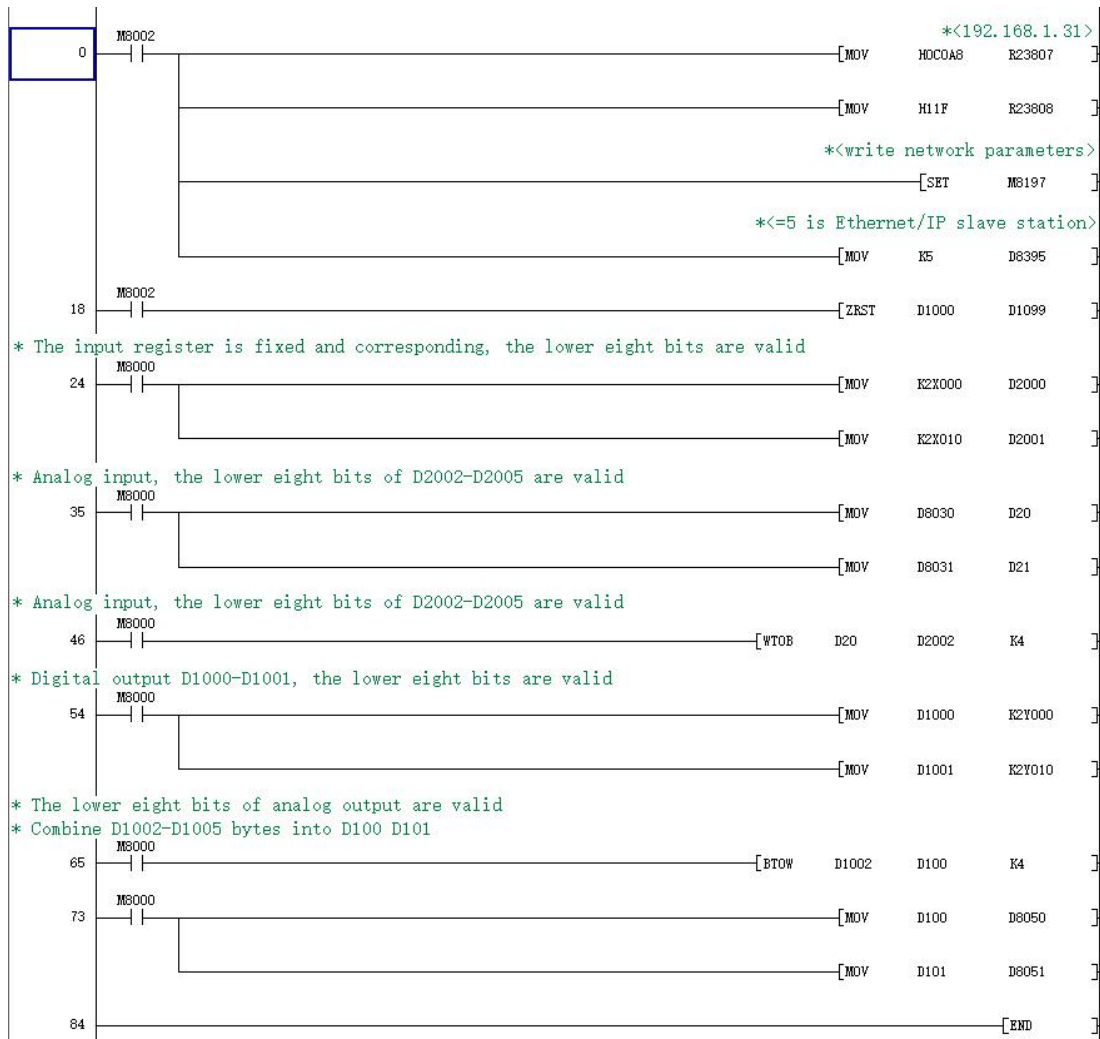

#### 8.6.2.4 L02 series Ethernet/IP protocol use structure diagram

1. The L02 host is the master station of the Ethernet/IP protocol, and L02-EIP is the slave station of the Ethernet/IP protocol, passing through the router.

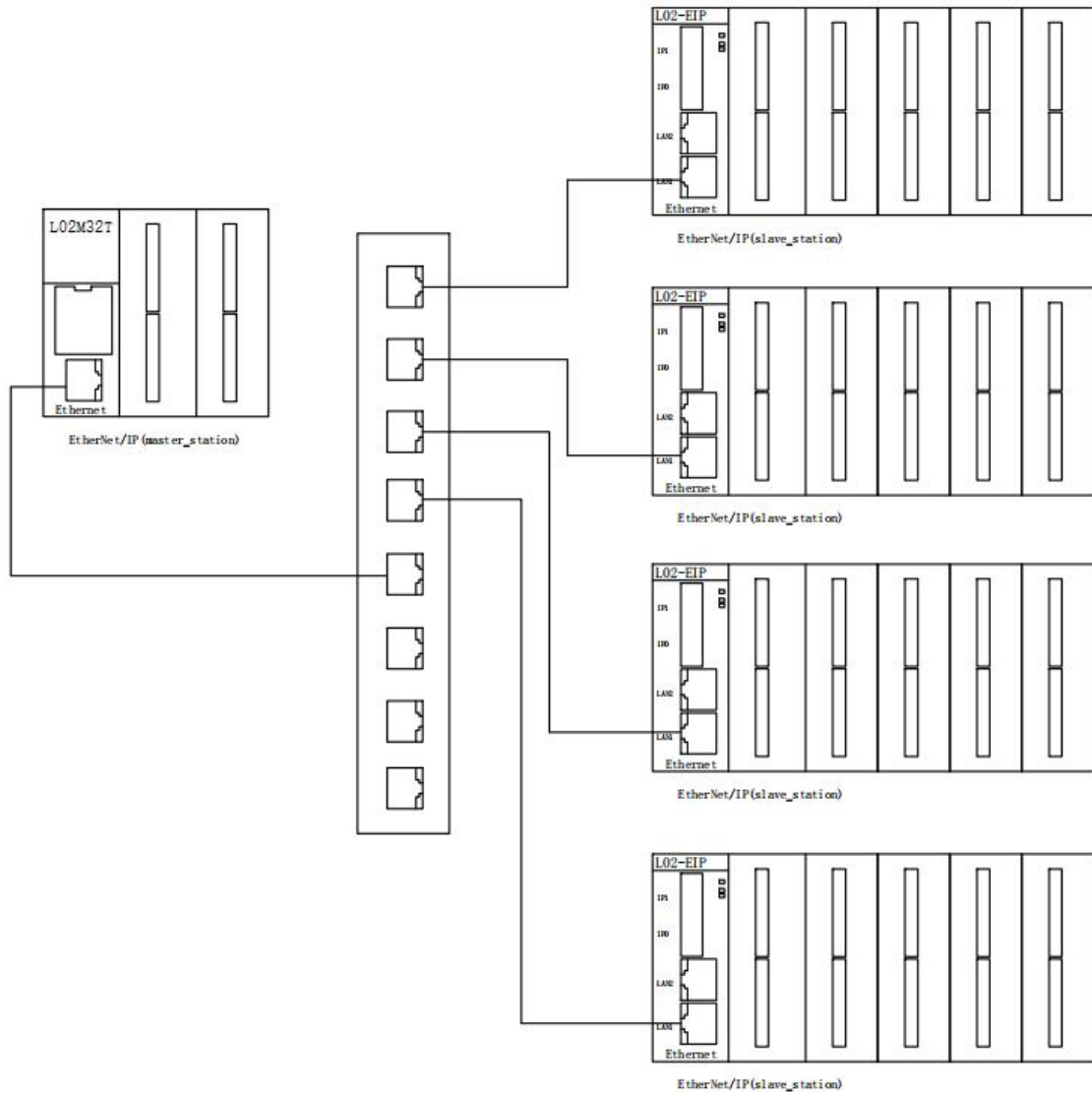

2. The L02 host is the master station of the Ethernet/IP protocol, and the L02-EIP is the slave station of the Ethernet/IP protocol, without going through the router.

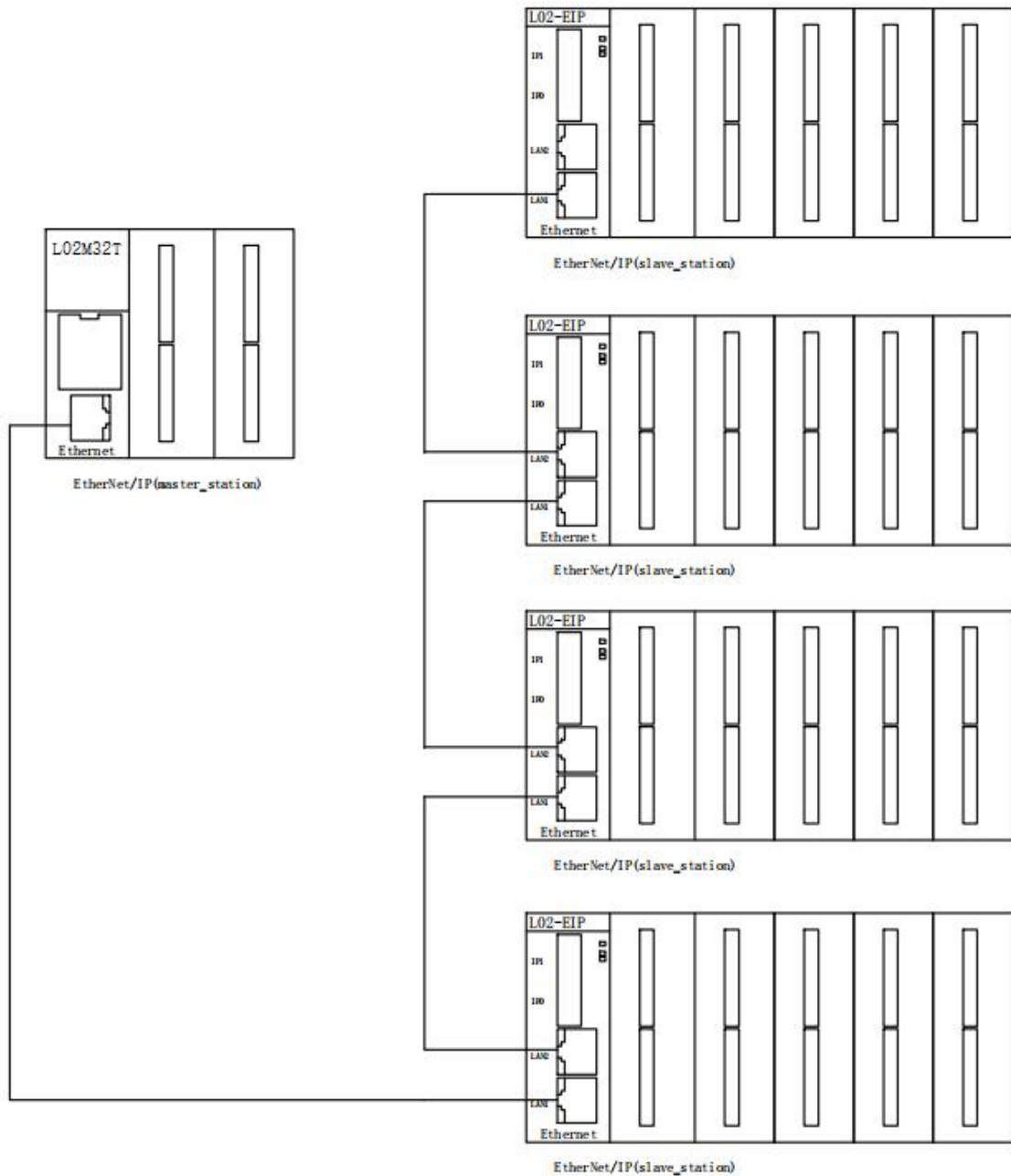

3. The L02 host is the master station of the Ethernet/IP protocol, and the L02 host is the slave station of the Ethernet/IP protocol.

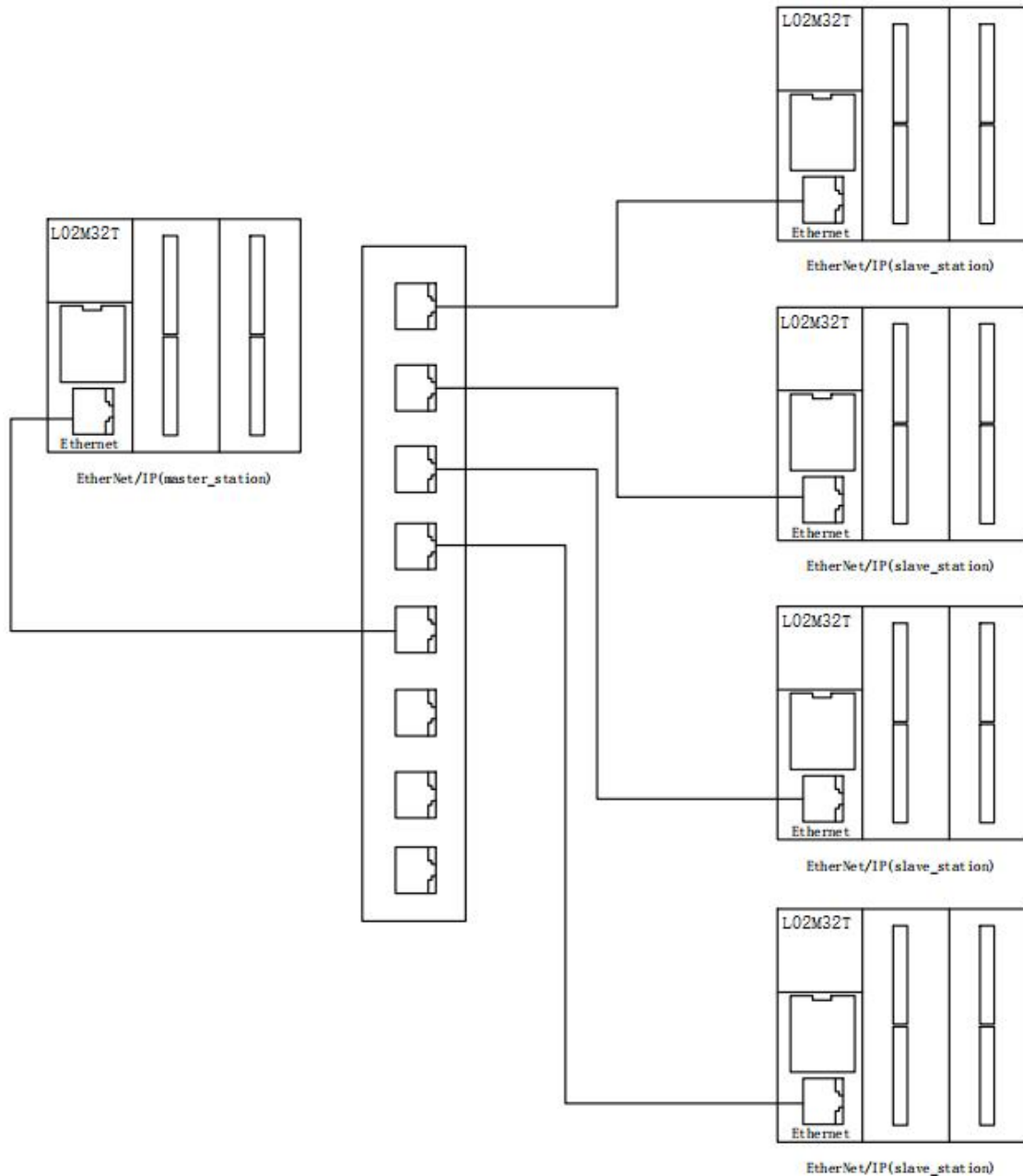

4. The L02 host is the master station of the Ethernet/IP protocol, and the L02 host and the L02-EIP module are mixed as the slave station of the Ethernet/IP protocol

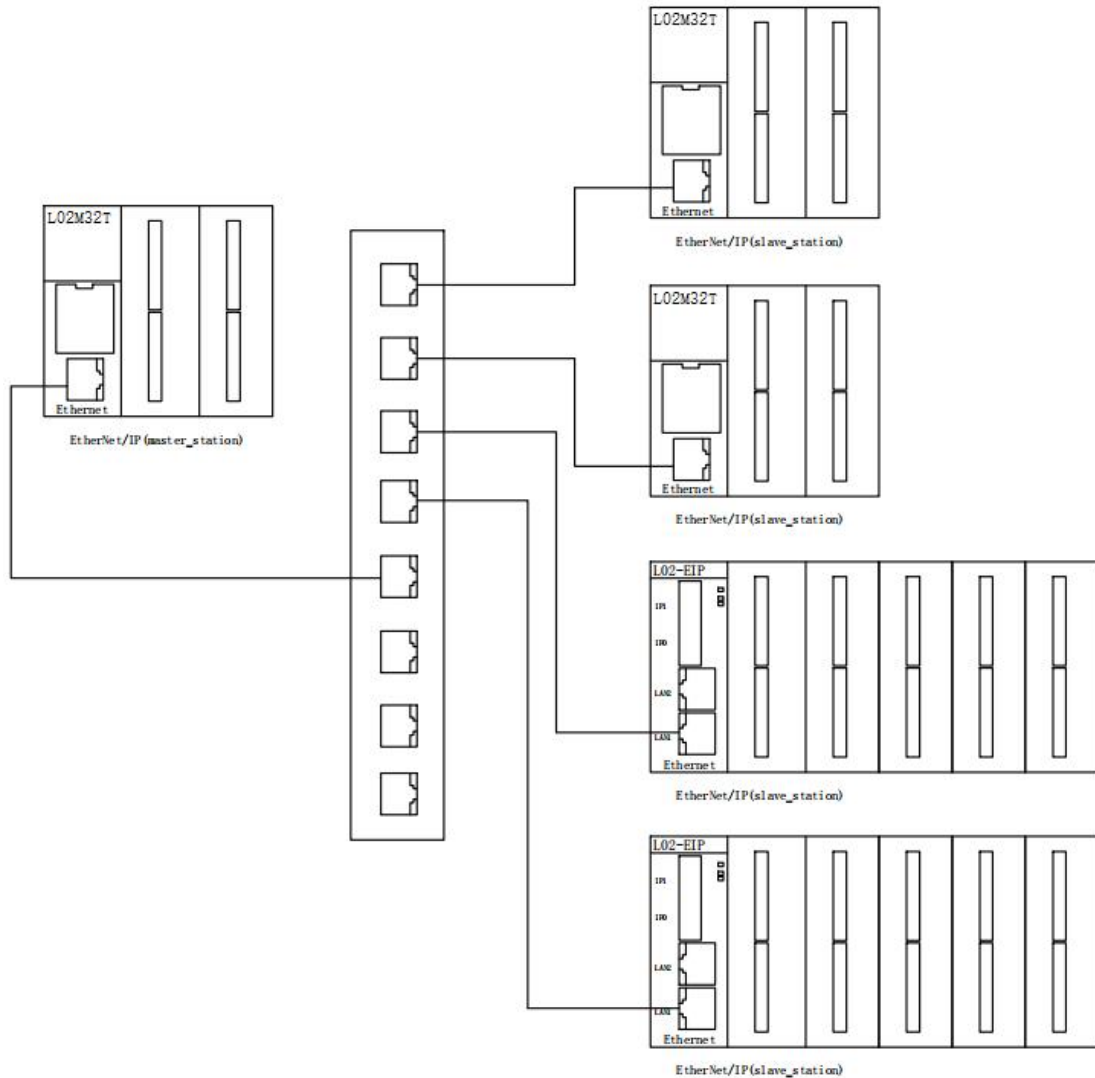

## 8.7. Network N:N communication

### 8.7.1. Related device content

#### 1. N:N Device for network setting

Device	Name	Content	Set value
M8038	Parameter setting	Set the flag bit for communication parameters. It can also be used as a flag bit for confirming whether there is an N:N network program. Do not turn ON in the sequence program.	
D8176	Setting of the corresponding station number	N:N network setting when using the station number. The master station is set to 0, and the slave station is set to 1-15. [Initial value: 0]	0~15
D8177	Total number of slaves setting	Set the total number of slave stations. No setting is required in the programmable controller of the slave station. [Initial value: 7]	1~15

D8178	Refresh Range setting	Select the mode of the number of device points to communicate with each other. No setting is required in the programmable controller of the slave station. [Initial value: 0]	0~2
D8394	Serial channel selection	=2: Serial port2 =3: Serial port3 =4: CAN	2~4

## 2. Components for judging N:N network errors

M8184~M8190, M8496~M8503: Data transmission sequence error flag of the slave.

When each slave station has a data transmission sequence error, the corresponding flag bit is ON.

Station No.	1	2	3	4	5	6	7	8	9	10	11	12	13	14	15
Relay	M8184	M8185	M8186	M8187	M8188	M8189	M8190	M8496	M8497	M8498	M8499	M8500	M8501	M8502	M8503

## 3. Link device

It is a device used to send and receive information between each programmable controller. Depending on the station number set in the corresponding station number setting and the mode set in the refresh range setting, the device numbers and points used are also different.

### 1) In mode 0 (D8178=0):

Station No.	Station 0	Station 1	Station 2	Station 3	Station 4	Station 5	Station 6	Station 7
Word device (4 points each)	D0~D3	D10~D13	D20~D23	D30~D33	D40~D43	D50~D53	D60~D63	D70~D73
Station No.	Station 8	Station 9	Station 10	Station 11	Station 12	Station 13	Station 14	Station 15
Bit device (4 points each)	D80~D83	D90~D93	D100~D103	D110~D113	D120~D123	D130~D133	D140~D143	D150~D153

## 2) In mode 1 (D8178=1)

Station No.	Station 0	Station 1	Station 2	Station 3	Station 4	Station 5	Station 6	Station 7
Word device (32 points each)	M1000~ M1031	M1064~ M1095	M1128~ M1159	M1192~ M1223	M1256~ M1287	M1320~ M1351	M1384~ M1415	M1448~ M1479
Bit device (4 points each)	D0~D3	D10~ D13	D20~ D23	D30~ D33	D40~ D43	D50~ D53	D60~ D63	D70~ D73
Station No.	Station 8	Station 9	Station 10	Station 11	Station 12	Station 13	Station 14	Station 15
Bit devices (32 points each)	M1512~ M1543	M1576~ M1607	M1640~ M1671	M1704~ M1735	M1768~ M1799	M1832~ M1863	M1896~ M1927	M1960~ M1991
Word device (4 points each)	D80~ D83	D90~ D93	D100~ D103	D110~ D113	D120~ D123	D130~ D133	D140~ D143	D150~ D153

## 3) In mode 2 (D8178=2):

Station No.	Station 0	Station 1	Station 2	Station 3	Station 4	Station 5	Station 6	Station 7
Bit devices (64 points each)	M1000~ M1063	M1064~ M1127	M1128~ M1191	M1192~ M1255	M1256~ M1319	M1320~ M1383	M1384~ M1447	M1448~ M1511
Word device (8 points each)	D0~D7	D10~ D17	D20~ D27	D30~ D37	D40~ D47	D50~ D57	D60~ D67	D70~ D77
Station No.	Station 8	Station 9	Station 10	Station 11	Station 12	Station 13	Station 14	Station 15
Bit devices (64 points each)	M1512~ M1575	M1576~ M1639	M1640~ M1703	M1704~ M1767	M1768~ M1831	M1832~ M1895	M1896~ M1959	M1960~ M2023
Word device (8 points each)	D80~ D87	D90~ D97	D100~ D107	D110~ D117	D120~ D127	D130~ D137	D140~ D147	D150~ D157

### 8.7.2. Program settings and instructions

The program settings are as follows. The timeout waiting register D8129/D8409/D8429 is recommended to be set to 12 or more. You only need to set the corresponding special register to realize the data sharing of the corresponding interval register and auxiliary relay. There is no need to write read and write instructions. Channel M8184~M8190 and the last 8 channels M8496~M8503, you can view the status of each slave, if there is no connection, it will be turned ON

#### 1. Serial port 2

Master program:

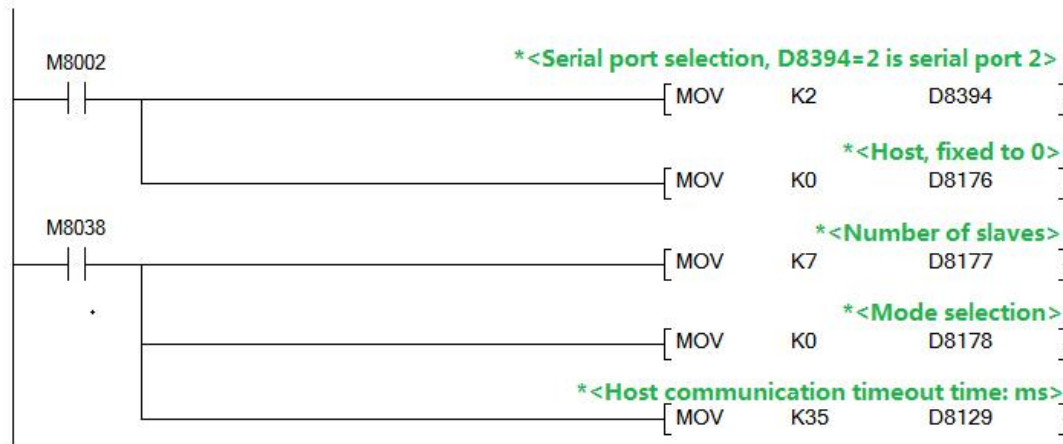

Slave program:

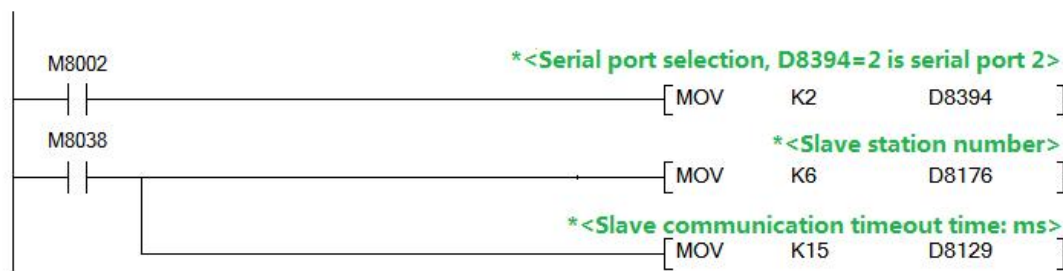

## 2. Serial port 3

Such as serial port 2, only need the master and slave program to set D8394=3

## 3. CAN port

Master program:

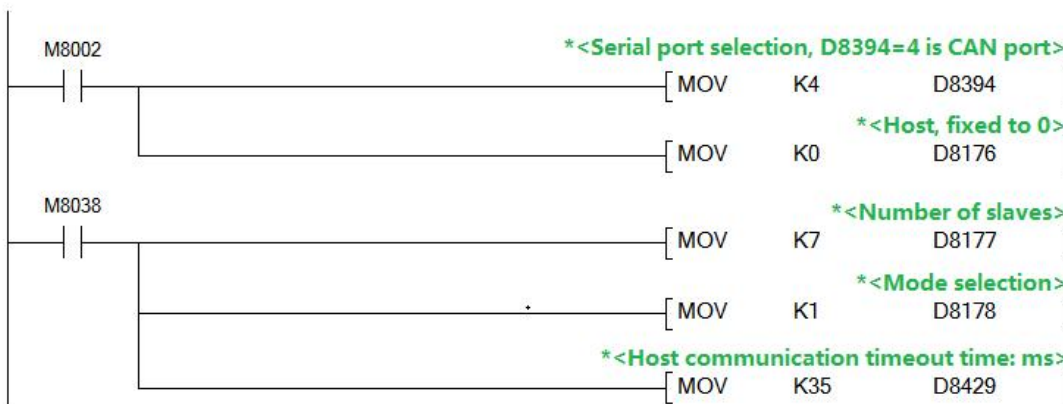

Slave program:

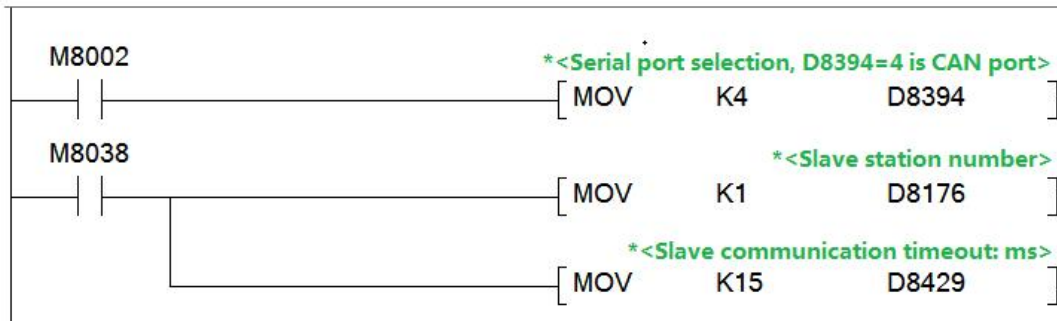

## 9. Coolmay L02 series PLC hardware identification and address allocation

The L02 series PLC host can expand digital and analog according to customer needs. This chapter introduces the hardware identification and address allocation of the extension module by the host.

### 9.1. Hardware identification of digital input and output modules

When the host detects the digital module, it will display the number of bytes of digital input and output in the corresponding designated register. The number of digital inputs and outputs is calculated in bytes, and every 8 inputs or 8 outputs counts as one byte.

If the extension module is correctly connected to the host, but the host does not detect the module (that is, the data in the register does not match the actual number of extension modules), please re-plug the host and the extension module.

Register	Function description
D8054	Number of digital input bytes
D8056	Number of digital output bytes

For example, the product is L02M24R + L02-16EX + L02-16ER, which expands 24 digital inputs and 8 digital outputs. Monitor the data of D8054 and D8056 as shown in the figure below.

Softcomponent	+F E D C	+B A 9 8	+7 6 5 4	+3 2 1 0	
D8054	0 0 0 0	0 0 0 0	0 0 0 0	0 0 1 1	3
D8055	0 0 0 0	0 0 0 0	0 0 0 0	0 0 0 0	0
D8056	0 0 0 0	0 0 0 0	0 0 0 0	0 0 0 1	1
D8057	0 0 0 0	0 0 0 0	0 0 0 0	0 0 0 0	0

## 9.2. Address allocation of digital input and output modules

When the host detects the expansion of the digital input and output, it will automatically sort from X20 or Y20 from left to right.

Take the host L02M24R, digital input modules L02-8EX and L02-16EX, and digital output modules L02-16EYR and L02-8EYT as examples. When the expansion module sequence is different, the address allocation is also different.

Sort one, the address of each expansion module is shown in the figure below.

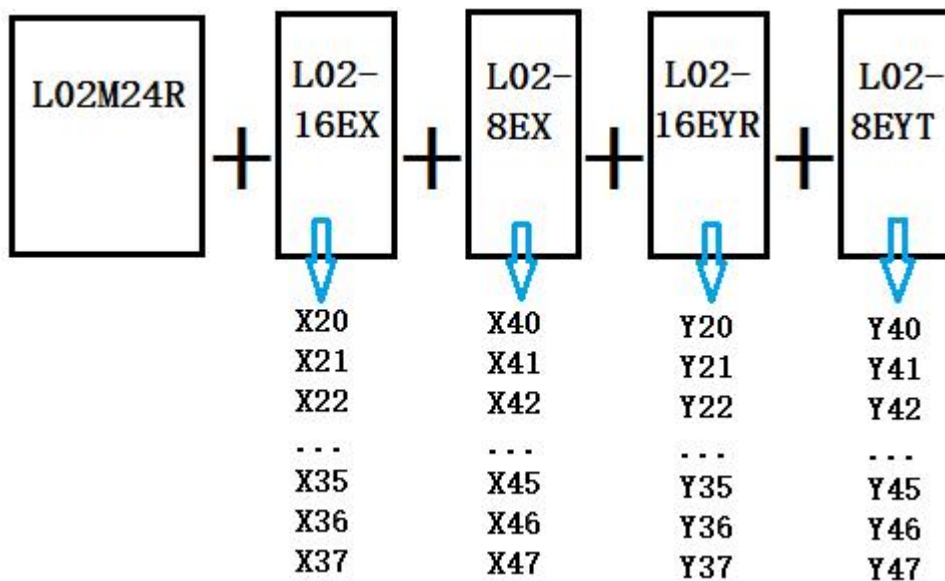

Sort two, the address of each expansion module is shown in the figure below.

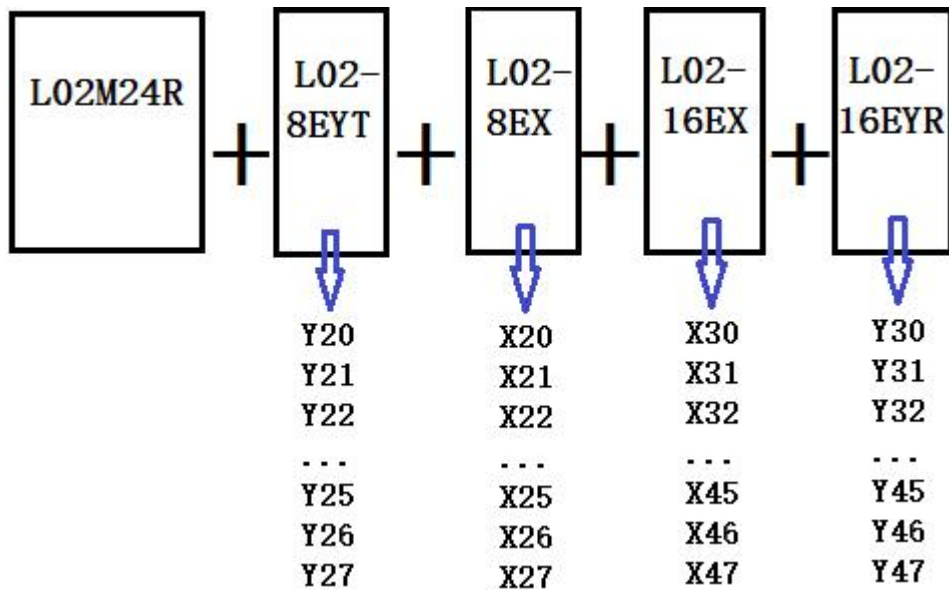

### 9.3. Hardware identification of analog input and output modules

When expanding the analog module, you need to set the type of each analog in the R23500~R23549 register of the host. For the correspondence between values and types, please refer to chapter 5.1.4.

The type is set correctly. When the host detects the analog module, it will display the number of analog input and output words (ie the number of channels) in the corresponding designated register.

If the extension module is correctly connected to the host, but the host does not detect the module (that is, the data in the register does not match the actual number of extension modules), please re-plug the host and the extension module.

Register	Function description
D8055	Number of analog input words
D8057	Number of analog output words

For example, the product is L02M24R + L02-4TC + L02-4DA+L02-4AD2DA, which is to extend 8 analog input and 6 analog output. You need to set the

value of R23500-R23507 in the R register of the host first (Note that the default is 0) as shown in the following table.

Monitor the data of D8055 and D8057 as shown in the figure below.

Softcomponent	+F E D C	+B A 9 8	+7 6 5 4	+3 2 1 0	
D8054	0 0 0 0	0 0 0 0	0 0 0 0	0 0 0 0	0
D8055	0 0 0 0	0 0 0 0	0 0 0 0	1 0 0 0	8
D8056	0 0 0 0	0 0 0 0	0 0 0 0	0 0 0 0	0
D8057	0 0 0 0	0 0 0 0	0 0 0 0	0 1 1 0	6

#### 9.4. Address reading of analog input and output modules

Refer to [Chapter 5.1.4](#) for analog input reading.

Refer to [Chapter 5.2.2](#) for analog output reading.

## Appendix Version Change Record

Date	Changed version	Change content
Aug. 2021	V21.81	<ul style="list-style-type: none"> <li>◆ 1.4 L02 series host and modules description--modified the description of power module</li> <li>◆ 7.3 Pulse width modulation PWM--5. Special instructions, changed the output frequency</li> </ul>
Dec.2021	V21.121	<ul style="list-style-type: none"> <li>◆ 3.1 Special Relays and Registers-Change Interpolation Flag Relay</li> </ul>
Feb.2022	V22.21	<ul style="list-style-type: none"> <li>◆ AB(Z) phase 2 channels 60KHz + AB phase 1 channel 10KHz changed to AB(Z) phase 2 channels 30KHz + AB phase 1 channel 5KHz</li> <li>◆ The high-speed pulse is modified to 4 channels of 100KHz+4 channels of 50KHz</li> <li>◆ 8.3.2 Mitsubishi BD Protocol Added</li> <li>◆ 8.6 Modification of some parameters</li> <li>◆ 8.6.1 MC protocol Added</li> </ul>
Aug. 2022	V22.81	<ul style="list-style-type: none"> <li>◆ L02-4RTD module changed to Pt100</li> <li>◆ Add module L02-16EYP</li> </ul>