

# Industrial communication

## Contents

### Industrial field bus

---

- GBS20 series field bus module A00~34
- GX series IP67 compact module B00~16
- GXC series IP67 extension module C00~16

### Industrial Switch

---

- Unmanaged Switch E04~08
- Managed Switch E09~16
- Three layer management Switch E17~20
- 10Gigabit Switch E21~24
- PoE Switch E25~27
- Profinet Switch E28~29
- IP67 Switch E30~30
- Photoelectric converter E31~32

### Industrial VPN router

---

- 3G wireless router F01~01
- WiFi wireless router F02~02

### Industrial communication accessories

---

I00~13



# GBS20 Series Extensible Module A

GBS20

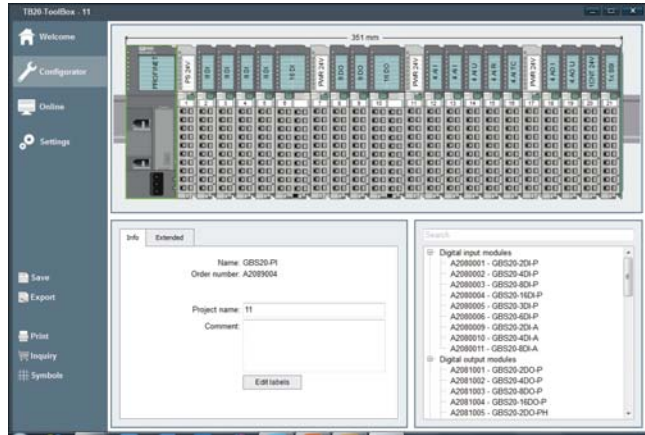
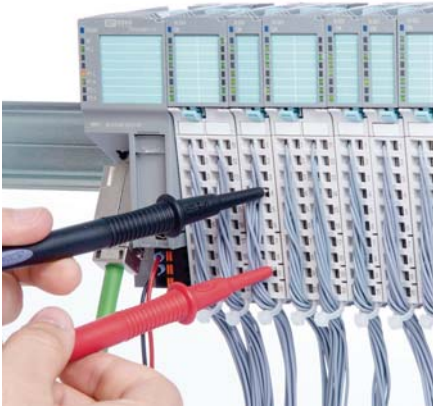

GBS20 series IP20 protection grade fieldbus products are rich in I/O signal connection, structured module design, module lock slideway connection, front wiring terminals and other unique design.

ToolBox diagnostic software, offline design of network nodes, understanding node parameters, node length, online diagnosis of node status, as well as online coercion, data monitoring and other functions.



GBS20 has the support of PROFINET, PROFIBUS-DP, CANOpen, Modbus/TCP, EtherNet/IP, DeviceNET and EtherCAT and so on Protocol coupler. It is convenient to assemble, replace the communication protocol only need to change coupler, the electronic module is universa.

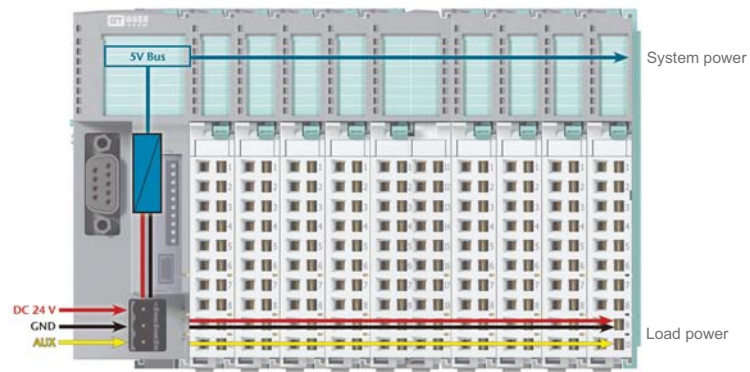

GBS20 series coupler power supply access unit provides system power supply (5VDC) and load power supply (24VDC) for the whole node



The GBS20-PF auxiliary power module can provide the load power for the subsequent expansion module, and form an independent power supply group

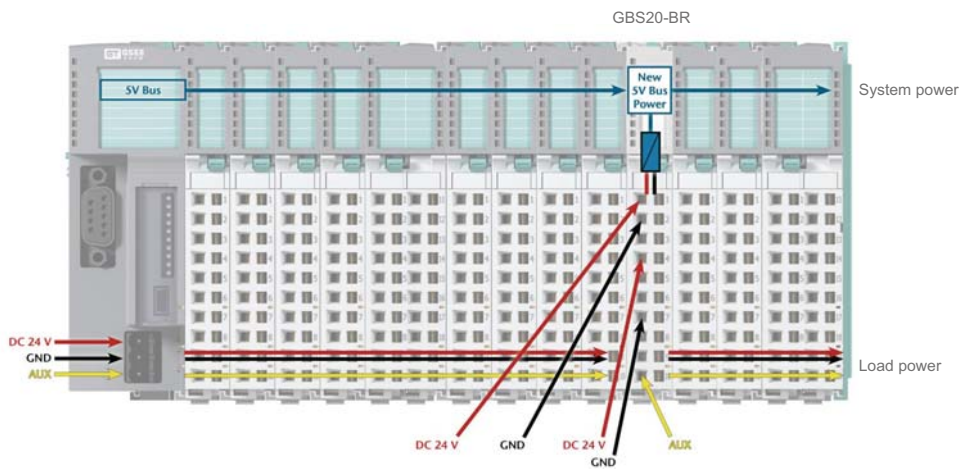

The GBS20-BR power supply module can provide system power and load power for the subsequent expansion module, and form an independent power supply group

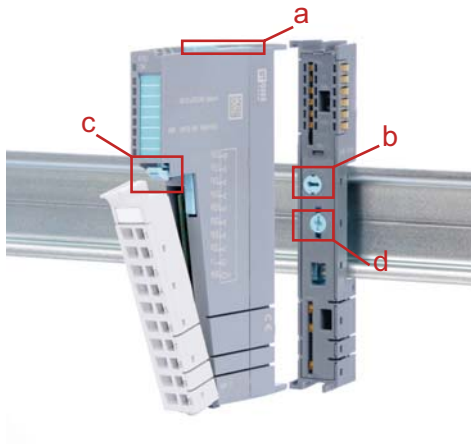

- Compact shape, compact structure, convenient combination
- The coupler and the module are composed of three parts: Body, front connection terminal and bottom plate (three parts are in the same model, no need to purchase separately)
- To replace the module body, it is necessary to separate the front terminals
- Then separate the body from the bottom
- In order to separate the backplane from the DIN guide rail, the locking of the floor locking plate should be removed

a、 Locking devices between the module and the bottom



b、 Misplug prevention device unique custom

The module and the bottom misplug prevention device is screwed to the corresponding position, namely the formation of custom anti misplugging encoding, effectively avoid misoperation, the position of the 8 set free, easy to have anti misplugging your own system



c、 The front terminal fast release lock design, easy separation of the front terminal and module, upward toggle lock, the front terminal can be easily pulled out



35mm  
DIN Guide  
OFF



35mm  
DIN Guide  
ON

- d、 Floor lock design is firm and stable, effectively avoid misoperation
- Latch release : -The bottom plate is allowed to be removed from the guide rail
- The body does not allow the insertion of the backplane
- Latch locking : -The bottom plate is not allowed to be removed from the guide rail
- Ontology allow insertion

GBS20 Dimensions

Module with width

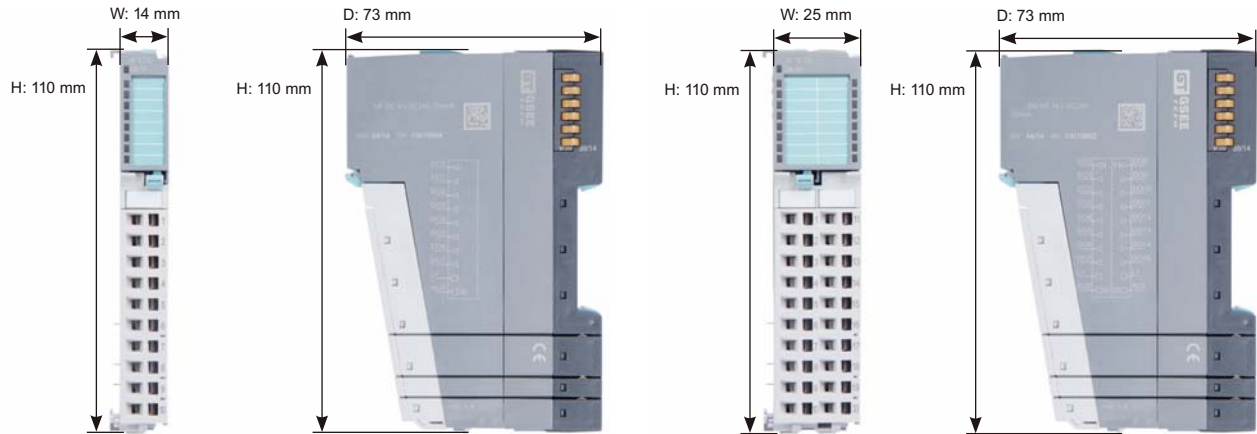

RS232 Communication module

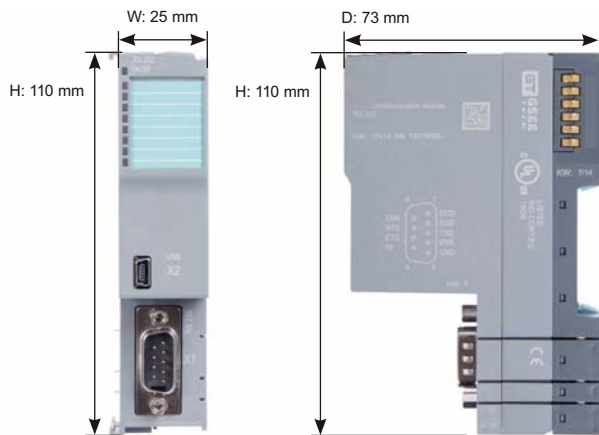

Bus Couplers

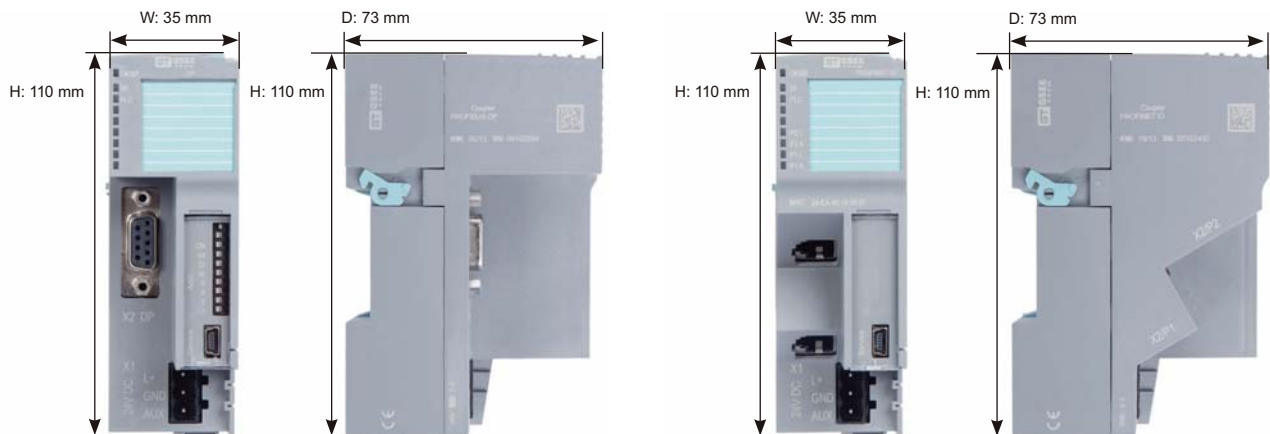



## GBS20 PROFINET Coupler

- I/O device as per PROFINET IO Integrated two-port switch
- 344 bytes of input data , 344 bytes of output data
- Supporting MRP ring network characteristics
- Modules can be replaced during operation (hot-plug)
- Integrated power supply unit for powering peripheral modules (2.5 A)
- GBS20 ToolBox simulation for setting up the I/O system



GBS20

### Technical specifications

Parameters	
Protocol	PROFINET IO
Connector	Two RJ45, integrated switch
Physical layer	Ethernet
Transmission rate	10/100Mbps, full-duplex
I/O image table size	344/344 bytes
Extension number	63
Features	IRT, Conformance Class C, MRP, Automatic addressing / topology discovery(LLDP/DCP), PTCP
Alarm functions	Diagnostic alarms, Process alarms, Pull/plug alarms
Minimum cycle time	250µsec.
IRT bridge delay	<3µsec.

USB Service Port	
Connector	Mini-USB
Purpose	ToolBox software can be used to realize the module configuration, firmware upgrade, online diagnosis and so on
Electrical isolation	Yes
Isolation voltage	1.5kV

Power Source	
Connector	Terminal connection
Voltage supply	24VDC ( 18...28VDC )
Current without loads	75mA
Power dissipation	Max. 8W
System power supply	5VDC, Max. 2.5A
System power supply	8A

Mechanical structure	
Protection rating	IP20
Dimensions(H x W x D)	110mm x 35mm x 73mm
Weight	115g
Installation method	Guide rail type

Work environment	
Ambient temperature	0 ~ 50°C
Storage temperature	-20 ~ 80°C
Relative humidity	5 ~ 95%RH ( without condensation )

LED Indicator light	
OK/BF	Blue: PROFINET communication is ok, normal configuration; red flash: PROFINET connection error
SF	Yellow / yellow flash: module failure, loss, inconsistent with the actual configuration
PLC	Green: communication with PLC system is normal
P1L/P2L	Huang: Link physical connection state
P1A/P2A	Green: ACT data transfer status

Ordering data	
Mode	GBS20-PI
Protocol	PROFINET IO Coupler
Product description	IP20 protection level, 0~50 ambient temperature, Guide rail installation

A05

GSEE TECH



**B.C.E. s.r.l.**

Via Regina Pacis, 54/c - 41049 SASSUOLO (MO) Italy  
 Tel. +39 0536 811.616 r.a. - Fax +39 0536 811.500  
 www.bce.it - E-mail: bce@bce.it



- I/O device as per ETHERNET/IP Integrated two-port switch
- 511 bytes of input data , 511 bytes of output data
- Automatic mapping of extended module I/O data
- Modules can be replaced during operation (hot-plug)
- Integrated power supply unit for powering peripheral modules (2.5 A)
- GBS20 ToolBox simulation for setting up the I/O system



**EtherNet/IP™**  
conformance tested

GBS20

#### Technical specifications

Parameters	
Connector	EtherNet/IP
Connector	2 x RJ45, integrated switch
Physical layer	Ethernet
Transmission rate	10/100Mbps, full-duplex
I/O image table size	511/511 bytes
Extension number	64
协议传输模型	Hermit message transfer (1 class transfer), display message transfer (3 class transfer)
IP Address	Software settings or DIP switches
DHCP	Through the DIP switch
USB Service Port	
Purpose and connector	Mini-USB , ToolBox software can be used to firmware upgrade, online diagnosis and so on
Electrical isolation	Yes
Isolation voltage	1.5kV
Power Source	
Connector	Terminal connection
Voltage supply	24VDC ( 18...28VDC )
Current without loads	75mA
Power dissipation	Max. 8W
System power supply	5VDC, Max. 2.5A
Load power supply	8A
Mechanical structure	
Protection rating	IP20
Dimensions(H x W x D)	110mm x 35mm x 73mm
Weight	115g
Installation method	Guide rail type
Work environment	
Ambient temperature	0 ~ 50°C
Storage temperature	-20 ~ 80°C
Relative humidity	5 ~ 95%RH ( without condensation )
LEDIndicator light	
OK/BF	Blue: the network communication is OK, configuration normal; red flash: network connection error
SF	Yellow / yellow flash: module failure, loss, and does not match the actual configuration
PLC	Green: communication with PLC system is normal
MS	Green: module normal; red flash: module error
NS	Not bright: module without IP; green: connection normal; green flash: device no connection; red: has assigned IP
P1L/P2L	Huang: Link physical connection state
P1A/P2A	Green: ACT data transfer status
Ordering data	
Mode	GBS20-EI
Protocol	EtherNet/IP Coupler
Product description	IP20 protection level, 0~50 ambient temperature, Guide rail installation

## GBS20 ETHERCAT Coupler

- I/O device as per EtherCAT Integrated two-port switch
- 1024 bytes of input data , 1024 bytes of output data
- Automatic mapping of extended module I/O data
- Modules can be replaced during operation (hot-plug)
- Integrated power supply unit for powering peripheral modules (2.5 A)
- GBS20 ToolBox simulation for setting up the I/O system



EtherCAT

GBS20

### Technical specifications

Parameters	
Protocol	EtherCAT
Connector	2 x RJ45
Physical layer	Ethernet
Transmission rate	100Mbps
I/O image table size	1024/1024 bytes
Extension numbe	64
EtherCAT function	Modular device description, CoE emergency message automatic mapping

USB Service Port	
Connector	Mini-USB
Purpose	ToolBox software can be used to realize the module configuration, firmware upgrade, online diagnosis and so on
Electrical isolation	Yes
Isolation voltage	1.5kV

Power Source	
Connector	Terminal connection
Voltage supply	24VDC ( 18...28VDC )
Current without loads	75mA
Power dissipation	Max. 8W
System power supply	5VDC, Max. 2.5A
Load power supply	8A

Mechanical structure	
Protection rating	IP20
Dimensions(H x W x D)	110mm x 35mm x 73mm
Weight	130g
Installation method	Guide rail type

Work environment	
Ambient temperature	0 ~ 50°C
Storage temperature	-20 ~ 80°C
Relative humidity	5 ~ 95%RH ( without condensation )

LED Indicator light	
OK/BF	Blue: communication is ok, normal configuration; red flash: PROFINET connection erro
SF	Yellow / yellow flash: module failure, loss, inconsistent with the actual configuration
PLC	Green: communication with PLC system is normal
P1L/P2L	Huang: Link physical connection state
P1A/P2A	Green: ACT data transfer status

Ordering data	
Mode	GBS20-EC
Protocol	ETHERCAT Coupler
Product description	IP20 protection level, 0~50 ambient temperature, Guide rail installation

- I/O device as per Modbus TCP/IP Integrated two-port switch
- 2048 bytes of input data , 2048 bytes of output data
- Automatic mapping of extended module I/O data
- Modules can be replaced during operation (hot-plug)
- Integrated power supply unit for powering peripheral modules (2.5 A)
- GBS20 ToolBox simulation for setting up the I/O system



Modbus TCP/IP

GBS20

## Technical specifications

Parameters	
Protocol	Modbus TCP/IP
Connector	Two RJ45, integrated switch
Physical layer	Ethernet
Transmission rate	10/100Mbps, automatic detection
I/O image table size	2048/2048 bytes
Module parameter	126 bytes
Extension number	64
Support function code	1 , 2 , 3 , 4 , 5 , 6 , 15 , 16 , 22 , 23
TCP connection	10 node

USB Service Port	
Connector	Mini-USB
Purpose	ToolBox software can be used to realize the module configuration, firmware upgrade, online diagnosis and so on
Electrical isolation	Yes
Isolation voltage	1.5kV

Power Source	
Connector	Terminal connection
Voltage supply	24VDC ( 18...28VDC )
Current without loads	75mA
Power dissipation	Max. 8W
System power supply	5VDC, Max. 2.5A
Load power supply	8A

Mechanical structure	
Protection rating	IP20
Dimensions(H x W x D)	110mm x 35mm x 73mm
Weight	115g
Installation method	Guide rail type

Work environment	
Ambient temperature	0 ~ 50°C
Storage temperature	-20 ~ 80°C
Relative humidity	5 ~ 95%RH ( without condensation )

LED Indicator light	
OK/BF	Blue: PROFINET communication is ok, normal configuration; red flash: PROFINET connection error
SF	Yellow / yellow flash: module failure, loss, inconsistent with the actual configuration
PLC	Green: communication with PLC system is normal
P1L/P2L	Huang: Link physical connection state
P1A/P2A	Green: ACT data transfer status

Ordering data	
Mode	GBS20-EN
Protocol	Modbus TCP/IP Coupler
Product description	IP20 protection level, 0~50 ambient temperature, Guide rail installation

## GBS20 PROFIBUS-DP Coupler

- 9 pin D-sub socket (9.6k-12Mbps, automatic detection)
- 244 bytes of input data , 244 bytes of output data
- Support DP-V0/DP-V1
- Modules can be replaced during operation (hot-plug)
- Integrated power supply unit for powering peripheral modules (2.5 A)
- GBS20 ToolBox simulation for setting up the I/O system



GBS20

### Technical specifications

Parameters	
Protocol	PROFIBUS DP-V0&DP-V1
Connector	9-pin D-sub Hole seat
Physical layer	RS485
Transmission rate	9.6 Kbaud~12 Mbaud , automatic detection
I/O image table size	244/244bytes
Extension number	64
Parameter length	244 bytes
USB Service Port	
Connector	Mini-USB
Purpose	ToolBox software can be used to realize the module configuration, firmware upgrade, online diagnosis and so on
Electrical isolation	Yes
Isolation voltage	1.5kV
Power Source	
Connector	Terminal connection
Voltage supply	24VDC ( 18...28VDC )
Current without loads	75mA
Power dissipation	Max. 8W
System power supply	5VDC, Max. 2.5A
Load power supply	8A
Mechanical structure	
Protection rating	IP20
Dimensions(H x W x D)	110mm x 35mm x 73mm
Weight	115g
Installation method	Guide rail type
Work environment	
Ambient temperature	0 ~ 50°C
Storage temperature	-20 ~ 80°C
Relative humidity	5 ~ 95%RH ( without condensation )
LED Indicator light	
OK/BF	Blue: PROFINET communication is ok, normal configuration; red flash: PROFINET connection erro
SF	Yellow / yellow flash: module failure, loss, inconsistent with the actual configuration
PLC	Green: communication with PLC system is normal
Ordering data	
Mode	GBS20-DP
Protocol	PROFIBUS DP Coupler
Product description	IP20 protection level, 0~50 ambient temperature, Guide rail installation

- Connect to the DEVICENET device through the open connector
- 1024 bytes of input data , 1024 bytes of output data
- The DIP switch sets the node ID and baud rate
- Modules can be replaced during operation (hot-plug)
- Integrated power supply unit for powering peripheral modules (2.5 A)
- GBS20 ToolBox simulation for setting up the I/O system

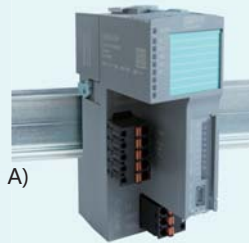

Technical specifications

Parameters	
Protocol	DEVICENET
Connector	Terminal connection
Physical layer	CAN
Transmission rate	125 , 250 , 500 Kbit/s , Auto
I/O image table size	1024/1024 bytes
Parameter length	120 bytes

USB Service Port	
Connector	Mini-USB
Purpose	ToolBox software can be used to realize the module configuration, firmware upgrade, online diagnosis and so on
Electrical isolation	Yes
Isolation voltage	1.5kV

Power Source	
Connector	Terminal connection
Voltage supply	24VDC ( 18...28VDC )
Current without loads	75mA
Power dissipation	Max. 8W
System power supply	5VDC, Max. 2.5A
Load power supply	8A

Mechanical structure	
Protection rating	IP20
Dimensions(H x W x D)	110mm x 35mm x 73mm
Weight	115g
Installation method	Guide rail type

Work environment	
Ambient temperature	0 ~ 50°C
Storage temperature	-20 ~ 80°C
Relative humidity	5 ~ 95%RH ( without condensation )

LED Indicator light	
OK/BF	Blue: PROFINET communication is ok, normal configuration; red flash: PROFINET connection erro
SF	Yellow / yellow flash: module failure, loss, inconsistent with the actual configuration
PLC	Green: communication with PLC system is normal
MS	Green: module normal; red flash: module error
NS	No light: no network power; green: connection normal; green flash: device no connection; red: error detected
I/O	Green: input and output signals; red: unrecoverable fault; red flash: short circuit or other diagnostic events

Ordering data	
Mode	GBS20-DN
Protocol	DEVICENET Coupler
Product description	IP20 protection level, 0~50 ambient temperature, Guide rail installation

## GBS20 CANopen Coupler

- 9 pin D-sub socket (9.6k-12Mbps, automatic detection)
- 24 TPDOs/24 RPDOs
- The DIP switch sets the node ID and baud rate
- Modules can be replaced during operation (hot-plug)
- Integrated power supply unit for powering peripheral modules (2.5 A)
- GBS20 ToolBox simulation for setting up the I/O system



CANopen

GBS20

### Technical specifications

Parameters	
Protocol	CANopen
Connector	9-pin D-sub Hole seat
Physical layer	CAN
Baud rate	50 , 100 , 125 , 250 , 500 , 800 , 1000 kpbs
TPDOs	24
RPDOs	24
Extension number	64
Interface	ISO 11898-2
USB Service Port	
Connector	Mini-USB
Purpose	ToolBox software can be used to realize the module configuration, firmware upgrade, online diagnosis and so on
Electrical isolation	Yes
Isolation voltage	1.5kV
Power Source	
Connector	Terminal connection
Voltage supply	24VDC ( 18...28VDC )
Current without loads	75mA
Power dissipation	Max. 8W
System power supply	5VDC, Max. 2.5A
Load power supply	8A
Mechanical structure	
Protection rating	IP20
Dimensions(H x W x D)	110mm x 35mm x 73mm
Weight	115g
Installation method	Guide rail type
Work environment	
Ambient temperature	0 ~ 50°C
Storage temperature	-20 ~ 80°C
Relative humidity	5 ~ 95%RH ( without condensation )
LED Indicator light	
OK/BF	Blue: PROFINET communication is ok, normal configuration; red flash: PROFINET connection erro
SF	Yellow / yellow flash: module failure, loss, inconsistent with the actual configuration
PLC	Green: communication with PLC system is normal
TX	Yellow: send CAN frames
RX	Green: CAN frame reception
Ordering data	
Mode	GBS20-CO
Protocol	CANopen Coupler
Product description	IP20 protection level, 0~50 ambient temperature, Guide rail installation



Parameters			
Number of inputs	4	8	16
Rated voltage	24 VDC		
Power supply	24 VDC		
Backplane isolation	Yes		
Channels isolation	No		
External current draw	Max.0mA		
Internal current draw	Max.22mA		Max.23mA
Power dissipation	Max.0.95W	Max.1.85W	Max.3.7W
Input characteristic curve	Type2 , EN 61131-2		
Polarity protection	Yes		
Output type	PNP		
For low signal ("0")	-3V~9V		
For low signal ("1")	12V~30V		
Hot-pluggable	Yes		
Connector	Spring		
Dimensions(HxWxD)	110mm x 14mm x 73mm		110mm x 25mm x 73mm
Weight	70g		110g
Installation method	Guide rail type		
Protection rating	IP20		
Ambient temperature	0°C~50°C		
Storage temperature	-20°C~80°C		
Relative humidity	5 ~ 95%RH ( without condensation )		

LED Indicator light	
OK	Blue: blue flash: normal module; module are not configured, red / red flash: module failure or configuration change
Channel light	Green: the channel input signal is normal

**Pin wiring diagram**

**GBS20-4DI-P**

pin assignment	
Terminal	Assignment
1	Input 0
2	Input 1
3	Input 2
4	Input 3
5	L+, 24 VDC
6	L+, 24 VDC
7	AUX
8	AUX
9	L+, 24 VDC
10	AUX

**GBS20-8DI-P**

pin assignment	
Terminal	Assignment
1	Input 0
2	Input 1
3	Input 2
4	Input 3
5	Input 4
6	Input 5
7	Input 6
8	Input 7
9	L+, 24 VDC
10	AUX

**GBS20-16DI-P**

pin assignment			
Terminal	Assignment	Terminal	Assignment
1	Input 0	11	Input 8
2	Input 1	12	Input 9
3	Input 2	13	Input 10
4	Input 3	14	Input 11
5	Input 4	15	Input 12
6	Input 5	16	Input 13
7	Input 6	17	Input 14
8	Input 7	18	Input 15
9	L+, 24 VDC	19	L+, 24 VDC
10	AUX	20	AUX



# GBS20 Digital Input Module

GBS20

## Module ordering data

GBS20  
Digital input module  
24VDC NPN



## Parameters

Number of inputs	8	16
Rated voltage	24 VDC	
Power supply	24 VDC	
Backplane isolation	Yes	
Channels isolation	No	
External current draw	Max.0mA	
Internal current draw	Max.22mA	Max.23mA
Power dissipation	Max.0.95W	Max.3.7W
Input characteristic curve	Type2 , EN 61131-2	
Polarity protection	Yes	
Output type	NPN	
For low signal ("0")	-3V~9V	
For High signal ("1")	12V~30V	
Hot-pluggable	Yes	
Connector	Spring	
Dimensions(HxWxD)	110mm x 14mm x 73mm	110mm x 25mm x 73mm
Weight	70g	110g
Installation method	Guide rail type	
Protection rating	IP20	
Ambient temperature	0°C~50°C	
Storage temperature	-20°C~80°C	
Relative humidity	5 ~ 95%RH ( without condensation )	

## LED Indicator light

OK	Blue/blue flash: normal module/module are not configured; red / red flash: module failure or configuration change
Channel light	Green: the channel input signal is normal

## Pin wiring diagram

Pin assignment	<p><b>GBS20-8DI-N</b></p> <table border="1"> <thead> <tr> <th colspan="2">pin assignment</th> </tr> <tr> <th>Terminal</th> <th>Assignment</th> </tr> </thead> <tbody> <tr><td>1</td><td>Input 0</td></tr> <tr><td>2</td><td>Input 1</td></tr> <tr><td>3</td><td>Input 2</td></tr> <tr><td>4</td><td>Input 3</td></tr> <tr><td>5</td><td>Input 4</td></tr> <tr><td>6</td><td>Input 5</td></tr> <tr><td>7</td><td>Input 6</td></tr> <tr><td>8</td><td>Input 7</td></tr> <tr><td>9</td><td>L+, 24VDC</td></tr> <tr><td>10</td><td>AUX</td></tr> </tbody> </table>	pin assignment		Terminal	Assignment	1	Input 0	2	Input 1	3	Input 2	4	Input 3	5	Input 4	6	Input 5	7	Input 6	8	Input 7	9	L+, 24VDC	10	AUX	<p><b>GBS20-16DI-N</b></p> <table border="1"> <thead> <tr> <th colspan="4">pin assignment</th> </tr> <tr> <th>Terminal</th> <th>Assignment</th> <th>Terminal</th> <th>Assignment</th> </tr> </thead> <tbody> <tr><td>1</td><td>Input 0</td><td>11</td><td>Input 8</td></tr> <tr><td>2</td><td>Input 1</td><td>12</td><td>Input 9</td></tr> <tr><td>3</td><td>Input 2</td><td>13</td><td>Input 10</td></tr> <tr><td>4</td><td>Input 3</td><td>14</td><td>Input 11</td></tr> <tr><td>5</td><td>Input 4</td><td>15</td><td>Input 12</td></tr> <tr><td>6</td><td>Input 5</td><td>16</td><td>Input 13</td></tr> <tr><td>7</td><td>Input 6</td><td>17</td><td>Input 14</td></tr> <tr><td>8</td><td>Input 7</td><td>18</td><td>Input 15</td></tr> <tr><td>9</td><td>L+, 24VDC</td><td>19</td><td>L+, 24 VDC</td></tr> <tr><td>10</td><td>AUX</td><td>20</td><td>AUX</td></tr> </tbody> </table>	pin assignment				Terminal	Assignment	Terminal	Assignment	1	Input 0	11	Input 8	2	Input 1	12	Input 9	3	Input 2	13	Input 10	4	Input 3	14	Input 11	5	Input 4	15	Input 12	6	Input 5	16	Input 13	7	Input 6	17	Input 14	8	Input 7	18	Input 15	9	L+, 24VDC	19	L+, 24 VDC	10	AUX	20	AUX
	pin assignment																																																																									
Terminal	Assignment																																																																									
1	Input 0																																																																									
2	Input 1																																																																									
3	Input 2																																																																									
4	Input 3																																																																									
5	Input 4																																																																									
6	Input 5																																																																									
7	Input 6																																																																									
8	Input 7																																																																									
9	L+, 24VDC																																																																									
10	AUX																																																																									
pin assignment																																																																										
Terminal	Assignment	Terminal	Assignment																																																																							
1	Input 0	11	Input 8																																																																							
2	Input 1	12	Input 9																																																																							
3	Input 2	13	Input 10																																																																							
4	Input 3	14	Input 11																																																																							
5	Input 4	15	Input 12																																																																							
6	Input 5	16	Input 13																																																																							
7	Input 6	17	Input 14																																																																							
8	Input 7	18	Input 15																																																																							
9	L+, 24VDC	19	L+, 24 VDC																																																																							
10	AUX	20	AUX																																																																							
Wiring diagram																																																																										

Module ordering data

GBS20  
Digital AC input module  
230VAC

GBS20-8DI-A



Per channel N  
Type1  
230VAC

Parameters

Number of inputs	8
Backplane isolation	Yes
Channels isolation	Yes
External current draw	Max.0mA
Internal current draw	Max.22mA
Power dissipation	Max.15.2W
Input characteristic curve	Type1 , EN 61131-2
Input frequency	50Hz / 60Hz
For low signal voltage	0V~40V
For High signal voltage	79V~253V
Hot-pluggable	Yes
Connector	Spring
Dimensions(HxWxD)	110mm x 25mm x 73mm
Weight	110g
Installation method	Guide rail type
Protection rating	IP20
Ambient temperature	0°C~50°C
Storage temperature	-20°C~80°C
Relative humidity	5 ~ 95%RH ( without condensation )

LED Indicator light

OK	Blue flash: module are not configured;red / red flash: module failure or configuration change
Channel light	Green: the channel input signal is normal

Pin wiring diagram

Pin assignment  
Wiring diagram

pin assignment			
Terminal	Assignment	Terminal	Assignment
1	Input 0 L	11	Input 4 L
2	Input 0 N	12	Input 4 N
3	Input 1 L	13	Input 5 L
4	Input 1 N	14	Input 5 N
5	Input 2 L	15	Input 6 L
6	Input 2 N	16	Input 6 N
7	Input 3 L	17	Input 7 L
8	Input 3 N	18	Input 7 N
9		19	
10	AUX	20	AUX

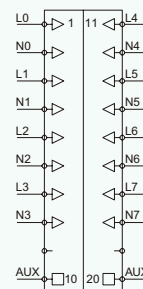

# GBS20 Digital In/output Module

GBS20

## Module ordering data

GBS20  
Digital input/output module  
24VDC PNP  
500mA

GBS20-8DI8DO-P



8DI8DO  
24VDC PNP  
500mA

## Parameters

Number of inputs	8
Input characteristic curve	Type2 , EN 61131-2
Polarity protection	Yes
For low signal voltage	-3V~9V
For High signal voltage	12V~30V
Number of outputs	8
Supply voltage	
-Rated value	24 VDC
-Ripple	Max.3.6V
-Allowable range	20~30V
Output current	
-Rated value	500mA
-Leakage current	Max.0.5mA
Output short-circuit protection	Yes
External current draw	Max.40mA+load
Internal current draw	Max.35mA
Power dissipation	Max.4.35W
Backplane isolation	Yes
Hot-pluggable	Yes
Connector	Spring
Dimensions(HxWxD)	110mm x 25mm x 73mm
Weight	110g
Installation method	Guide rail type
Protection rating	IP20
Ambient temperature	0°C~50°C
Storage temperature	-20°C~80°C
Relative humidity	5 ~ 95%RH ( without condensation )

## LED Indicator light

OK	Blue flash: module are not configured;red / red flash: module failure or configuration change
Channel light	Green: the channel input signal is normal

## Pin wiring diagram

Pin assignment  
Wiring diagram

pin assignment			
Terminal	Assignment	Terminal	Assignment
1	Output 0	11	Input 0
2	Output 1	12	Input 1
3	Output 2	13	Input 2
4	Output 3	14	Input 3
5	Output 4	15	Input 4
6	Output 5	16	Input 5
7	Output 6	17	Input 6
8	Output 7	18	Input 7
9	L+, 24 VDC	19	L+, 24 VDC
10	AUX	20	AUX

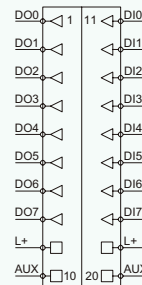



Parameters			
Number of outputs	4	8	16
Power supply	24 VDC		
Backplane isolation	Yes		
Channels isolation	No		
Supply voltage			
-Rated value	24 VDC		
-Ripple	Max.3.6V		
-Allowable range	20~30V		
Output current			
-Rated value	500mA		
-Leakage current	Max.0.5mA		
External current draw	Max.20mA+load	Max.40mA+load	Max.80mA+load
Internal current draw	Max.30mA	Max.35mA	Max.47mA
Power dissipation	Max.1.0W	Max.2.5W	Max.5.0W
Polarity protection	Yes		
Output type	PNP		
Hot-pluggable	Yes		
Connector	Spring		
Dimensions(HxWxD)	110mm x 14mm x 73mm		110mm x 25mm x 73mm
Weight	70g		110g
Installation method	Guide rail type		
Protection rating	IP20		
Ambient temperature	0°C~50°C		
Storage temperature	-20°C~80°C		
Relative humidity	5 ~ 95%RH ( without condensation )		

LED Indicator light	
OK	Blue/blue flash: normal module/ module are not configured; red / red flash: module failure or configuration change
Channel light	Green: the channel input signal is normal

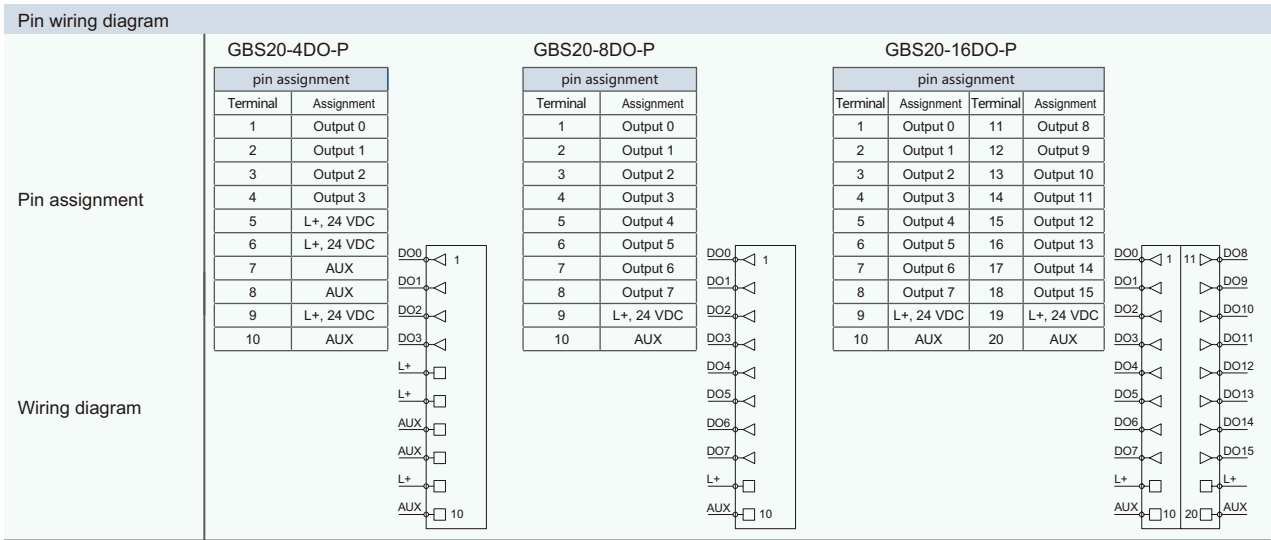

# GBS20 Digital Output Module

GBS20

## Module ordering data

GBS20  
Digital output module  
24VDC NPN  
300mA

GBS20-8DO-N



GBS20-16DO-N



## Parameters

Number of outputs	8	16
Power supply	24 VDC	
Backplane isolation	Yes	
Channels isolation	No	
Supply voltage		
-Rated value	24 VDC	
-Ripple	Max.3.6V	
-Allowable range	20~30V	
Output current		
-Rated value	300mA	
-Leakage current	Max.0.3mA	
External current draw	Max.40mA+load	Max.80mA+load
Internal current draw	Max.35mA	Max.47mA
Power dissipation	Max.2.5W	Max.5.0W
Backplane isolation	Yes	
Output type	NPN	
Hot-pluggable	Yes	
Connector	Spring	
Dimensions(HxWxD)	110mm x 14mm x 73mm	110mm x 25mm x 73mm
Weight	70g	110g
Installation method	Guide rail type	
Protection rating	IP20	
Ambient temperature	0°C~50°C	
Storage temperature	-20°C~80°C	
Relative humidity	5 ~ 95%RH ( without condensation )	

## LED Indicator light

OK	Blue/blue flash: normal module/ module are not configured; red / red flash: module failure or configuration change
Channel light	Green: the channel input signal is normal

## Pin wiring diagram

Pin assignment	<p>GBS20-8DO-N</p> <table border="1"> <thead> <tr> <th colspan="2">pin assignment</th> </tr> <tr> <th>Terminal</th> <th>Assignment</th> </tr> </thead> <tbody> <tr><td>1</td><td>Output 0</td></tr> <tr><td>2</td><td>Output 1</td></tr> <tr><td>3</td><td>Output 2</td></tr> <tr><td>4</td><td>Output 3</td></tr> <tr><td>5</td><td>Output 4</td></tr> <tr><td>6</td><td>Output 5</td></tr> <tr><td>7</td><td>Output 6</td></tr> <tr><td>8</td><td>Output 7</td></tr> <tr><td>9</td><td>GND</td></tr> <tr><td>10</td><td>AUX</td></tr> </tbody> </table>	pin assignment		Terminal	Assignment	1	Output 0	2	Output 1	3	Output 2	4	Output 3	5	Output 4	6	Output 5	7	Output 6	8	Output 7	9	GND	10	AUX	<p>GBS20-16DO-N</p> <table border="1"> <thead> <tr> <th colspan="4">pin assignment</th> </tr> <tr> <th>Terminal</th> <th>Assignment</th> <th>Terminal</th> <th>Assignment</th> </tr> </thead> <tbody> <tr><td>1</td><td>Output 0</td><td>11</td><td>Output 8</td></tr> <tr><td>2</td><td>Output 1</td><td>12</td><td>Output 9</td></tr> <tr><td>3</td><td>Output 2</td><td>13</td><td>Output 10</td></tr> <tr><td>4</td><td>Output 3</td><td>14</td><td>Output 11</td></tr> <tr><td>5</td><td>Output 4</td><td>15</td><td>Output 12</td></tr> <tr><td>6</td><td>Output 5</td><td>16</td><td>Output 13</td></tr> <tr><td>7</td><td>Output 6</td><td>17</td><td>Output 14</td></tr> <tr><td>8</td><td>Output 7</td><td>18</td><td>Output 15</td></tr> <tr><td>9</td><td>GND</td><td>19</td><td>GND</td></tr> <tr><td>10</td><td>AUX</td><td>20</td><td>AUX</td></tr> </tbody> </table>	pin assignment				Terminal	Assignment	Terminal	Assignment	1	Output 0	11	Output 8	2	Output 1	12	Output 9	3	Output 2	13	Output 10	4	Output 3	14	Output 11	5	Output 4	15	Output 12	6	Output 5	16	Output 13	7	Output 6	17	Output 14	8	Output 7	18	Output 15	9	GND	19	GND	10	AUX	20	AUX
	pin assignment																																																																									
Terminal	Assignment																																																																									
1	Output 0																																																																									
2	Output 1																																																																									
3	Output 2																																																																									
4	Output 3																																																																									
5	Output 4																																																																									
6	Output 5																																																																									
7	Output 6																																																																									
8	Output 7																																																																									
9	GND																																																																									
10	AUX																																																																									
pin assignment																																																																										
Terminal	Assignment	Terminal	Assignment																																																																							
1	Output 0	11	Output 8																																																																							
2	Output 1	12	Output 9																																																																							
3	Output 2	13	Output 10																																																																							
4	Output 3	14	Output 11																																																																							
5	Output 4	15	Output 12																																																																							
6	Output 5	16	Output 13																																																																							
7	Output 6	17	Output 14																																																																							
8	Output 7	18	Output 15																																																																							
9	GND	19	GND																																																																							
10	AUX	20	AUX																																																																							
Wiring diagram																																																																										

Module ordering data		
GBS20 Digital output module 24VDC PNP	<b>GBS20-8DO-P/HF</b> 	<b>GBS20-4DO-PH</b> 
	700mA PNP	2A PNP

Parameters		
Number of outputs	8	4
Power supply	24 VDC	
Backplane isolation	Yes	
Channels isolation	No	
Supply voltage		
-Rated value	24 VDC	
-Ripple	Max.3.6V	
-Allowable range	20~30V	
Output current		
-Rated value	700mA	2A
-Leakage current	Max.0.5mA	Max.0.5mA
External current draw	Max.40mA+load	Max.30mA+load
Internal current draw	Max.35mA	Max.30mA
Power dissipation	Max.1.0W	Max.1.1W
Polarity protection	Yes	
Output type	PNP	
Hot-pluggable	Yes	
Connector	Spring	
Dimensions(HxWxD)	110mm x 14mm x 73mm	
Weight	70g	
Installation method	Guide rail type	
Protection rating	IP20	
Ambient temperature	0°C~50°C	
Storage temperature	-20°C~80°C	
Relative humidity	5 ~ 95%RH ( without condensation )	

LED Indicator light	
OK	Blue/blue flash: normal module/ module are not configured; red / red flash: module failure or configuration change
Channel light	Green: the channel input signal is normal

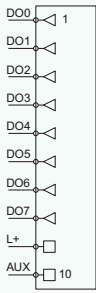
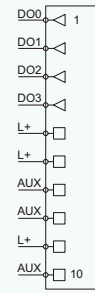
Pin wiring diagram																										
Pin assignment	<table border="1"> <thead> <tr> <th colspan="2">pin assignment</th> </tr> <tr> <th>Terminal</th> <th>Assignment</th> </tr> </thead> <tbody> <tr><td>1</td><td>Output 0</td></tr> <tr><td>2</td><td>Output 1</td></tr> <tr><td>3</td><td>Output 2</td></tr> <tr><td>4</td><td>Output 3</td></tr> <tr><td>5</td><td>Output 4</td></tr> <tr><td>6</td><td>Output 5</td></tr> <tr><td>7</td><td>Output 6</td></tr> <tr><td>8</td><td>Output 7</td></tr> <tr><td>9</td><td>L+, 24 VDC</td></tr> <tr><td>10</td><td>AUX</td></tr> </tbody> </table>	pin assignment		Terminal	Assignment	1	Output 0	2	Output 1	3	Output 2	4	Output 3	5	Output 4	6	Output 5	7	Output 6	8	Output 7	9	L+, 24 VDC	10	AUX	
	pin assignment																									
Terminal	Assignment																									
1	Output 0																									
2	Output 1																									
3	Output 2																									
4	Output 3																									
5	Output 4																									
6	Output 5																									
7	Output 6																									
8	Output 7																									
9	L+, 24 VDC																									
10	AUX																									
Wiring diagram	<table border="1"> <thead> <tr> <th colspan="2">pin assignment</th> </tr> <tr> <th>Terminal</th> <th>Assignment</th> </tr> </thead> <tbody> <tr><td>1</td><td>Output 0</td></tr> <tr><td>2</td><td>Output 1</td></tr> <tr><td>3</td><td>Output 2</td></tr> <tr><td>4</td><td>Output 3</td></tr> <tr><td>5</td><td>L+, 24 VDC</td></tr> <tr><td>6</td><td>L+, 24 VDC</td></tr> <tr><td>7</td><td>AUX</td></tr> <tr><td>8</td><td>AUX</td></tr> <tr><td>9</td><td>L+, 24 VDC</td></tr> <tr><td>10</td><td>AUX</td></tr> </tbody> </table>	pin assignment		Terminal	Assignment	1	Output 0	2	Output 1	3	Output 2	4	Output 3	5	L+, 24 VDC	6	L+, 24 VDC	7	AUX	8	AUX	9	L+, 24 VDC	10	AUX	
pin assignment																										
Terminal	Assignment																									
1	Output 0																									
2	Output 1																									
3	Output 2																									
4	Output 3																									
5	L+, 24 VDC																									
6	L+, 24 VDC																									
7	AUX																									
8	AUX																									
9	L+, 24 VDC																									
10	AUX																									

# GBS20 Relay Output Module

GBS20

## Module ordering data

GBS20  
Relay output

GBS20-4DO-R



Relay  
230VAC  
5A

## Parameters

Number of outputs	4
Backplane isolation	Yes
Channels isolation	Yes
Supply voltage	
-Rated value	24 VDC
-Ripple	Max.3.6V
-Allowable range	20~30V
External current draw	Max.60mA
Internal current draw	Max.60mA
Power dissipation	Max.2.5W
Relay	4
Maximum sustained current	5A / 10A
Rated voltage	250VAC / 400VAC
Maximum segmented capacity for load AC1	1,500VA
Maximum segmented capacity for load AC15 (230VAC)	300VA
Single phase motor load for AC3 (230VAC)	0.185kW
The maximum switching current is DC1 (30/110/220V)	6/ 0.2/ 0.12A
Minimum sectional capacity	500mW(12V/ 10mA)
Mechanical life	10x10 <sup>6</sup>
Electrical life	60,000
Coil insulation strength	6kV(8mm)
Insulation strength of open contact	1,000VAC
Maximum switching frequency	10Hz
Hot-pluggable	Yes
Connector	Spring
Dimensions(HxWxD)	110mm x 25mm x 73mm
Weight	120g
Installation method	Guide rail type
Protection rating	IP20
Ambient temperature	0°C~50°C
Storage temperature	-20°C~80°C
Relative humidity	5 ~ 95%RH ( without condensation )

## LED Indicator light

OK	Blue flash: module are not configured; red / red flash: module failure or configuration change
Channel light	Green: the channel input signal is normal

## Pin wiring diagram

Pin assignment  
Wiring diagram

pin assignment			
Terminal	Assignment	Terminal	Assignment
1	Relay 0, "NC"	11	Relay 2, "NC"
2	Relay 0, "common"	12	Relay 2, "common"
3	Relay 0, "NO"	13	Relay 2, "NO"
4	n.c.	14	n.c.
5	Relay 1, "NC"	15	Relay 3, "NC"
6	Relay 1, "common"	16	Relay 3, "common"
7	Relay 1, "NO"	17	Relay 3, "NO"
8	n.c.	18	n.c.
9	L+, 24 VDC	19	L+, 24 VDC
10	AUX	20	AUX

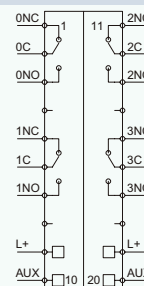



Parameters		
Number of inputs	4	
Backplane isolation	Yes	
Channels isolation	No	Yes
External current draw	Unnecessary	
Internal current draw	Max.95mA	Max.140mA
Power dissipation	Max.0.7W	Max.1.0W
Measuring range	0~20mA / 50Ω 4~20mA / 50Ω ±20mA / 50Ω	
Measurement resolution	12bits + sign	15bits + sign
Frequency suppression	None   10Hz   50Hz   60Hz   400Hz	
Diagnosis	The upper limit of measurement range exceeded (overflow) The measuring range limit exceeded (underflow) Disconnection (only in 4~20mA) Parameter assignment error	
Process alarm	Upper / lower limit of each channel	
Error range		
Operating error	±0.5%	±0.2%
Basic error	±0.3% @ 25°C	±0.1% @ 25°C
Temperature error	±0.005% / K	±0.005% / K
Linear error	±0.05% / K	±0.05% / K
Repeatability accuracy	±0.05% / K	±0.05% / K
Parameter length	22bytes	24bytes
error indicator	Red LED	
Hot-pluggable	Yes	
Dimensions(HxWxD)	110mm x 14mm x 73mm	
Weight	70g	80g
Installation method	Guide rail type	
Protection rating	IP20	
Ambient temperature	0°C~50°C	
Storage temperature	-20°C~80°C	
Relative humidity	5 ~ 95%RH ( without condensation )	

LED Indicator light	
OK	Blue/blue flash: normal module/ module are not configured; red / red flash: module failure or configuration change
Channel light	Green: the channel input signal is normal

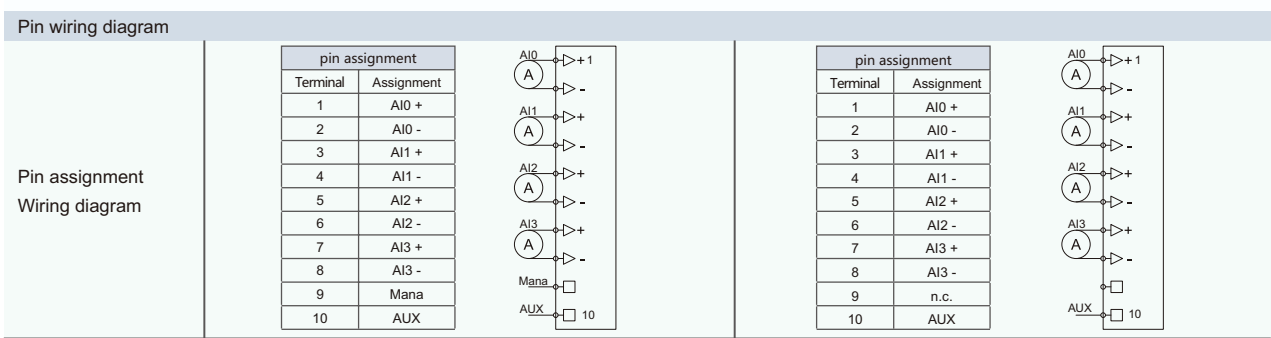



# GBS20 Analog Input Module

GBS20

## Module ordering data

GBS20  
4 channel current input  
0~10V  
1~5V  
±10V

GBS20-4AI-U



GBS20-4AI-U/iso



## Parameters

Number of inputs	4	
Backplane isolation	Yes	
Channels isolation	No	Yes
External current draw	Unnecessary	
Internal current draw	Max.95mA	Max.140mA
Power dissipation	Max.0.7W	Max.1.0W
Measuring range	0~10V / 10MΩ 1~5V / 10MΩ ±10V / 10MΩ , ±5V / 10MΩ , ±2.5V / 10MΩ	
Measurement resolution	12bits + sign	15bits + sign
Frequency suppression	None   10Hz   50Hz   60Hz   400Hz	
Diagnosis	The upper limit of measurement range exceeded (overflow) The measuring range limit exceeded (underflow) Disconnection (only in 4~20mA) Parameter assignment error	
Process alarm	Upper / lower limit of each channel	
Error range		
Operating error	±0.5%	±0.2%
Basic error	±0.3% @ 25°C	±0.1% @ 25°C
Temperature error	±0.005% / K	±0.005% / K
Linear error	±0.05% / K	±0.05% / K
Repeatability accuracy	±0.05% / K	±0.05% / K
Parameter length	22bytes	24bytes
error indicator	Red LED	
Hot-pluggable	Yes	
Dimensions(HxWxD)	110mm x 14mm x 73mm	
Weight	70g	80g
Installation method	Guide rail type	
Protection rating	IP20	
Ambient temperature	0°C~50°C	
Storage temperature	-20°C~80°C	
Relative humidity	5 ~ 95%RH ( without condensation )	

## LED Indicator light

OK	Blue/blue flash: normal module/ module are not configured; red / red flash: module failure or configuration change
Channel light	Green: the channel input signal is normal

## Pin wiring diagram

Pin assignment Wiring diagram	<table border="1"> <thead> <tr> <th colspan="2">pin assignment</th> </tr> <tr> <th>Terminal</th> <th>Assignment</th> </tr> </thead> <tbody> <tr><td>1</td><td>AI0 +</td></tr> <tr><td>2</td><td>AI0 -</td></tr> <tr><td>3</td><td>AI1 +</td></tr> <tr><td>4</td><td>AI1 -</td></tr> <tr><td>5</td><td>AI2 +</td></tr> <tr><td>6</td><td>AI2 -</td></tr> <tr><td>7</td><td>AI3 +</td></tr> <tr><td>8</td><td>AI3 -</td></tr> <tr><td>9</td><td>Mana</td></tr> <tr><td>10</td><td>AUX</td></tr> </tbody> </table>	pin assignment		Terminal	Assignment	1	AI0 +	2	AI0 -	3	AI1 +	4	AI1 -	5	AI2 +	6	AI2 -	7	AI3 +	8	AI3 -	9	Mana	10	AUX	<table border="1"> <thead> <tr> <th colspan="2">pin assignment</th> </tr> <tr> <th>Terminal</th> <th>Assignment</th> </tr> </thead> <tbody> <tr><td>1</td><td>AI0 +</td></tr> <tr><td>2</td><td>AI0 -</td></tr> <tr><td>3</td><td>AI1 +</td></tr> <tr><td>4</td><td>AI1 -</td></tr> <tr><td>5</td><td>AI2 +</td></tr> <tr><td>6</td><td>AI2 -</td></tr> <tr><td>7</td><td>AI3 +</td></tr> <tr><td>8</td><td>AI3 -</td></tr> <tr><td>9</td><td>n.c.</td></tr> <tr><td>10</td><td>AUX</td></tr> </tbody> </table>	pin assignment		Terminal	Assignment	1	AI0 +	2	AI0 -	3	AI1 +	4	AI1 -	5	AI2 +	6	AI2 -	7	AI3 +	8	AI3 -	9	n.c.	10	AUX
	pin assignment																																																	
Terminal	Assignment																																																	
1	AI0 +																																																	
2	AI0 -																																																	
3	AI1 +																																																	
4	AI1 -																																																	
5	AI2 +																																																	
6	AI2 -																																																	
7	AI3 +																																																	
8	AI3 -																																																	
9	Mana																																																	
10	AUX																																																	
pin assignment																																																		
Terminal	Assignment																																																	
1	AI0 +																																																	
2	AI0 -																																																	
3	AI1 +																																																	
4	AI1 -																																																	
5	AI2 +																																																	
6	AI2 -																																																	
7	AI3 +																																																	
8	AI3 -																																																	
9	n.c.																																																	
10	AUX																																																	

Module ordering data	
GBS20 Analog input module	GBS20-4AI-U (±24V/ 0~24V)    ±24V 0~24V 12Bit

Parameters	
Number of inputs	4
Backplane isolation	Yes
Channels isolation	No
External current draw	Unnecessary
Internal current draw	Max.95mA
Power dissipation	Max.0.7W
Measuring range	0~24V / 10MΩ ±24V / 10MΩ
Measurement resolution	12bits + sign
Frequency suppression	None   10Hz   50Hz   60Hz   400Hz
Diagnosis	The upper limit of measurement range exceeded (overflow) The measuring range limit exceeded (underflow) Parameter assignment error
Process alarm	Upper / lower limit of each channel
Error range	
Operating error	±0.5%
Basic error	±0.3% @ 25°C
Temperature error	±0.005% / K
Linear error	±0.05% / K
Repeatability accuracy	±0.05% / K
Parameter length	22bytes
error indicator	Red LED
Hot-pluggable	Yes
Dimensions(HxWxD)	110mm x 14mm x 73mm
Weight	70g
Installation method	Guide rail type
Protection rating	IP20
Ambient temperature	0°C~50°C
Storage temperature	-20°C~80°C
Relative humidity	5 ~ 95%RH ( without condensation )

LED Indicator light	
OK	Blue flash: module are not configured; red / red flash: module failure or configuration change
Channel light	Green: the channel input signal is normal

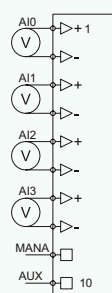
Pin wiring diagram																									
Pin assignment Wiring diagram	<table border="1" style="display: inline-table; margin-right: 20px;"> <thead> <tr> <th colspan="2">pin assignment</th> </tr> <tr> <th>Terminal</th> <th>Assignment</th> </tr> </thead> <tbody> <tr><td>1</td><td>AI0 +</td></tr> <tr><td>2</td><td>AI0 -</td></tr> <tr><td>3</td><td>AI1 +</td></tr> <tr><td>4</td><td>AI1 -</td></tr> <tr><td>5</td><td>AI2 +</td></tr> <tr><td>6</td><td>AI2 -</td></tr> <tr><td>7</td><td>AI3 +</td></tr> <tr><td>8</td><td>AI3 -</td></tr> <tr><td>9</td><td>Mana</td></tr> <tr><td>10</td><td>AUX</td></tr> </tbody> </table> 	pin assignment		Terminal	Assignment	1	AI0 +	2	AI0 -	3	AI1 +	4	AI1 -	5	AI2 +	6	AI2 -	7	AI3 +	8	AI3 -	9	Mana	10	AUX
pin assignment																									
Terminal	Assignment																								
1	AI0 +																								
2	AI0 -																								
3	AI1 +																								
4	AI1 -																								
5	AI2 +																								
6	AI2 -																								
7	AI3 +																								
8	AI3 -																								
9	Mana																								
10	AUX																								

# GBS20 Analog Input Module

GBS20

## Module ordering data

GBS20  
2/4 channel thermal  
resistance input  
&  
4 channel  
Thermocouple Input

GBS20-2/4AI-PT



GBS20-4AI-TC/iso



## Parameters

Number of inputs	4 channel (2 wire signal) or 2 channel (3/4 line signal)	4
Backplane isolation	Yes	
Channels isolation	No	Yes
External current draw	Unnecessary	
Internal current draw	Max.140mA	Max.95mA
Power dissipation	Max.1.0W	Max.0.7W
Signal type	150Ω, 300Ω, 600Ω, 3,000Ω, 6,000Ω Pt100, Pt1000 Ni100, Ni1000, LG-Ni1000	E(-270 ~ 990°C), S(-50 ~ 1,775°C), J(-210 ~ 1,200°C) T(-270 ~ 405°C), K(-270 ~ 1,380°C), B(0 ~ 1,800°C) N(-270 ~ 1320°C), C(0 ~ 2,320°C), R(-50 ~ 1,775°C) L(0 ~ 900°C)
Measurement resolution	15bits + sign	
Frequency suppression	None   10Hz   50Hz   60Hz   400Hz	
Diagnosis	Beyond the upper limit of measurement range (overflow), the measuring range limit exceeded (underflow) Break Parameter assignment error	
Process alarm	Upper / lower limit of each channel	
Error range		
Operating error	±0.5%	
Basic error	±0.3% @ 25°C	
Temperature error	±0.005% / K	
Linear error	±0.05% / K	
Repeatability accuracy	±0.05% / K	
Parameter length	26bytes	
error indicator	Red LED	
Hot-pluggable	Yes	
Dimensions(HxWxD)	110mm x 14mm x 73mm	
Weight	70g	
Installation method	Guide rail type	
Protection rating	IP20	
Ambient temperature	0°C~50°C	
Storage temperature	-20°C~80°C	
Relative humidity	5 ~ 95%RH ( without condensation )	

## LED Indicator light

OK	Blue/blue flash: normal module/ module are not configured; red / red flash: module failure or configuration change
Channel light	Green: the channel input signal is normal

## Pin wiring diagram

Pin assignment Wiring diagram	<table border="1"> <thead> <tr> <th colspan="2">pin assignment</th> </tr> <tr> <th>Terminal</th> <th>Assignment</th> </tr> </thead> <tbody> <tr><td>1</td><td>AI0 +</td></tr> <tr><td>2</td><td>AI0 -</td></tr> <tr><td>3</td><td>AI1 +</td></tr> <tr><td>4</td><td>AI1 -</td></tr> <tr><td>5</td><td>AI2 +</td></tr> <tr><td>6</td><td>AI2 -</td></tr> <tr><td>7</td><td>AI3 +</td></tr> <tr><td>8</td><td>AI3 -</td></tr> <tr><td>9</td><td>Mana</td></tr> <tr><td>10</td><td>AUX</td></tr> </tbody> </table>	pin assignment		Terminal	Assignment	1	AI0 +	2	AI0 -	3	AI1 +	4	AI1 -	5	AI2 +	6	AI2 -	7	AI3 +	8	AI3 -	9	Mana	10	AUX	<table border="1"> <thead> <tr> <th colspan="2">pin assignment</th> </tr> <tr> <th>Terminal</th> <th>Assignment</th> </tr> </thead> <tbody> <tr><td>1</td><td>AI0 +</td></tr> <tr><td>2</td><td>AI0 -</td></tr> <tr><td>3</td><td>AI1 +</td></tr> <tr><td>4</td><td>AI1 -</td></tr> <tr><td>5</td><td>AI2 +</td></tr> <tr><td>6</td><td>AI2 -</td></tr> <tr><td>7</td><td>AI3 +</td></tr> <tr><td>8</td><td>AI3 -</td></tr> <tr><td>9</td><td>n.c.</td></tr> <tr><td>10</td><td>AUX</td></tr> </tbody> </table>	pin assignment		Terminal	Assignment	1	AI0 +	2	AI0 -	3	AI1 +	4	AI1 -	5	AI2 +	6	AI2 -	7	AI3 +	8	AI3 -	9	n.c.	10	AUX
	pin assignment																																																	
Terminal	Assignment																																																	
1	AI0 +																																																	
2	AI0 -																																																	
3	AI1 +																																																	
4	AI1 -																																																	
5	AI2 +																																																	
6	AI2 -																																																	
7	AI3 +																																																	
8	AI3 -																																																	
9	Mana																																																	
10	AUX																																																	
pin assignment																																																		
Terminal	Assignment																																																	
1	AI0 +																																																	
2	AI0 -																																																	
3	AI1 +																																																	
4	AI1 -																																																	
5	AI2 +																																																	
6	AI2 -																																																	
7	AI3 +																																																	
8	AI3 -																																																	
9	n.c.																																																	
10	AUX																																																	

Module ordering data

GBS20  
Analog output module

GBS20-4AO-I (0/4~20mA)



0~20mA  
4~20mA  
12Bit

Parameters	
Number of outputs	4
Output range	0~20mA    4~20mA
Backplane isolation	Yes
Channels isolation	No
External current draw	Max.100mA
Internal current draw	Max.26mA
Power dissipation	Max.3W
Actuator connection	2 wire system
Load resistance	Max.600Ω
Inductive load	Max.100mH
No-load voltage	Max.18V
Measurement resolution	12bits
Refresh time	0.2ms
Diagnosis	External reference voltage loss (L+) Break Parameter assignment error
Error range	
Operating error	±0.5%
Basic error	±0.3% @ 25°C
Temperature error	/ K±0.005%
Linear error	/ K±0.05%
Repeatability accuracy	/ K±0.05%
Parameter length	13bytes
Error indicator	Red LED
Hot-pluggable	Yes
Dimensions(HxWxD)	110mm x 14mm x 73mm
Weight	70g
Installation method	Guide rail type
Protection rating	IP20
Ambient temperature	0°C~50°C
Storage temperature	-20°C~80°C
Relative humidity	5 ~ 95%RH ( without condensation )

LED Indicator light	
OK	Blue flash: module are not configured; red / red flash: module failure or configuration change
Channel light	Green: the channel input signal is normal

Pin wiring diagram

Pin assignment  
Wiring diagram

pin assignment	
Terminal	Assignment
1	AO0 +
2	AO0 -
3	AO1 +
4	AO1 -
5	AO2 +
6	AO2 -
7	AO3 +
8	AO3 -
9	GND
10	AUX

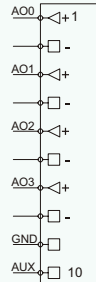

# GBS20 Analog Output Module

GBS20

## Module ordering data

GBS20  
Analog output module

GBS20-4AO-U



0~10V  
1~5V  
±10V  
12Bit

## Parameters

Number of outputs	4		
Output range	0~10V	1~5V	±10V
Backplane isolation	Yes		
Channels isolation	No		
External current draw	Max.75mA		
Internal current draw	Max.24mA		
Power dissipation	Max.2.4W		
Actuator connection	2 wire system		
Load resistance	Min.1000Ω		
Capacitive load	Max.1uF		
Short circuit protection	Yes		
short-circuit current	Max.25mA		
Measurement resolution	12bits + sign		
Refresh time	0.2ms		
Diagnosis	The external reference voltage is lost (L+), and the GSD is short circuited Parameter assignment error		
Error range			
Operating error	±0.5%		
Basic error	±0.3% @ 25°C		
Temperature error	/ K±0.005%		
Linear error	/ K±0.05%		
Repeatability accuracy	/ K±0.05%		
Parameter length	13bytes		
Error indicator	Red LED		
Hot-pluggable	Yes		
Dimensions(HxWxD)	110mm x 14mm x 73mm		
Weight	70g		
Installation method	Guide rail type		
Protection rating	IP20		
Ambient temperature	0°C~50°C		
Storage temperature	-20°C~80°C		
Relative humidity	5 ~ 95%RH ( without condensation )		

## LED Indicator light

OK	Blue flash: module are not configured; red / red flash: module failure or configuration change
Channel light	Green: the channel input signal is normal

## Pin wiring diagram

Pin assignment  
Wiring diagram

pin assignment	
Terminal	Assignment
1	AO0 +
2	AO0 -
3	AO1 +
4	AO1 -
5	AO2 +
6	AO2 -
7	AO3 +
8	AO3 -
9	GND
10	AUX

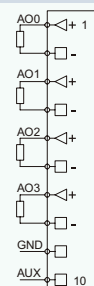

Module ordering data	
GBS20 1 channel high speed counter	GBS20-1CNT-5VDC 
	5V ( RS422 ) 4 MHz 32 bits

Parameters	
Number of counter	1
Count bit length	32 bits
Input frequency	Max. 1 MHz
Counting frequency	Max. 4 MHz
Input voltage	5 VDC , RS422
Backplane isolation	Yes
Sensor supply	5 V±10% , 190mA
Current loss	
-External	50 mA
-Internal	86 mA
Power waste	1 W
Parameter configuration length	15 bytes
Hot-pluggable	Yes
Dimensions(HxWxD)	110mm x 14mm x73mm
Weight	70g
Authentication	CE
Relative humidity	5 ~ 95%RH ( without condensation )
Ambient temperature	0°C~50°C
Storage temperature	-20°C~80°C

LED Indicator light	
OK	Blue flash: module are not configured; red / red flash: module failure or configuration change
Channel light	Green: the channel input signal is normal

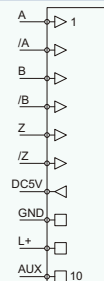
Pin wiring diagram																									
Pin assignment Wiring diagram	<table border="1" style="display: inline-table; margin-right: 20px;"> <thead> <tr> <th colspan="2">pin assignment</th> </tr> <tr> <th>Terminal</th> <th>Assignment</th> </tr> </thead> <tbody> <tr><td>1</td><td>A</td></tr> <tr><td>2</td><td>/A</td></tr> <tr><td>3</td><td>B</td></tr> <tr><td>4</td><td>/B</td></tr> <tr><td>5</td><td>Z</td></tr> <tr><td>6</td><td>/Z</td></tr> <tr><td>7</td><td>5 VDC</td></tr> <tr><td>8</td><td>GND</td></tr> <tr><td>9</td><td>L+, 24 VDC</td></tr> <tr><td>10</td><td>AUX</td></tr> </tbody> </table> 	pin assignment		Terminal	Assignment	1	A	2	/A	3	B	4	/B	5	Z	6	/Z	7	5 VDC	8	GND	9	L+, 24 VDC	10	AUX
pin assignment																									
Terminal	Assignment																								
1	A																								
2	/A																								
3	B																								
4	/B																								
5	Z																								
6	/Z																								
7	5 VDC																								
8	GND																								
9	L+, 24 VDC																								
10	AUX																								

# GBS20 Function Module

GBS20

## Module ordering data

GBS20  
1 channel high speed counter

GBS20-1CNT-24VDC



1 x counter 24V  
500 kHz  
32 Bit

## Parameters

Number of counter	1
Count bit length	32 bit
Input frequency	Max. 125kHz
Counting frequency	Max.500kHz
Input voltage	24VDC
Backplane isolation	Yes
Electrically isolated of input and output	No
Current loss	
-External	10 mA + load
-Internal	Max. 86 mA
Power waste	0.8W
Input characteristic curve	Type 2 , EN 61131-2
Output current	
-Rated	500mA
-Leakage current	Max. 0.5 mA
Short circuit protection	Yes
Parameter configuration length	16 bytes
Hot-pluggable	Yes
Dimensions(HxWxD)	110 mm x 14 mm x 73 mm
Weight	70g
Authentication	CE
Relative humidity	5 ~ 95%RH ( without condensation )
Ambient temperature	0°C~50°C
Storage temperature	-20°C~80°C

## LED Indicator light

OK	Blue flash: module are not configured; red / red flash: module failure or configuration change
Channel light	Green: the channel input signal is normal

## Pin wiring diagram

Pin assignment  
Wiring diagram

pin assignment	
Terminal	Assignment
1	A
2	B
3	Input 0
4	Output 0
5	GND
6	GND
7	GND
8	L+, 24 VDC
9	L+, 24 VDC
10	AUX

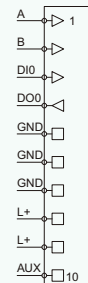

Module ordering data

GBS20  
1 channel SSI communication interface

GBS20-1SSI



Parameters

SSI channel number	1
Supported data bits	13~31 bits
Parity check	None,even,odd
Gray - binary internal conversion	Configurable
Direction detection	Yes
Directional reversal	Configurable
Encoder value to zero	Configurable
Encoder value lock function	It can be triggered by 24V input
Module power supply for encoder	24V DC , 100 mA , fused
Bus backplane electrical isolation	Yes
Diagnosis	Broken line / frame error 24V encoder power supply error Parameter assignment erro
Current loss	
-External	Max. 20 mA + load when the encoder 24V power supply ( max. 100 mA )
-Inside	Max. 130 mA
power loss	Max. 1.0 W
Input characteristic curve	Type 2, EN 61131-2
Output current	
-Rated	500 mA
-Leakage current	Max. 0.5 mA
Short circuit protection	Yes
Parameter configuration length	10 bytes
Hot-pluggable	Yes
Dimensions(HxWxD)	110mm x 14mm x 73mm
Weight	75g
Installation method	Guide rail type
Protection rating	IP20
Relative humidity	5 ~ 95%RH ( without condensation )
Ambient temperature	0°C~50°C
Storage temperature	-20°C~80°C

LED Indicator light

OK	Blue flash: module are not configured; red / red flash: module failure or configuration change
Channel light	Green: the channel input signal is normal

Pin wiring diagram

Pin assignment Wiring diagram	<table border="1"> <thead> <tr> <th colspan="2">pin assignment</th> </tr> <tr> <th>Terminal</th> <th>Assignment</th> </tr> </thead> <tbody> <tr><td>1</td><td>C0+</td></tr> <tr><td>2</td><td>C0-</td></tr> <tr><td>3</td><td>D0+</td></tr> <tr><td>4</td><td>D0-</td></tr> <tr><td>5</td><td>D10</td></tr> <tr><td>6</td><td>GND</td></tr> <tr><td>7</td><td>GND</td></tr> <tr><td>8</td><td>L+, 24 VDC</td></tr> <tr><td>9</td><td>L+, 24 VDC</td></tr> <tr><td>10</td><td>AUX</td></tr> </tbody> </table>	pin assignment		Terminal	Assignment	1	C0+	2	C0-	3	D0+	4	D0-	5	D10	6	GND	7	GND	8	L+, 24 VDC	9	L+, 24 VDC	10	AUX	
	pin assignment																									
Terminal	Assignment																									
1	C0+																									
2	C0-																									
3	D0+																									
4	D0-																									
5	D10																									
6	GND																									
7	GND																									
8	L+, 24 VDC																									
9	L+, 24 VDC																									
10	AUX																									



# GBS20 Function Module

GBS20

## Module ordering data

GBS20  
1 channel RS232/RS422/RS485  
communication interface selectable  
(select in software)

GBS20-1RS232



## Parameters

Agreement	ASCLL , 3964R
Physical layer	RS-232
Baud rate	110 , 300 , 600 , 1,200 , 4,800 , 9,600 , 14,400 , 19,200 , 38,400 , 57,600 , 76,800 , 115,200 baud
Connect	9-pin D-sub
Data bits	7 data bits / 8 data bits
Stop bit	1 stop bits / 2 stop bits
Parity check	No / parity check / odd checksum / custom
ASCII frame end detection	Stop bit, number of characters, internal character delay (1-65535 MS)
Block checking 3964 ( R )	Configurable
Frame length	1-244 characters
Diagnosis	Break Low limit / high limit Module internal error Parameter configuration error Error message
USB interface	
-Protocol	USB 2.0 device
-Connection	Mini-USB
Electrical isolation	Yes
Insulation voltage	1.5 kV
Current loss	
-External	Max. 0 mA
-Inside	Max. 130mA
Power waste	Max. 0.7W
Hot-pluggable	Yes
Dimensions(HxWxD)	110mm x 14mm x 73mm
Weight	70g
Protection rating	IP20
Relative humidity	5 ~ 95%RH ( without condensation )
Ambient temperature	0°C~50°C
Storage temperature	-20°C~80°C

## LED Indicator light

OK	Blue flash: module are not configured; red / red flash: module failure or configuration change
Channel light	Green: the channel input signal is normal

## Pin wiring diagram

Pin assignment  
Wiring diagram

pin assignment	
Terminal	Assignment
1	DCD
2	RxD
3	TxD
4	DTR
5	GND
6	DSR
7	RTS
8	CTS
9	RI

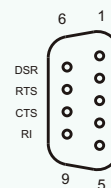

Module ordering data

GBS20  
Three phase power loop detection

GBS20-EMR-5A



GBS20

Parameters

Number of input channels	A,B,C,N Voltage ; A,B,C Current
Voltage	Max. 400 VAC
Maximum secondary current	5A
Bus backplane isolation	Yse
Diagnosis	Overvoltage / undervoltage Flow Zero crossing phase shift
Parameter configuration length	32 bytes
Universal error indication	Red LED
Current loss	Max. 150 mA
Power waste	Max. 2.0 W
Hot-pluggable	Yes
Dimensions(HxWxD)	110mm x 14mm x73mm
Weight	120g
Authentication	CE
Relative humidity	5 ~ 95%RH ( without condensation )
Ambient temperature	0°C~50°C
Storage temperature	-20°C~80°C

LED Indicator light

OK	Blue flash: module are not configured; red / red flash: module failure or configuration change
Channel light	Green: the channel input signal is normal

Pin wiring diagram

Pin assignment  
Wiring diagram

pin assignment			
Terminal	Assignment	Terminal	Assignment
1	U 1	11	I 1 +
2	U 2	12	I 1 -
3	U 3	13	I 2 +
4	N	14	I 2 -
5	n.c.	15	I 3 +
6	n.c.	16	I 3 -
7	n.c.	17	n.c.
8	n.c.	18	n.c.
9	n.c.	19	n.c.
10	AUX	20	AUX

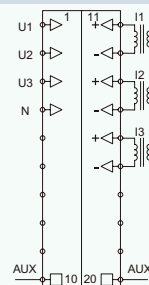

# GBS20 Power Module

GBS20

## Module ordering data

GBS20  
24VDC system power / load power module

GBS20-BR



## Parameters

Voltage	24VDC
Bus backplane electrical isolation	NO
Current loss	
-External	Max. 10 mA+load
-Internal	Max. 35 mA
24VDC power supply	18~30 VDC
Rated input current	Max. 8A , Overcurrent protection device
Reverse polarity protection	Up to 60 V , Electronic
Power loss	Max. 0.7 W
Load	
Total load capacity	8 A
General error indication	Red LED
Hot-pluggable	NO
Dimensions(HxWxD)	110mm x 14mm x73mm
Weight	70g
Authentication	CE
Relative humidity	5 ~ 95%RH ( without condensation )
Ambient temperature	0°C~50°C
Storage temperature	-20°C~80°C

## LED Indicator light

OK	Blue flash: module are not configured; red / red flash: module failure or configuration change
Channel light	Green: the channel input signal is normal

## Pin wiring diagram

Pin assignment  
Wiring diagram

pin assignment	
Terminal	Assignment
1	24 VDC IN
2	GND IN
3	-
4	L+, 24 VDC
5	L+, 24 VDC
6	GND
7	GND
8	-
9	L+, 24 VDC
10	AUX

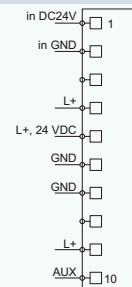

Module ordering data

GBS20  
24VDC load power module

GBS20-PF



Parameters	
Voltage	24VDC
Bus backplane electrical isolation	Yes
Current loss	
-External	Max. 22 mA
-Internal	Max. 5 mA
Power loss	Max. 0.3 W
Load	
Total load capacity	8 A
Hot-pluggable	Yes
Dimensions(HxWxD)	110mm x 14mm x73mm
Weight	70g
Authentication	CE
Relative humidity	5 ~ 95%RH ( without condensation )
Ambient temperature	0°C~50°C
Storage temperature	-20°C~80°C

LED Indicator light	
OK	Blue flash: module are not configured; red / red flash: module failure or configuration change
Channel light	Green: the channel input signal is normal

Pin wiring diagram

Pin assignment  
Wiring diagram

pin assignment	
Terminal	Assignment
1	L+, 24 VDC
2	L+, 24 VDC
3	L+, 24 VDC
4	L+, 24 VDC
5	GND
6	GND
7	GND
8	GND
9	AUX
10	AUX

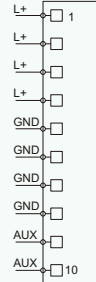



Transmission speed	Communication distance max.
9.6 kbps	1000 m
19.2 kbps	1000 m
45.45 kbps	1000 m
93.75 kbps	1000 m
187.5 kbps	1000 m
500 kbps	400 m
1.5 Mbps	200 m
3 Mbps	100 m
6 Mbps	100 m
12 Mbps	100 m

- Star network settings
- The system can be extended to two, four, six sections of the network
- Optimize network cabling and simplify network structure
- Can be used for bus extensions or as a branch line
- It can also be used in MPI networks
- LED indication of each segment independent state
- Electrical isolation between network segments

Technical specifications / Order data			
PROFIBUS-DP Repeater	HREP20-DP	HREP20-DP/4W	HREP20-DP/6W
Number of connected segments	2-way	4-way	6-way
Dimension(D x W x H)	35mm x 51mm x 72mm	35mm x 94mm x 72mm	35mm x 137mm x 72mm
Weight	About. 110 g	About. 180 g	About. 275 g
Working voltage	18 ~ 30 VDC	18 ~ 30 VDC	18 ~ 30 VDC
Output voltage	5 V	5 V, 150 mA / Segment	5 V, 150 mA / Segment
Electrical isolation	500 V	500 V	500 V
Current consumption Max.	60 mA	280 mA	400 mA
Segment connection	Connect through PROFIBUS	Connect through PROFIBUS	Connect through PROFIBUS
PROFIBUS interface			
Transmission rate Max.	12 Mbps Automatic detection	12 Mbps Automatic detection	12 Mbps Automatic detection
Agreement	PROFIBUS-DP EN 61 158-2	PROFIBUS-DP EN 61 158-2	PROFIBUS-DP EN 61 158-2
working temperature	0 °C ~ +60 °C	0 °C ~ +60 °C	0 °C ~ +60 °C
Storage temperature	-25 °C ~ +75 °C	-25 °C ~ +75 °C	-25 °C ~ +75 °C
Protection grade	IP 20	IP 20	IP 20

PROFIBUS-DP Connector	Order type	Performance and parameter
	HD9T HD9T-P	90°, 9-pin, D-sub, male 90°, 9-pin, D-sub, male, with programming
	HD9T-E HD9T-EP	90°, Needle type quick connection , 9-pin, D-sub, male 90°, Needle type quick connection , 9-pin, D-sub, male, with programming
	HD9T-EDL HD9T-EDLP	90°, Needle type quick connection , 9-pin, D-sub, Diagnosis (LED indication), male 90°, Needle type quick connection , 9-pin, D-sub, Diagnosis (LED indication), male, with programming
	HD9T-PM12	90°, M12 Interface , 9-pin, D-sub, with programming
	HD9T-CR	PROFIBUS Compact repeater, 90°, 9-pin, D-sub, male
	HD9T-BFOC	PROFIBUS Optical link , BFOC interface , 650nm , -7.5 dBm/-20 dBm ( POF 980/1000 μm ) -18 dBm/-22 dBm ( PCF 200/230 μm )
	HNETL-DP/TCP	NETL ink® PRO compact type , , PROFIBUS ethernet gateway , SUB-D/9-pin interface ( DP/MPI/PPI ) , 3 LED ( It contains a tricolor LED ) state indication

CAN BUS Connector	Order type	Performance and parameter
	HC9T HC9T-C	CAN BUS 90°, 9-pin, D-sub, male CAN BUS 90°, 9-pin, D-sub, male, extension port with equipment



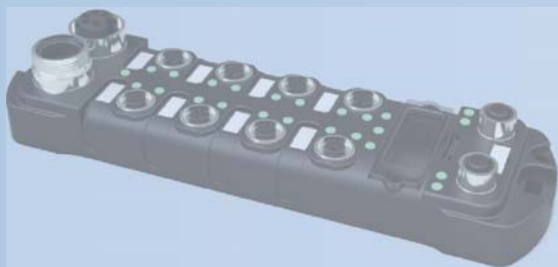
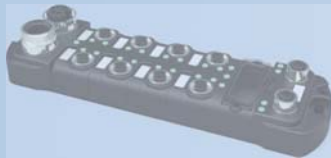

# GX Series IP67 Compact Modules B



■ Features

- Protection degree upto IP67- ensures most successful application on-site
- Fully sealed design- gives excellent vibration resistance feature
- Smart and compact housing- makes installation much more easier



■ Communication

- Support for multiple open bus protocol
- IP67 connector design, safety and reliability
- High integration communication kernel, high-speed & stability

**DI**



**DO**



■ Signal

- Support various kinds of signals
- Various signal combination function, suitable for complex signal transmission requirements
- Configurable modules for Input/Output

GX

**DIO**



■ Connection

- Perfect connectors product line ensures
- Pre-moulding - T type - Field wirable connectors
- Various kinds of connectors, fully satisfy your different requirements



GX series modules type codes

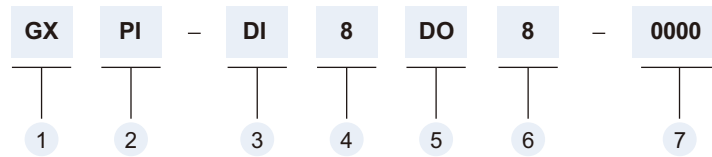

- 1 Product series
- 2 Communication protocol  
 DP: PROFIBUS-DP  
 DN: DeviceNET  
 PI: PROFINET  
 EN: MODBUS-TCP/IP  
 EI: EtherNET/IP  
 EC: EtherCAT
- 3 Signal types  
 DI: Digital input  
 DO: Digital output  
 DIO: DI/DO configured

- 4 Number of channels  
 8: 8 channels  
 16: 16 channels
- 5 Signal types  
 DI: Digital input  
 DO: Digital output  
 DIO: DI/DO configured
- 6 Number of channels  
 8: 8 channels  
 16: 16 channels

- 7 Special codes
  - ① 0 : PNP  
 1 : NPN  
 4 : PNP  
 (Power connector: 4PIN,  
 Except the DeviceNet protocol)
  - 5 : NPN  
 (Power connector: 4PIN,  
 Except the DeviceNet protocol)
  - ② 0: 0.5A  
 1: 2A

GX series module structure

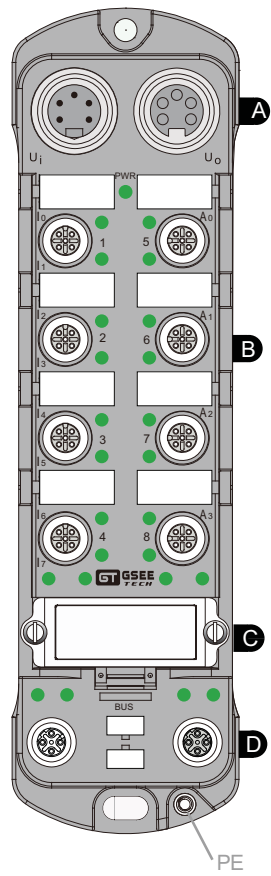

**A The power interface**

- Each module has two 7/8" power supply interface (1 male and female)
- Each power supply interface including the system power supply and load power supply
- Pre-moulding/Field wirable connectors

**B The I/O interface**

- Each module has 8 hole M12 A code I/O interface
- Each M12 interface includes power supply and signal channel
- Pre-moulding/Field wirable connectors

**C Station address dial switch**

- Set the Modules address

**D The bus interface**

- Ethernet modules, each module has 2 M12 D code bus interface (2 male)
- PROFIBUS-DP, each module has 2 M12 B code bus interface (1 male, 1 female)
- DeviceNET, each module has 2 M12 A code bus interface (1 male, 1 female)
- Pre-moulding/Field wirable connectors

GX series modules address distribution and wiring mode

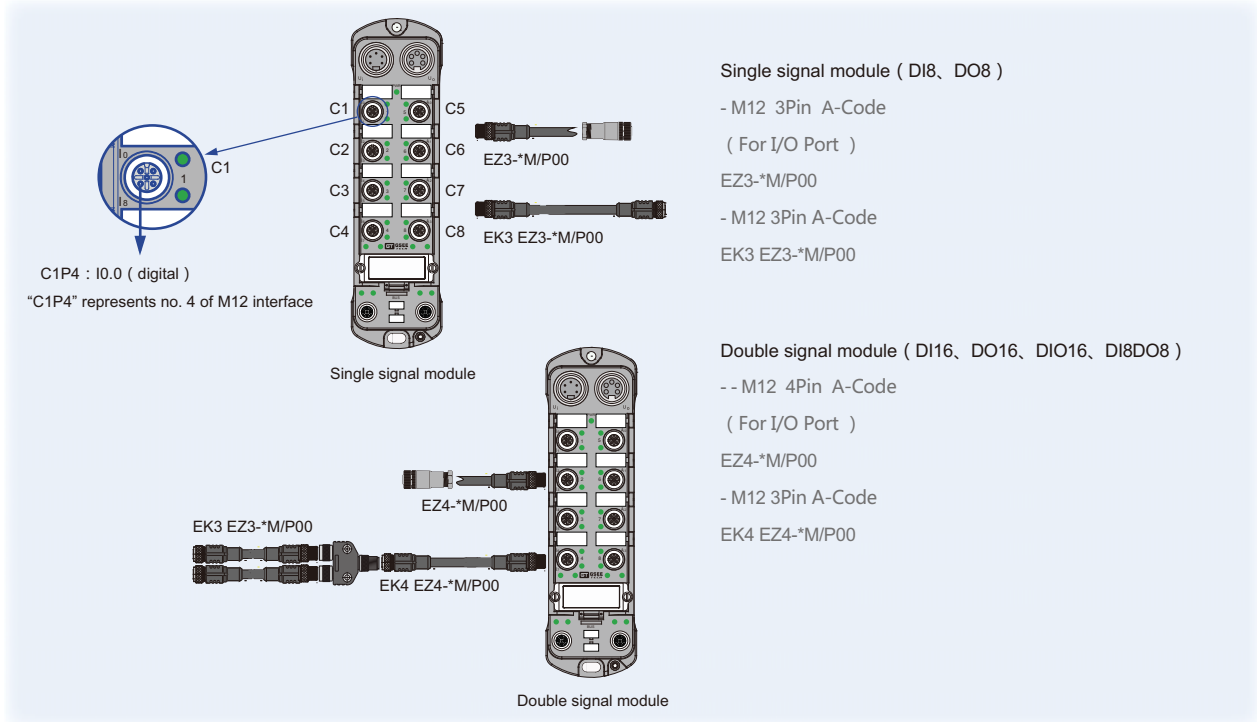

GX

Digital signal address and wiring

M12 x 1 Single signal module ( DI8 )

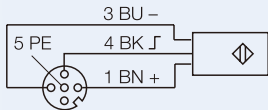

DI8 : C1-C8

M12 x 1 Double signal module(DI16, DI8DO8, DIO16)

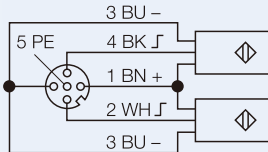

DI16 : C1-C8 ; DI8DO8(Input Part) : C1-C4;  
DIO16(input Part):C1-C8

M12 x 1 Single signal module ( DO8 )

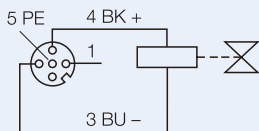

DO8 : C1-C8

M12 x 1 Double signal module(DO16, DI8DO8, DIO16)

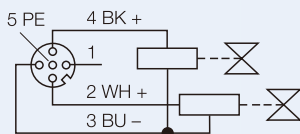

DO16 : C1-C8 ; DI8DO8(Output Part : C1-C4);  
DIO16Output Part:C1-C8

Channel Address	Type	DI8	DI16	DO8	DO16	DI8DO8	DIO16
<b>DI</b>							
bit00		C1P4	C1P4	-	-	C1P4	C1P4
bit01		C2P4	C2P4	-	-	C1P2	C2P4
bit02		C3P4	C3P4	-	-	C2P4	C3P4
bit03		C4P4	C4P4	-	-	C2P2	C4P4
bit04		C5P4	C5P4	-	-	C3P4	C5P4
bit05		C6P4	C6P4	-	-	C3P2	C6P4
bit06		C7P4	C7P4	-	-	C4P4	C7P4
bit07		C8P4	C8P4	-	-	C4P2	C8P4
bit10		-	C1P2	-	-	-	C1P2
bit11		-	C2P2	-	-	-	C2P2
bit12		-	C3P2	-	-	-	C3P2
bit13		-	C4P2	-	-	-	C4P2
bit14		-	C5P2	-	-	-	C5P2
bit15		-	C6P2	-	-	-	C6P2
bit16		-	C7P2	-	-	-	C7P2
bit17		-	C8P2	-	-	-	C8P2
<b>DO</b>							
bit00		-	-	C1P4	C1P4	C5P4	C1P4
bit01		-	-	C2P4	C2P4	C5P2	C2P4
bit02		-	-	C3P4	C3P4	C6P4	C3P4
bit03		-	-	C4P4	C4P4	C6P2	C4P4
bit04		-	-	C5P4	C5P4	C7P4	C5P4
bit05		-	-	C6P4	C6P4	C7P2	C6P4
bit06		-	-	C7P4	C7P4	C8P4	C7P4
bit07		-	-	C8P4	C8P4	C8P2	C8P4
bit10		-	-	-	C1P2	-	C1P2
bit11		-	-	-	C2P2	-	C2P2
bit12		-	-	-	C3P2	-	C3P2
bit13		-	-	-	C4P2	-	C4P2
bit14		-	-	-	C5P2	-	C5P2
bit15		-	-	-	C6P2	-	C6P2
bit16		-	-	-	C7P2	-	C7P2
bit17		-	-	-	C8P2	-	C8P2

- PROFINET I/O Module
- MRP Ring
- System power supply and load power supply independently
- Short circuit, overload, reverse connection protection
- Each channel independent diagnosis, independent protection



## Digital input module

Ordering data	GXPI-DI8-1000	GXPI-DI16-1000	GXPI-DI8	GXPI-DI16
Number of input	8	16	8	16
Connection	M12 , A-coded			
Input				
Input signal	3-wire sensors ,npn , or mes. switches		3-wire sensors ,pnp , or mes. switches	
Input voltage	18...30 VDC			
Operating current	<150 mA , Short circuit protection			
Switching threshold	2 mA/4 mA			
Input delay	2.5 ms			
Switching frequency	≤ 250 Hz			
Max.input current	100 mA			

\* I/O wiring diagram and address distribution refer to B04

## Digital output module

Ordering data	GXPI-DO8	GXPI-DO16	GXPI-DO8-0100
Number of output	8	16	8
Connection	M12 , A-coded		
Output			
Output voltage	18...30 VDC		
Output current /channel	0.5 A , Short circuit protection		2 A , Short circuit protection
Load type	resistive, inductive, lamp load		
Simultaneity factor	1		
Switching frequency	≤ 250 Hz		
Max. output current	0.7A/ch.(Amax=16*0.7A)		2A/ch.(Amax=4*2A)
Electrical isolation	galvanic isolation against the bus		

\* I/O wiring diagram and address distribution refer to B04

## Digital input and output combined module

Ordering data	GXPI-DI8DO8	GXPI-DIO16	GXPI-DI8DO8-0100
Number of input	8	16	8
Number of output	8	16	8
Connection	2 , A-coded		
Input			
Input signal	3-wire sensors ,pnp , or mes. switches		
Input voltage	18...30 VDC		
Operating current	<150 mA , Short circuit protection		
Switching threshold	2 mA/4 mA		
Input delay	2.5 ms		
Switching frequency	≤ 250 Hz		
Max.input current	100 mA		
Output			
Output voltage	18...30 VDC		
Output current /channel	0.5 A , Short circuit protection		2 A , Short circuit protection
Load type	resistive, inductive, lamp load		
Simultaneity factor	1		
Switching frequency	≤ 250 Hz		
Max. output current	0.7A/ch.(Amax=16*0.7A)		2A/ch.(Amax=4*2A)
Electrical isolation	galvanic isolation against the bus		

\* I/O wiring diagram and address distribution refer to B04

Basic Data

PROFINET Interface	
Protocol	PROFINET IO
Connection	7/8" ; 5-Pin ; UB Max.9A , ULMax.9A
Supply voltage	24VDC ( 18...30VDC )
Operating current	< 150 mA
Physical layer	Ethernet
Transmission rate	10/100 Mbps,full duplex
Connection	2 x M12 ( D-Code ) , Integrated switch function
Characteristic	IRT、MRP、LLDP/DCP、PTCP
Alarm function	Diagnose alarm, process alarm, insert connector alarm
Minimum cycle time	250 μsec.
IRT delay	< 3 μsec.
LED-indication	
PWR	Green : OK Red : UL failure
MS	Green : OK Red : Module failure
NS	Green : OK Flashing green : PLC in STOP state Flashing red : IP address not set Off : No connection with PLC
LINK	Quickly flashing green : Ethernet link established,communication present Slowly flashing red : Ethernet link established,no communication present off : No link
I/O	Green : OK Red : I/O fault

U<sub>B</sub>: System Power , U<sub>L</sub>: Load Power  
7/8" Power supply

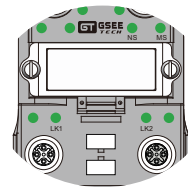
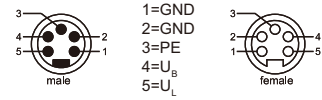

PROFINET Interface PORT1/2

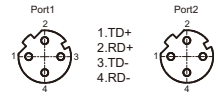

GX

General Data

Protection class	IP67
Operating temperature	-30 ~ 70°C
Storage temperature	-40 ~ 85°C
Relative humidity	5 ~95% without condensation
Application environment	Acc.to EN-61131
Housing material	Glass fiber enhanced nylon(PA6)
Housing colour	Black
Vibration test	Acc.to EN60068-2-6
Impact test	Acc.to EN60068-2-27
Free fall test	Acc.to EN60068-2-32
Electromagnetic compatibility (EMC)	Acc.to EN61000-6-2/EN61000-6-4
Certification	CE
Installation	installation wall mount
Installation hole specification	2个Φ6.3mm
Weight	515g
Dimensions (LxWxH)	226mm x 62mm x 24mm

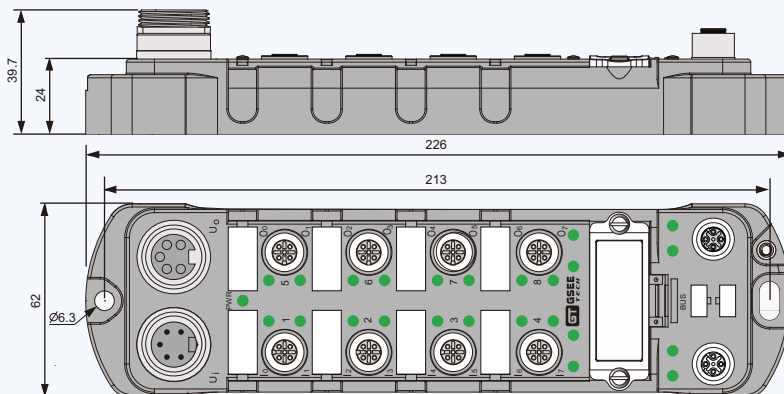

- EtherNET/IP I/O Module
- 2 xm12, 10/100 Mbps, automatic detection
- System power supply and load power supply independently
- Short circuit, overload, reverse connection protection
- Each channel independent diagnosis, independent protection



**EtherNet/IP™**  
conformance tested

#### Digital input module

Ordering data	GXEI-DI8-1000	GXEI-DI16-1000	GXEI-DI8	GXEI-DI16	GXEI-DI16-4000
Number of input	8	16	8	16	16
Connection	M12 , A-coded				
Input					
Input signal	3-wire sensors ,npn , or mes. switches		3-wire sensors ,pnp , or mes. switches		
Input voltage	18...30 VDC				
Operating current	<150 mA , Short circuit protection				
Switching threshold	2 mA/4 mA				
Input delay	2.5 ms				
Switching frequency	≤ 250 Hz				
Max.input current	100 mA				

\* I/O wiring diagram and address distribution refer to B04

#### Digital output module

Ordering data	GXEI-DO8	GXEI-DO16	GXEI-DO16-4000	GXEI-DO8-0100
Number of output	8	16	16	8
Connection	M12 , A-coded			
Output				
Output voltage	18...30 VDC			
Output current /channel	0.5 A , Short circuit protection			2 A , Short circuit protection
Load type	resistive, inductive, lamp load			
Simultaneity factor	1			
Switching frequency	≤ 250 Hz			
Max. output current	0.7A/ch.(Amax=16*0.7A)			2A/ch.(Amax=4*2A)
Electrical isolation	galvanic isolation against the bus			

\* I/O wiring diagram and address distribution refer to B04

#### Digital input and output combined module

Ordering data	GXEI-DI8DO8	GXEI-DI8DO8-4000	GXEI-DIO16	GXEI-DI8DO8-0100
Number of input	8	8	16	8
Number of output	8	8	16	8
Connection	2 , A-coded			
Input				
Input signal	3-wire sensors ,pnp , or mes. switches			
Input voltage	18...30 VDC			
Operating current	<150 mA , Short circuit protection			
Switching threshold	2 mA/4 mA			
Input delay	2.5 ms			
Switching frequency	≤ 250 Hz			
Max.input current	100 mA			
Output				
Output voltage	18...30 VDC			
Output current /channel	0.5 A , Short circuit protection			2A,Short circuit protection
Load type	resistive, inductive, lamp load			
Simultaneity factor	1			
Switching frequency	≤ 250 Hz			
Max. output current	0.7A/ch.(Amax=16*0.7A)			2A/ch.(Amax=4*2A)
Electrical isolation	galvanic isolation against the bus			

\* I/O wiring diagram and address distribution refer to B04

Product specification

Ethernet/IP Interface	
Protocol	ETHERNET/IP
Connection	7/8"; 5-Pin or 4-Pin; UB max. 9 A, UL max. 9 A
Supply voltage	24VDC (18...30V)
Operating current	< 150 mA
Physical layer	EtherNet
Transmission rate	10/100 Mbps, Automatic detection
Connection	2 x M12 (D-coded) , Integrated switch function
transmission protocol	CIP Class 1 or 3
IP address	Through software Settings or the code switch
DHCP	Through the code switch
LED - indication	
PWR	Green: OK Red: UL failure
NS	OFF: No power or no IP address
	Green: Online, one or more connections established (CIP Class 1 or 3)
	Green, flashing: Online, no connections established
	Red: Duplicate IP address, FATAL error
MS	Red, flashing: One or more connections timed out (CIP Class 1 or 3)
	OFF: No power
	Green: Controlled by a Scanner in Run state
	Green, flashing: Not configured, or Scanner in Idle state
LINK	Red: Major fault (EXCEPTION-state, FATAL error etc.)
	Red, flashing: stored parameters differ from currently used parameters.
	OFF: No link, no activity
	Green/Yellow: Link (100 Mbit/s) /Link (10 Mbit/s) established
I/O	Green/Yellow,flashing: Activity (100 Mbit/s)/(10 Mbit/s)
	Green: OK
	Red: I/O fault

\*Note :  $U_B$ :System power ,  $U_L$ :Load power

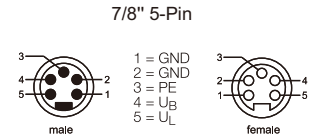

\*Note :  $U_B$ :System power ,  $U_L$ :Load power(-4000)

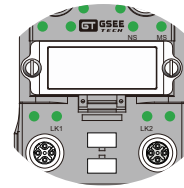
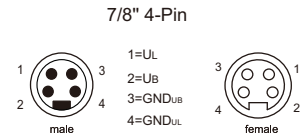

EtherNet/IP PORT1/2

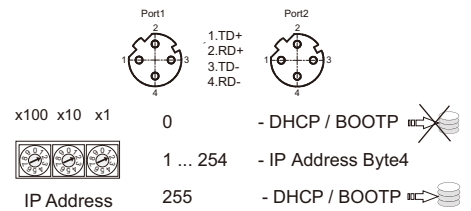

General Data

Protection class	IP67
Operating temperature	-30 ~ 70°C
Storage temperature	-40 ~ 85°C
Relative humidity	5 ~95% without condensation
Application environment	Acc.to EN-61131
Housing material	Glass fiber enhanced nylon(PA6)
Housing colour	Black
Vibration test	Acc.to EN60068-2-6
Impact test	Acc.to EN60068-2-27
Free fall test	Acc.to EN60068-2-32
Electromagnetic compatibility (EMC)	Acc.to EN61000-6-2/EN61000-6-4
Certification	CE
Installation	installation wall mount
Installation hole specification	2个Φ6.3mm
Weight	515g
Dimensions (LxWxH)	226mm x 62mm x 24mm

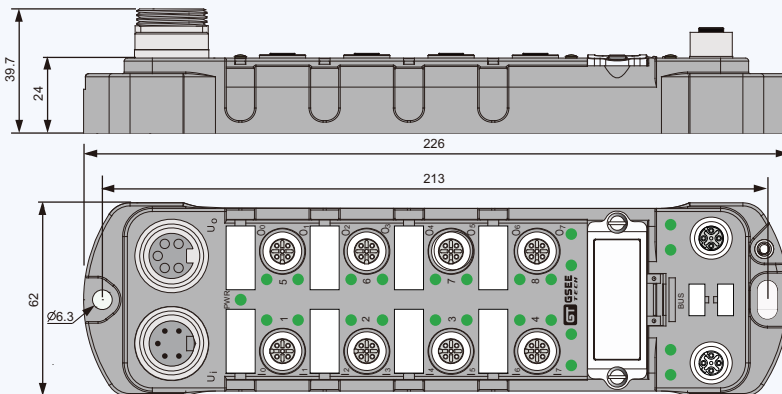



- EtherCAT I/O Module
- 2xM12 , 100BASE-TX , Distributed clock
- System power supply and load power supply independently
- Short circuit, overload, reverse connection protection
- Each channel independent diagnosis, independent protection



Digital input module

Ordering data	GXEC-DI8-1000	GXEC-DI16-1000	GXEC-DI8	GXEC-DI16
Number of input	8	16	8	16
Connection	M12 , A-coded			
Input				
Input signal	3-wire sensors ,nnp , or mes. switches		3-wire sensors ,pnp , or mes. switches	
Input voltage	18...30 VDC			
Operating current	<150 mA , Short circuit protection			
Switching threshold	2 mA/4 mA			
Input delay	2.5 ms			
Switching frequency	≤ 250 Hz			
Max.input current	100 mA			

\* I/O wiring diagram and address distribution refer to B04

Digital output module

Ordering data	GXEC-DO8	GXEC-DO16	GXEC-DO8-0100
Number of output	8	16	8
Connection	M12 , A-coded		
Output			
Output voltage	18...30 VDC		
Output current /channel	0.5 A , Short circuit protection		2 A , Short circuit protection
Load type	resistive, inductive, lamp load		
Simultaneity factor	1		
Switching frequency	≤ 250 Hz		
Max. output current	0.7A/ch.(Amax=16*0.7A)		2A/ch.(Amax=4*2A)
Electrical isolation	galvanic isolation against the bus		

\* I/O wiring diagram and address distribution refer to B04

Digital input and output combined module

Ordering data	GXEC-DI8DO8	GXEC-DIO16
Number of input	8	16
Number of output	8	16
Connection	2 , A-coded	
Input		
Input signal	3-wire sensors ,pnp , or mes. switches	
Input voltage	18...30 VDC	
Operating current	<150 mA , Short circuit protection	
Switching threshold	2 mA/4 mA	
Input delay	2.5 ms	
Switching frequency	≤ 250 Hz	
Max.input current	100 mA	
Output		
Output voltage	18...30 VDC	
Output current /channel	0.5 A , Short circuit protection	
Load type	resistive, inductive, lamp load	
Simultaneity factor	1	
Switching frequency	≤ 250 Hz	
Max. output current	0.7A/ch.(Amax=16*0.7A)	
Electrical isolation	galvanic isolation against the bus	

\* I/O wiring diagram and address distribution refer to B04

Product specification

ETHERCAT Interface	
Protocol	EtherCAT
Connection	7/8" ; 5-Pin ; UB Max.9A , UL Max.9A
Supply voltage	24VDC ( 18...30VDC )
Operating current	< 150 mA
Physical layer	Ethernet
Transmission rate	100 Mbps
Connection	2 x M12 ( D-Code )
Address	Through software Setting
EtherCAT function	Modular description, CoE emergency message, automatic mapping
LED-indication	
PWR	Green: OK Red : UL failure
RUN	Off :INIT state or power source exception Green :OPERATIONAL status Green, blinking :PRE-OPERATIONAL status Green, single flash:SAFT-OPERATIONAL status Flickering:BOOT Status
ERR	Off :NO FAULT Red, blinking : Invalid configuration Red, single flash :Unsolicited state change Red, double flash :Application watchdog timeout: Red :Application controller failure
LINK	Off : No link Flickering: Booting error detected Flashing green:Link normal, communication establishment Green:The link is normal but no communication
I/O	Green: OK Red:Fault

U<sub>B</sub>: System Power , U<sub>L</sub>: Load Power  
7/8" Power supply

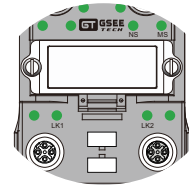
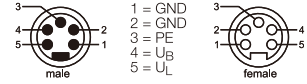

EtherCAT Interface PORT1/2

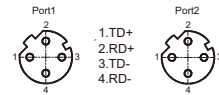

General Data

Protection class	IP67
Operating temperature	-30 ~ 70°C
Storage temperature	-40 ~ 85°C
Relative humidity	5 ~95% without condensation
Application environment	Acc.to EN-61131
Housing material	Glass fiber enhanced nylon(PA6)
Housing colour	Black
Vibration test	Acc.to EN60068-2-6
Impact test	Acc.to EN60068-2-27
Free fall test	Acc.to EN60068-2-32
Electromagnetic compatibility (EMC)	Acc.to EN61000-6-2/EN61000-6-4
Certification	CE
Installation	installation wall mount
Installation hole specification	2个Φ6.3mm
Weight	515g
Dimensions (LxWxH)	226mm x 62mm x 24mm

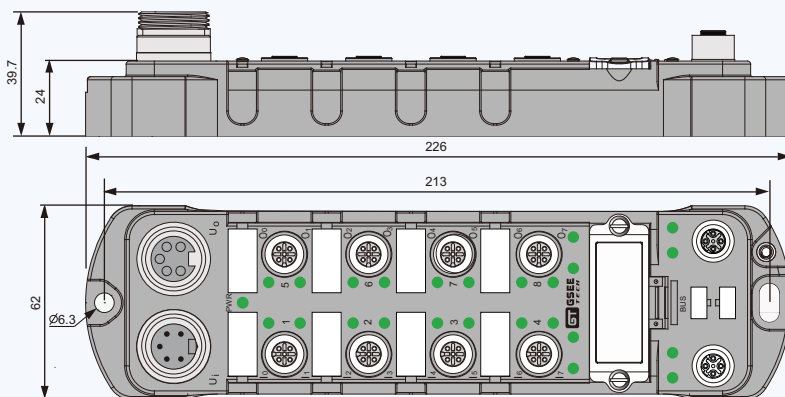

- MODBUS TCP/IP I/O Module
- 2 xM12 , Integrated switch functions
- System power supply and load power supply independently
- Short circuit, overload, reverse connection protection
- Each channel independent diagnosis, independent protection



Digital input module

Ordering data	GXEN-DI8-1000	GXEN-DI16-1000	GXEN-DI8	GXEN-DI16
Number of input	8	16	8	16
Connection	M12 , A-coded			
Input				
Input signal	3-wire sensors ,npn , or mes. switches		3-wire sensors ,pnp , or mes. switches	
Input voltage	18...30 VDC			
Operating current	<150 mA , Short circuit protection			
Switching threshold	2 mA/4 mA			
Input delay	2.5 ms			
Switching frequency	≤ 250 Hz			
Max.input current	100 mA			

\* I/O wiring diagram and address distribution refer to B04

Digital output module

Ordering data	GXEN-DO8	GXEN-DO16	GXEN-DO8-0100
Number of output	8	16	8
Connection	M12 , A-coded		
Output			
Output voltage	18...30 VDC		
Output current /channel	0.5 A , Short circuit protection		2 A , Short circuit protection
Load type	resistive, inductive, lamp load		
Simultaneity factor	1		
Switching frequency	≤ 250 Hz		
Max. output current	0.7A/ch.(Amax=16*0.7A)		2A/ch.(Amax=4*2A)
Electrical isolation	galvanic isolation against the bus		

\* I/O wiring diagram and address distribution refer to B04

Digital input and output combined module

Ordering data	GXEN-DI8DO8	GXEN-DIO16
Number of input	8	16
Number of output	8	16
Connection	2 , A-coded	
Input		
Input signal	3-wire sensors ,pnp , or mes. switches	
Input voltage	18...30 VDC	
Operating current	<150 mA , Short circuit protection	
Switching threshold	2 mA/4 mA	
Input delay	2.5 ms	
Switching frequency	≤ 250 Hz	
Max.input current	100 mA	
Output		
Output voltage	18...30 VDC	
Output current /channel	0.5 A , Short circuit protection	
Load type	resistive, inductive, lamp load	
Simultaneity factor	1	
Switching frequency	≤ 250 Hz	
Max. output current	0.7A/ch.(Amax=16*0.7A)	
Electrical isolation	galvanic isolation against the bus	

\* I/O wiring diagram and address distribution refer to B04

Product specification

Modbus TCP/IP Interface	
Protocol	Modbus TCP/IP
Connection	7/8"; 5-Pin or 4-Pin; UB max. 9 A, UL max. 9 A
Supply voltage	24VDC (18...30V)
Operating current	< 150 mA
Physical layer	EtherNet
Transmission rate	10/100 Mbps, Automatic detection
Connection	2 x M12 (D-coded) , Integrated switch function
Address	Through the code switch
Modbus Function code	1 , 2 , 3 , 4 , 5 , 6 , 15 , 22 , 23
LED- indication	
PWR	Green : OK Red : UL failure
NS	OFF : No IP Address
	Green : Receive at least one MODBUS message
	Green, blinking : Wait for the first MODBUS message
	Red : IP address conflict detected, FATAL ERROR
MS	Red, blinking : Connection timeout
	OFF : System power supply exception
	Green : Normal operation
	Red : Major fault, FATAL ERROR
LINK	Red, blinking : Minor fault
	OFF : No link, no activity
	Green/Yellow : Link (100 Mbit/s) established/Link (10 Mbit/s) established
	Green/Yellow blinking : Activity (100 Mbit/s)/ ( 10 Mbit/s )
I/O	Green : OK
	Red : Fault

U<sub>B</sub>: System Power , U<sub>L</sub>: Load Power

7/8" Power supply

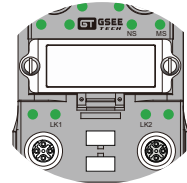
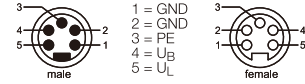

Modbus PORT1/2

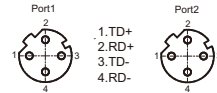

IP Address

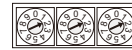

x100 x10 x1

General Data

Protection class	IP67
Operating temperature	-30 ~ 70°C
Storage temperature	-40 ~ 85°C
Relative humidity	5 ~95% without condensation
Application environment	Acc.to EN-61131
Housing material	Glass fiber enhanced nylon(PA6)
Housing colour	Black
Vibration test	Acc.to EN60068-2-6
Impact test	Acc.to EN60068-2-27
Free fall test	Acc.to EN60068-2-32
Electromagnetic compatibility (EMC)	Acc.to EN61000-6-2/EN61000-6-4
Certification	CE
Installation	installation wall mount
Installation hole specification	2个Φ6.3mm
Weight	515g
Dimensions (LxWxH)	226mm x 62mm x 24mm

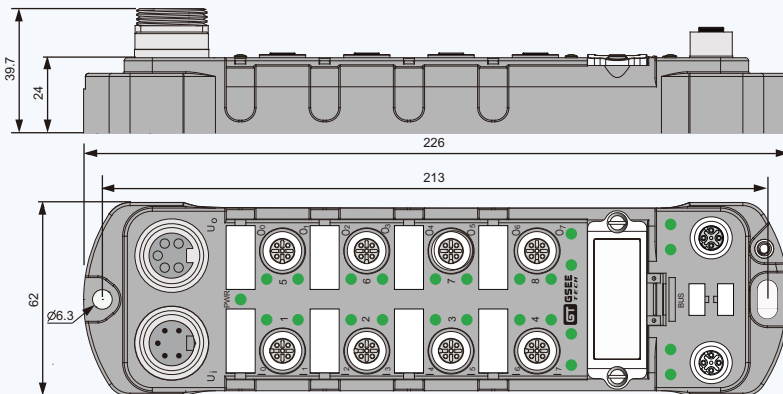

- PROBUS-DP I/O Module
- Support DP-V0
- System power supply and load power supply independently
- Short circuit, overload, reverse connection protection
- Each channel independent diagnosis, independent protection



Digital input module

Ordering data	GXDP-DI8-1000	GXDP-DI16-1000	GXDP-DI8	GXDP-DI16
Number of input	8	16	8	16
Connection	M12 , A-coded			
Input				
Input signal	3-wire sensors ,npn , or mes. switches		3-wire sensors ,pnp , or mes. switches	
Input voltage	18...30 VDC			
Operating current	<150 mA , Short circuit protection			
Switching threshold	2 mA/4 mA			
Input delay	2.5 ms			
Switching frequency	≤ 250 Hz			
Max.input current	100 mA			

\* I/O wiring diagram and address distribution refer to B04

Digital output module

Ordering data	GXDP-DO8	GXDP-DO16	GXDP-DO8-0100
Number of output	8	16	8
Connection	M12 , A-coded		
Output			
Output voltage	18...30 VDC		
Output current /channel	0.5 A , Short circuit protection		2 A , Short circuit protection
Load type	resistive, inductive, lamp load		
Simultaneity factor	1		
Switching frequency	≤ 250 Hz		
Max. output current	0.7A/ch.(Amax=16*0.7A)		2A/ch.(Amax=4*2A)
Electrical isolation	galvanic isolation against the bus		

\* I/O wiring diagram and address distribution refer to B04

Digital input and output combined module

Ordering data	GXDP-DI8DO8	GXDP-DIO16
Number of input	8	16
Number of output	8	16
Connection	2 , A-coded	
Input		
Input signal	3-wire sensors ,pnp , or mes. switches	
Input voltage	18...30 VDC	
Operating current	<150 mA , Short circuit protection	
Switching threshold	2 mA/4 mA	
Input delay	2.5 ms	
Switching frequency	≤ 250 Hz	
Max.input current	100 mA	
Output		
Output voltage	18...30 VDC	
Output current /channel	0.5 A , Short circuit protection	
Load type	resistive, inductive, lamp load	
Simultaneity factor	1	
Switching frequency	≤ 250 Hz	
Max. output current	0.7A/ch.(Amax=16*0.7A)	
Electrical isolation	galvanic isolation against the bus	

\* I/O wiring diagram and address distribution refer to B04

Product specification

PROFIBUS-DP Interface	
Protocol	PROFIBUS DP
Connection	7/8" ; 5-Pin ; UB Max.9A , UL Max.9A
Supply voltage	24VDC ( 18...30VDC )
Operating current	< 150 mA
Physical layer	RS485
Transmission rate	9.6 Kbaud ~ 12 Mbaud
Connection	2 x M12 ( B-Code )
Communication distance	1200M ~ 100M /(according to baud rate)
Address	0 ... 99
LED-indication	
PWR	Green: OK Red : UB failure
ERR	OFF : OK Red : UL failure
BUS	Green : OK Red : PLC stop or communication failure
I/O	Green : OK Red : Fault

U<sub>B</sub>: System Power , U<sub>L</sub>: Load Power  
7/8" Power supply

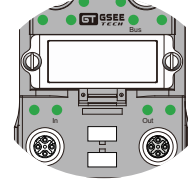
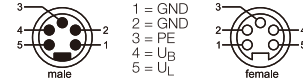

PROFIBUS-DP

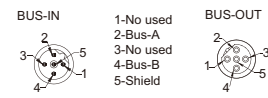

Station address : 0 ... 99



GX

General Data

Protection class	IP67
Operating temperature	-30 ~ 70°C
Storage temperature	-40 ~ 85°C
Relative humidity	5 ~95% without condensation
Application environment	Acc.to EN-61131
Housing material	Glass fiber enhanced nylon(PA6)
Housing colour	Black
Vibration test	Acc.to EN60068-2-6
Impact test	Acc.to EN60068-2-27
Free fall test	Acc.to EN60068-2-32
Electromagnetic compatibility (EMC)	Acc.to EN61000-6-2/EN61000-6-4
Certification	CE
Installation	installation wall mount
Installation hole specification	2∅Φ6.3mm
Weight	515g
Dimensions (LxWxH)	226mm x 62mm x 24mm

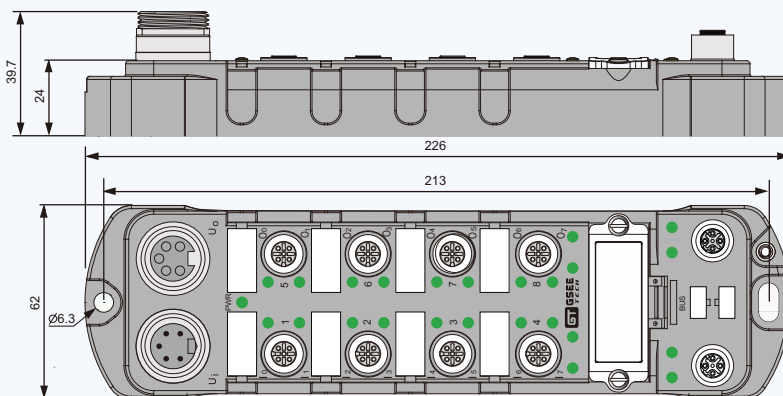

- DeviceNET I/O Module
- Transmission Technology : CAN
- System power supply and load power supply independently
- Short circuit, overload, reverse connection protection
- Each channel independent diagnosis, independent protection



Digital input module

Ordering data	GXDN-DI8-1000	GXDN-DI16-1000	GXDN-DI8	GXDN-DI16
Number of input	8	16	8	16
Connection	M12 , A-coded			
Input				
Input signal	3-wire sensors ,npn , or mes. switches		3-wire sensors ,pnp , or mes. switches	
Input voltage	18...30 VDC			
Operating current	<150 mA , Short circuit protection			
Switching threshold	2 mA/4 mA			
Input delay	2.5 ms			
Switching frequency	≤ 250 Hz			
Max.input current	100 mA			

\* I/O wiring diagram and address distribution refer to B04

Digital output module

Ordering data	GXDN-DO8	GXDN-DO16	GXDN-DO8-0100
Number of output	8	16	8
Connection	M12 , A-coded		
Output			
Output voltage	18...30 VDC		
Output current /channel	0.5 A , Short circuit protection		2 A , Short circuit protection
Load type	resistive, inductive, lamp load		
Simultaneity factor	1		
Switching frequency	≤ 250 Hz		
Max. output current	0.7A/ch.(Amax=16*0.7A)		2A/ch.(Amax=4*2A)
Electrical isolation	galvanic isolation against the bus		

\* I/O wiring diagram and address distribution refer to B04

Digital input and output combined module

Ordering data	GXDN-DI8DO8	GXDN-DIO16
Number of input	8	16
Number of output	8	16
Connection	2 , A-coded	
Input		
Input signal	3-wire sensors ,pnp , or mes. switches	
Input voltage	18...30 VDC	
Operating current	<150 mA , Short circuit protection	
Switching threshold	2 mA/4 mA	
Input delay	2.5 ms	
Switching frequency	≤ 250 Hz	
Max.input current	100 mA	
Output		
Output voltage	18...30 VDC	
Output current /channel	0.5 A , Short circuit protection	
Load type	resistive, inductive, lamp load	
Simultaneity factor	1	
Switching frequency	≤ 250 Hz	
Max. output current	0.7A/ch.(Amax=16*0.7A)	
Electrical isolation	galvanic isolation against the bus	

\* I/O wiring diagram and address distribution refer to B04

Product specification

DeviceNET Interface	
Protocol	DeviceNET
Connection	7/8" ; 4PIN ; U <sub>L</sub> 最大9A
Supply voltage	24VDC ( 18...30VDC )
Operating current	< 150 mA
Physical layer	CAN
Transmission rate	125/250/500 kbps,Auto
Connection	2 x M12 ( A-Code ) , 5Pin
Address range	0 ... 63
Address set	Rotation switches
Termination resistors	External
LED- indication	
PWR	Green : OK Red : UL failure
NS	OFF : Not online / No network power
	Green : On-line, one or more connections are established
	Green, flashing : Online, but countless links
	Red : Network failure
	Red, flashing : One or more connections timed-out
MS	Alternating Red/Green : self-inspection
	OFF : Not operating
	Green : OK
	Green, flashing : Configuration error
	Red : Module failure (unrecoverable)
I/O	Red, flashing : Module failure (recoverable)
	Alternating Red/Green : self-inspection
	Green : OK
	Red : Fault

General Data

Protection class	IP67
Operating temperature	-30 ~ 70°C
Storage temperature	-40 ~ 85°C
Relative humidity	5 ~ 95% without condensation
Application environment	Acc.to EN-61131
Housing material	Glass fiber enhanced nylon(PA6)
Housing colour	Black
Vibration test	Acc.to EN60068-2-6
Impact test	Acc.to EN60068-2-27
Free fall test	Acc.to EN60068-2-32
Electromagnetic compatibility (EMC)	Acc.to EN61000-6-2/EN61000-6-4
Certification	CE
Installation	installation wall mount
Installation hole specification	2个Φ6.3mm
Weight	515g
Dimensions (LxWxH)	226mm x 62mm x 24mm

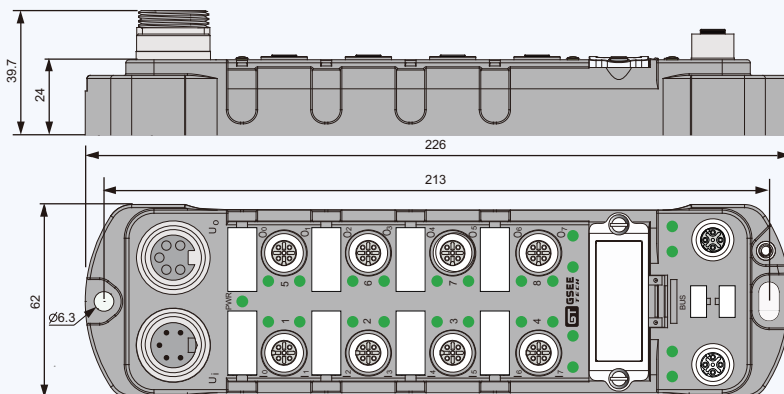

U<sub>L</sub>: Load Power  
7/8" Power supply

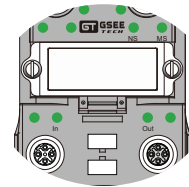
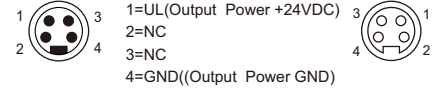

DeviceNet

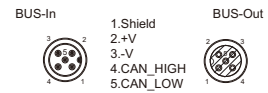

Station Address : 0 ... 64      Communication rate setting







**B.C.E. s.r.l.**  
Via Regina Pacis, 54/c - 41049 SASSUOLO (MO) Italy  
Tel. +39 0536 811.616 r.a. - Fax +39 0536 811.500  
[www.bce.it](http://www.bce.it) - E-mail: [bce@bce.it](mailto:bce@bce.it)



# GXC series IP67 extension module C



**B.C.E. s.r.l.**  
Via Regina Pacis, 54/c - 41049 SASSUOLO (MO) Italy  
Tel. +39 0536 811.616 r.a. - Fax +39 0536 811.500  
www.bce.it - E-mail: bce@bce.it



## Overview of the GXC series

### System overview

GSEE-TECH launched GXC series IP67 protection level scalable industrial field bus system, as an innovative field bus system, this product is more concentrated than traditional. The control mode has higher flexibility. It consists of coupler and expansion module, and coupler supports PROFINET, ETHERNET/IP, MODBUS TCP, EtherCAT, PROFIBUS-DP, DEVICENET and other protocols, the expansion module supports digital, analog, thermal resistance, thermocouple and other signal types. high Performance, modular design, compact structure, durable, high protection level, suitable for a variety of applications.

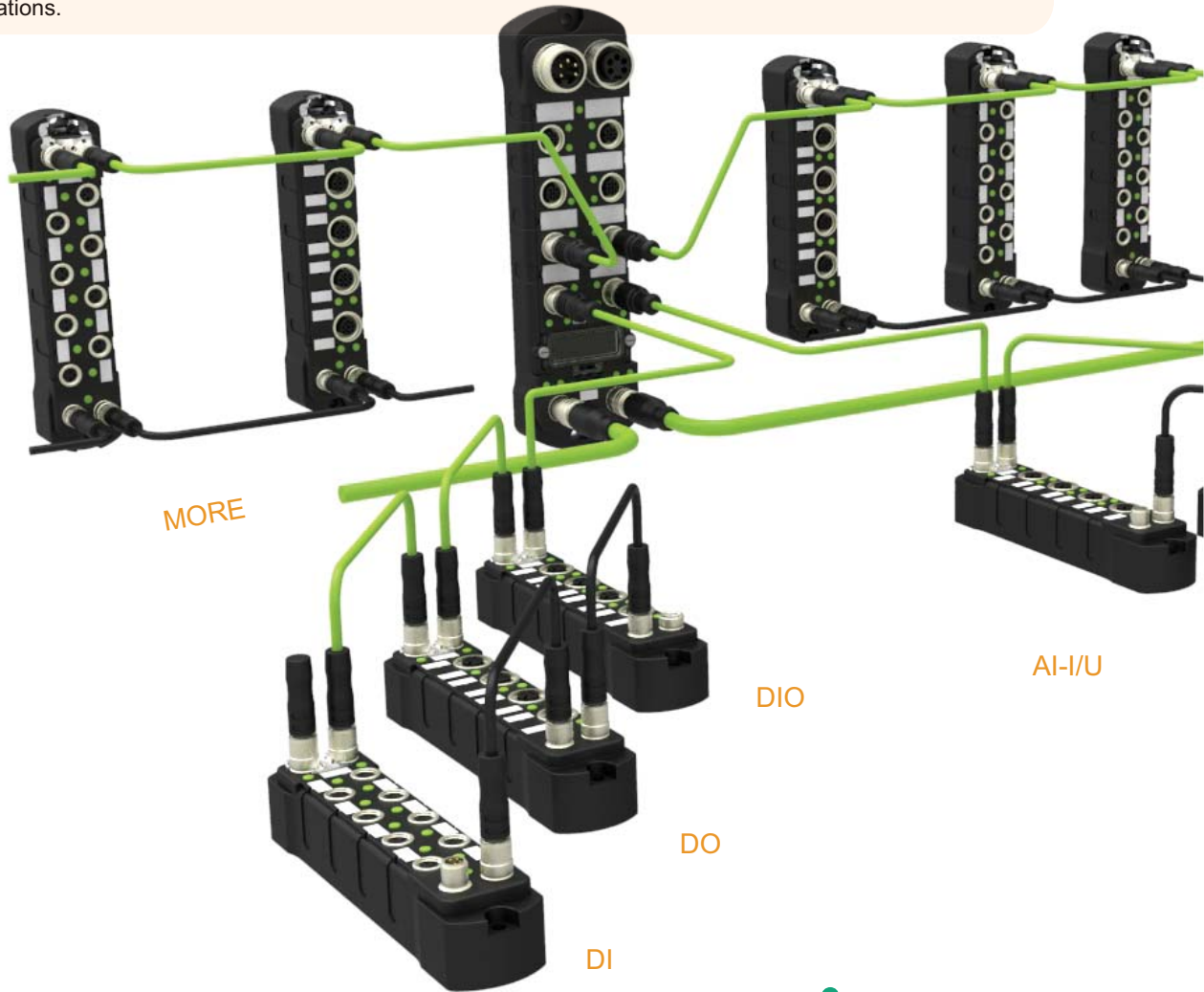

### System Characteristics

- Four branch, can connect more I/O module, up to 32
- The extended distance between modules is 10 meters
- Communication and power isolation
- On line diagnosis of modules and channels
- LED display module and channel state
- Channel protection

**PROFI**  
**NET**

**PROFI**  
**BUS**

**EtherNet/IP™**  
conformance tested

System Composition :

- Coupler: support multiple bus protocols
- Expansion module: support digital input and output, analog input and output
- Subnet expansion cable: connection between coupler and extension module, expansion module and expansion module
- Sub network power cable: power supply for expansion module
- Terminal resistance of subnet



AO-I/U

AI-RTD

AI-TC

Applicable Industry

- Automobile industry
- Metallurgical Industry
- Logistics industry
- Machine tool industry
- New energy industry
- Packaging machinery industry
- Food and beverage industry
- Other automation applications

GXC

EtherCAT®

Modbus

DeviceNet®  
CONFORMANCE TESTED

System advantage

- IP67 high protection level is suitable for various application environments
- Compact design, small size, save space
- More flexible and easy to expand
- Simplify the routing of sensors and actuators
- Reduce the cost of cable
- Save the space in the machine or the control cabinet

## Overview of the GXC series

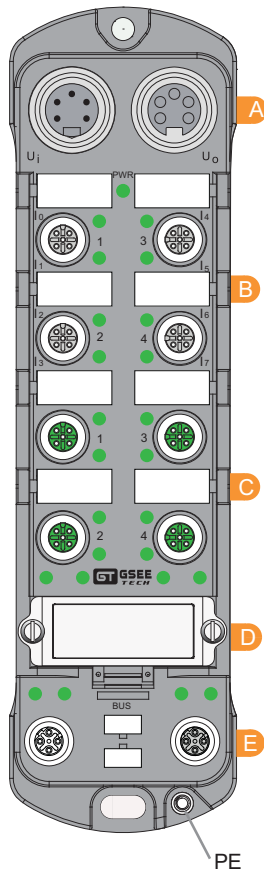

### GXC Coupler port definition

#### A The power interface

- Each module has two 7/8" power supply interface ( 1 male 1 female )
- Each power supply interface including the system power supply and load power supply
- Pre-moulding/Field wirable connectors

#### B I/O interface

- Each module has 8 hole M12 A code I/O interface
- Each M12 interface includes power supply and signal channel
- Pre-moulding/Field wirable connector

#### C extension interface

- each module has four M12 D code extension interfaces
- Each M12 interface includes power supply and signal
- Pre-moulding/Field wirable connector

#### D Station address dial switch

- Set module address (PROFINET no address dialing code)

#### E The bus interface

- Ethernet modules, each module has 2 M12 D code bus interface ( 2 male )
- PROFIBUS-DP, each module has 2 M12 B code bus interface ( 1 male 1 female )
- Devicenet , each module has 2 M12 A code bus interface ( 1 male 1 female )
- Pre-moulding/Field wirable connectors

### GXC Series Coupler size and installation data

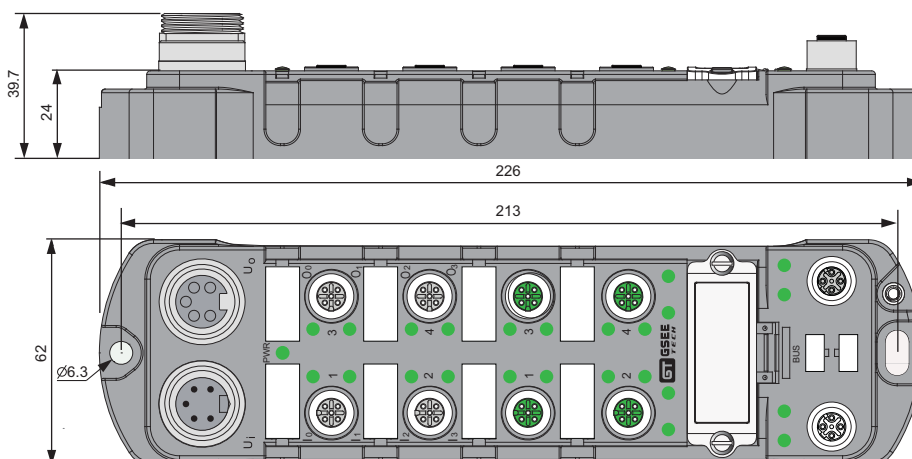

## GXC Series quick selection

Category	Description	Item
Coupler	PROFINET Coupler EtherNET/IP Coupler EtherCAT Coupler Modbus TCP/IP Coupler Profibus-DP Coupler DeviceNET Coupler	GXC-PI GXC-EI GXC-EC GXC-EN GXC-DP GXC-DN
Digital input extension module	DI8, PNP, 4*M12 DI8, NPN, 4*M12 DI8, PNP, 8*M8 DI8, NPN, 8*M8	GXC-DI8 GXC-DI8-N GXC-DI8-M8 GXC-DI8-M8-N
Digital Output extension module	DO8, 0.5A, 4*M12 DO8, 2A, 4*M12 DO8, 0.5A, 8*M8 DO8, 2A, 8*M8	GXC-DO8 GXC-DO8-H GXC-DO8-M8 GXC-DO8-M8-H
Digital input and output extension module	DIO8,PNP,0.5A,4*M12	GXC-DIO8
Analog input extension module	AI4, current , 4*M12 AI4, voltage , 4*M12 AI4, current/voltage , 4*M12 AI4, RTD , 4*M12 AI4, thermocouple , 4*M12	GXC-AI4-I GXC-AI4-U GXC-AI4-I/U GXC-AI4-RTD GXC-AI4-TC
Analog Output extension module	AO4 , current , 4*M12 AO4 , voltage , 4*M12 AO4 , current/voltage , 4*M12	GXC-AO4-I GXC-AO4-U GXC-AO4-I/U

GXC

# GXC PROFINET Coupler

- PROFINET Coupler
- Support 4 extension branch
- Support MRP ring network
- System power supply and load independent
- Protection class IP67



## Basic parameters

Communication Port	
Protocol	PROFINET
Connection	2 x M12 D-code, Integrated switch function
Physical layer	Ethernet
Transmission rate	10/100 Mbps, full duplex
Characteristic	IRT, MRP, LLDP/DCP, PTCIP
Alarm function	Diagnose alarm, process alarm, insert connector alarm
Minimum cycle time	250 µsec.
IRT delay	< 3 µsec.
Power Port	
Connection	2x7/8" ; 5-Pin ; UB Max.9A , ULMax.9A
Supply voltage	24VDC ( 18...30VDC )
Operating current	< 150 mA
Extension port	
Extension protocol	RS485
Connection	4 x M12 A-code
Extended branch structure	4 branch structure
Numbers of extension	Max.32
Communication distance	max. distance between the extension modules is 10m
I/O Channel	
Input/Output Channel	8 channel, 8DIO(self-adaption)
Connection	4 x M12 A-coding
Input signal	3-wire sensors ,npn , or mes. switches 18...30 VDC <150 mA , Short circuit protection
Output signal	18...30 VDC 0.5 A , Short circuit protection
LED-indication	
PWR	Green : OK ; Red : UL failure
MS	Green : OK ; Red : Module failure
NS	Green : OK Flashing green : PLC in STOP state Flashing red : IP address not set Off : No connection with PLC
LINK	Quickly flashing GN : Ethernet link established, communication Slowly flashing RD : Ethernet link established, no communication off : No link
I/O	Green : OK ; Red : I/O Fault
RS485	Green : OK ; Red : Extended branch Fault
Order Information	
Type	GXC-PI
Communication protocol	PROFINET Coupler
Product description	IP67 , Operating temperature:-30~70°C , 226(D)x62(W)x24(H)mm

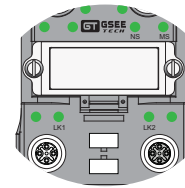

PROFINET Port 1/2

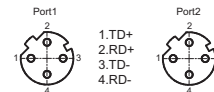

U<sub>B</sub>: System Power , U<sub>L</sub>: Load Power

7/8" Power supply

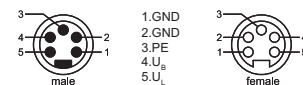

RS485 Extension Port 1/2/3/4

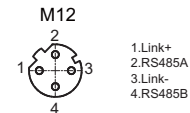

I/O address distribution table

Byte	Bit0	Bit1	Bit2	Bit3	Bit4	Bit5	Bit6	Bit7
0	C1P4	C1P2	C2P4	C2P2	C3P4	C3P2	C4P4	C4P2

I/O port 8DIO(self-adaption) M12 x 1 Input Part

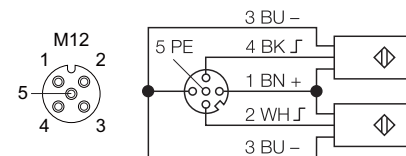

I/O port 8DIO(self-adaption) M12 x 1 Output Part

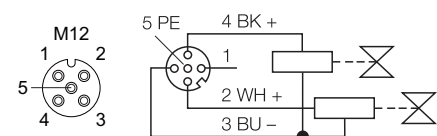

- EtherNET/IP Coupler
- Support 4 extension branch
- 2xM12, 10/100 Mbps, Automatic detection
- System power supply and load independent
- Protection class IP67



**EtherNet/IP™**  
conformance tested

## Basic parameters

Communication Port	
Protocol	EtherNET/IP
Connection	2 x M12 D-code, Integrated switch function
Physical layer	Ethernet
Transmission rate	10/100Mbps, full duplex
Protocol transfer model	CIP Class 1 or 3
IP address	Through the code switch
Power Port	
Connection	2x7/8" ; 5-Pin ; UB Max.9A , ULMax.9A
Supply voltage	24VDC ( 18...30VDC )
Operating current	< 150 mA
Extension port	
Extension protocol	RS485
Connection	4 x M12 A-code
Extended branch structure	4 branch structure
Numbers of extension	Max.32
Communication distance	max. distance between the extension modules is 10m
I/O Channel	
Input/Output Channel	8 channel, 8DIO(self-adaption)
Connection	4 x M12 A-coding
Input signal	3-wire sensors ,npn , or mes. switches 18...30 VDC <150 mA , Short circuit protection
Output signal	18...30 VDC 0.5 A , Short circuit protection
LED-indication	
PWR	Green: OK ; Red: UL failure
MS	OFF: No power ;Green: Controlled by a Scanner in Run state Green, flashing: Not configured, or Scanner in Idle state Red: Major fault (EXCEPTION-state, FATAL error etc.)
NS	OFF: No power or no IP address Green: Online, one or more connections established (CIP Class 1 or 3) Green, flashing: Online, no connections established
LINK	OFF: No link, no activity Green/Yellow: Link (100 Mbit/s) /Link (10 Mbit/s) established Green/Yellow,flashing: Activity (100 Mbit/s)/(10 Mbit/s)
I/O	Green : OK ; Red : I/O Fault
RS485	Green : OK ; Red : Extended branch Fault
Order Information	
Type	GXC-EI
Communication protocol	Ethernet/IP Coupler
Product description	IP67 , Operating temperature:-30~70°C , 226(D)x62(W)x24(H)mm

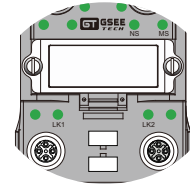

EtherNET/IP Port 1/2

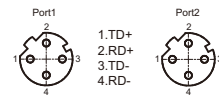

x100 x10 x1	0	- DHCP / BOOTP
	1 ... 254	- IP Address Byte4
IP Address	255	- DHCP / BOOTP

U<sub>B</sub>: System Power , U<sub>L</sub>: Load Power

7/8" Power supply



RS485 Extension Port 1/2/3/4

M12

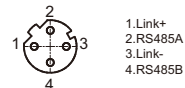

I/O address distribution table

Byte	Bit0	Bit1	Bit2	Bit3	Bit4	Bit5	Bit6	Bit7
0	C1P4	C1P2	C2P4	C2P2	C3P4	C3P2	C4P4	C4P2

I/O port 8DIO(self-adaption) M12 x 1 Input Part

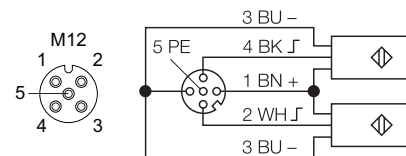

I/O port 8DIO(self-adaption) M12 x 1 Output Part

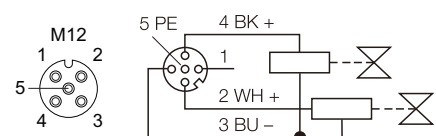



# GXC EtherCAT Coupler

- EtherCAT Coupler
- Support 4 extension branch
- 2xM12 , 100 BASE-TX , Automatic detection
- Distributed clock function
- System power supply and load independent
- Protection class IP67



EtherCAT®

## Basic parameters

Communication Port	
Protocol	EtherCAT
Connection	2 x M12 D-code
Physical layer	Ethernet
Transmission rate	100Mbps
EtherCAT Function	Modular description, CoE emergency message, automatic mapping
IP address	Through software Settings

Power Port	
Connection	2x7/8" ; 5-Pin ; UB Max.9A , ULMax.9A
Supply voltage	24VDC ( 18...30VDC )
Operating current	< 150 mA

Extension port	
Extension protocol	RS485
Connection	4 x M12 A-code
Extended branch structure	4 branch structure
Numbers of extension	Max.32
Communication distance	max. distance between the extension modules is 10m

I/O Channel	
Input/Output Channel	8 channel, 8DIO(self-adaption)
Connection	4 x M12 A-coding
Input signal	3-wire sensors ,npn , or mes. switches 18...30 VDC <150 mA , Short circuit protection
Output signal	18...30 VDC 0.5 A , Short circuit protection

LED-indication	
PWR	Green: OK ; Red : UL failure
RUN	Off :INIT state or power source exception Green :OPERATIONAL status; Green, blinking :PRE-OPERATIONAL status Green, single flash:SAFT-OPERATIONAL status ; Flickering:BOOT Status
ERR	Off :NO FAULT Red, blinking : Invalid configuration; Red, single flash :Unsolicted state change Red, double flash :Application watchdog timeout; Red :Application controller failure
LINK	Off : No link ; Flickering: Booting error detected Flashing green:Link normal, communication establishment Green:The link is normal but no communication
I/O	Green : OK ; Red : I/O Fault
RS485	Green : OK ; Red : Extended branch Fault

Order Information	
Type	GXC-EC
Communication protocol	EtherCATCoupler
Product description	IP67 , Operating temperature:-30~70°C , 226(D)x62(W)x24(H)mm

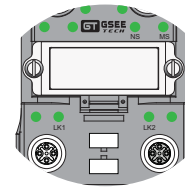

EtherCAT Port 1/2

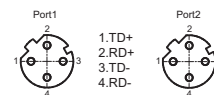

U<sub>B</sub>: System Power , U<sub>L</sub>: Load Power

7/8" Power supply

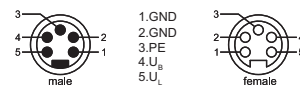

RS485 Extension Port 1/2/3/4

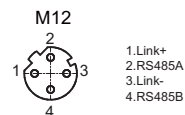

I/O address distribution table

Byte	Bit0	Bit1	Bit2	Bit3	Bit4	Bit5	Bit6	Bit7
0	C1P4	C1P2	C2P4	C2P2	C3P4	C3P2	C4P4	C4P2

I/O port 8DIO(self-adaption) M12 x 1 Input Part

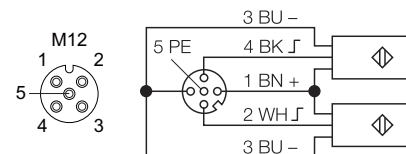

I/O port 8DIO(self-adaption) M12 x 1 Output Part

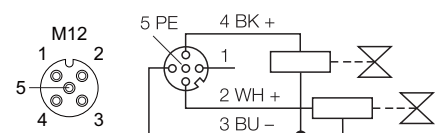

- MODBUS TCP/IP Coupler
- Support 4 extension branch
- 2xM12, 10/100 Mbps, Integrated switch function
- System power supply and load independent
- Protection class IP67



## 基础参数

Communication Port	
Protocol	MODBUS TCP/IP
Connection	2 x M12 D-code, Integrated switch function
Physical layer	Ethernet
Transmission rate	10/100Mbps, full duplex
IP Address	Through the code switch
MODBUS function code	1, 2, 3, 4, 5, 6, 15, 16, 22, 23
Power Port	
Connection	2x7/8" ; 5-Pin ; UB Max.9A , ULMax.9A
Supply voltage	24VDC ( 18...30VDC )
Operating current	< 150 mA
Extension port	
Extension protocol	RS485
Connection	4 x M12 A-code
Extended branch structure	4 branch structure
Numbers of extension	Max.32
Communication distance	max. distance between the extension modules is 10m
I/O Channel	
Input/Output Channel	8 channel, 8DIO(self-adaption)
Connection	4 x M12 A-coding
Input signal	3-wire sensors ,npn , or mes. switches 18...30 VDC <150 mA , Short circuit protection
Output signal	18...30 VDC 0.5 A , Short circuit protection
LED-indication	
PWR	Green : OK ; Red : UL failure
MS	OFF : System power supply exception Green : Normal operation Red : Major fault, FATAL ERROR; Red, blinking : Minor fault
NS	OFF : No IP Address Green : Receive at least one MODBUS message; Red : IP address conflict detected, FATAL ERROR; Red, blinking : Connection timeout
LINK	OFF : No link, no activity Green/Yellow : Link (100 Mbit/s) established/Link (10 Mbit/s) established Green/Yellow blinking : Activity (100 Mbit/s)/ ( 10 Mbit/s )
I/O	Green : OK ; Red : I/O Fault
RS485	Green : OK ; Red : Extended branch Fault
Order Information	
Type	GXC-EN
Communication protocol	MODBUS TCP/IP Coupler
Product description	IP67 , Operating temperature:-30~70°C , 226(D)x62(W)x24(H)mm

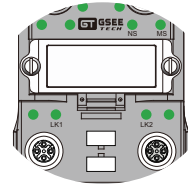

MODBUS TCP/IP Port 1/2

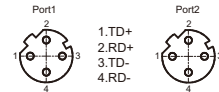

IP Address code switch

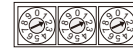

x100 x10 x1

U<sub>B</sub>: System Power , U<sub>L</sub>: Load Power

7/8" Power supply



RS485 Extension Port 1/2/3/4

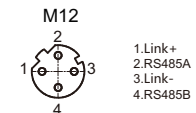

I/O address distribution table

Byte	Bit0	Bit1	Bit2	Bit3	Bit4	Bit5	Bit6	Bit7
0	C1P4	C1P2	C2P4	C2P2	C3P4	C3P2	C4P4	C4P2

I/O port 8DIO(self-adaption) M12 x 1 Input Part

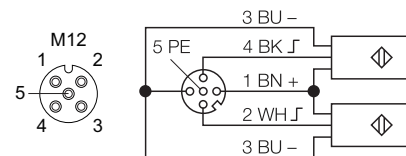

I/O port 8DIO(self-adaption) M12 x 1 Output Part

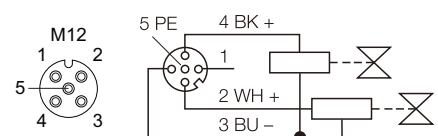

# GXC PROFIBUS-DP Coupler

- PROFIBUS-DP Coupler
- Support 4 extension branch
- Support DP-V0
- System power supply and load independent
- Protection class IP67



## Basic parameters

Communication Port	
Protocol	PROFIBUS-DP
Connection	2 x M12 B-code
Physical layer	RS485
Transmission rate	9.6 Kbaud ~ 12 Mbaud ,
Communication distance	1200M ~ 100M /(according to baud rate)
Address	0 ... 99
Address setting	2 x Decimal rotation switch
Power Port	
Connection	2x7/8" ; 5-Pin ; UB Max.9A , ULMax.9A
Supply voltage	24VDC ( 18...30VDC )
Operating current	< 150 mA

Extension port	
Extension protocol	RS485
Connection	4 x M12 A-code
Extended branch structure	4 branch structure
Numbers of extension	Max.32
Communication distance	max. distance between the extension modules is 10m

I/O Channel	
Input/Output Channel	8 channel, 8DIO(self-adaption)
Connection	4 x M12 A-coding
Input signal	3-wire sensors ,npn , or mes. switches 18...30 VDC
	<150 mA , Short circuit protection
Output signal	18...30 VDC
	0.5 A , Short circuit protection

LED-indication	
PWR	Green: OK ; Red : UB failure
ERR	OFF : OK Red : UL failure
BUS	Green : OK Red : PLC stop or communication failure
I/O	Green : OK Red : I/O Fault
RS485	Green : OK Red : Extended branch Fault

Order Information	
Type	GXC-DP
Communication protocol	PROFIBUS-DP Coupler
Product description	IP67 , Operating temperature:-30~70°C , 226(D)x62(W)x24(H)mm

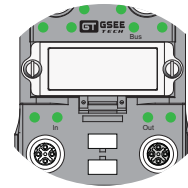

PROFIBUS-DP

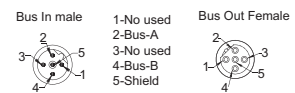

Station Address : 0 ... 99



U<sub>B</sub>: System Power , U<sub>L</sub>: Load Power  
7/8" Power supply

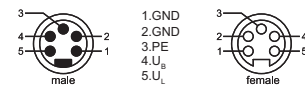

RS485 Extension Port 1/2/3/4

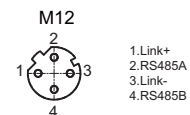

I/O address distribution table

Byte	Bit0	Bit1	Bit2	Bit3	Bit4	Bit5	Bit6	Bit7
0	C1P4	C1P2	C2P4	C2P2	C3P4	C3P2	C4P4	C4P2

I/O port 8DIO(self-adaption) M12 x 1 Input Part

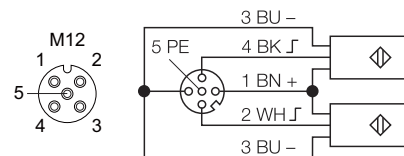

I/O port 8DIO(self-adaption) M12 x 1 Output Part

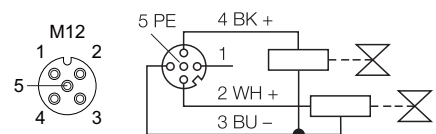

- DeviceNET Coupler
- Support 4 extension branch
- Transmission technology : CAN
- System power supply and load independent
- Protection class IP67



Basic parameters

Communication Port	
Protocol	DeviceNET
Connection	2 x M12 A-code
Physical layer	CAN
Transmission rate	125/250/500 kbps,Auto
Address range	0 ... 63
Address	2 x Decimal rotation switch

Power Port	
Connection	2x7/8" ; 5-Pin ; UB Max.9A , ULMax.9A
Supply voltage	24VDC ( 18...30VDC )
Operating current	< 150 mA

Extension port	
Extension protocol	RS485
Connection	4 x M12 A-code
Extended branch structure	4 branch structure
Numbers of extension	Max.32
Communication distance	max. distance between the extension modules is 10m

I/O Channel	
Input/Output Channel	8 channel, 8DIO(self-adaption)
Connection	4 x M12 A-coding
Input signal	3-wire sensors ,npn , or mes. switches 18...30 VDC <150 mA , Short circuit protection
Output signal	18...30 VDC 0.5 A , Short circuit protection

LED-indication	
PWR	Green : OK ; Red : UL failure
NS	OFF : Not online / No network power;Green : On-line, one or more connections are established;Green, flashing : Online, but countless links Red : Network failure ;Red, flashing : One or more connections timed-out Alternating Red/Green : self-inspection
MS	OFF : Not operating; Green : OK; Green, flashing : Configuration error Red : Module failure (unrecoverable); Alternating Red/Green : self-inspection
I/O	Green : OK ; Red : I/O Fault
RS485	Green : OK ; Red : Extended branch Fault

Order Information	
Type	GXC-DN
Communication protocol	DeciceNET Coupler
Product description	IP67 , Operating temperature:-30~70°C , 226(D)x62(W)x24(H)mm

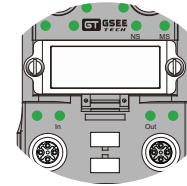

DeviceNet

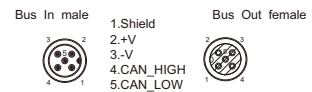

Station Address : 0 ... 64      Communication rate



U<sub>L</sub> : Load Power

7/8" Power supply

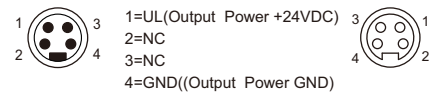

RS485 Extension Port 1/2/3/4



- 1.Link+
- 2.RS485A
- 3.Link-
- 4.RS485B

I/O address distribution table

Byte	Bit0	Bit1	Bit2	Bit3	Bit4	Bit5	Bit6	Bit7
0	C1P4	C1P2	C2P4	C2P2	C3P4	C3P2	C4P4	C4P2

I/O port 8DIO(self-adaption) M12 x 1 Input Part

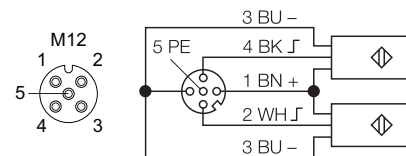

I/O port 8DIO(self-adaption) M12 x 1 Input Part

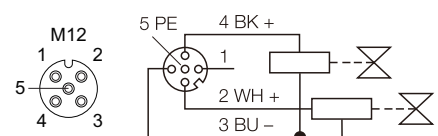

## Digital input extension module

### Module information

	GXC-DI8 4 x M12	GXC-DI8-N 4 x M12	GXC-DI8-M8 8 x M8	GXC-DI8-M8-N 8 x M8
Extension module 8 channel Digital input	 PNP	 NPN	 PNP	 NPN

### Connection

Extension port	1 x M8, 4PIN, Male ; 1 x M8, 4PIN, Female	1 x M8, 4PIN, Male ; 1 x M8, 4PIN, Female
Power port	1 x M8, 4PIN, Male ; 1 x M8, 4PIN, Female	1 x M8, 4PIN, Male ; 1 x M8, 4PIN, Female
I/O port	4 x M12, A-Code	8 x M8

### Input parameter

Number of input	8 channel	8 channel
Input signal	3-wire sensors, or mes. switches	3-wire sensors, or mes. switches
Input voltage	18...30 VDC	18...30 VDC
Operating current	<150 mA, Short circuit protection	<150 mA, Short circuit protection
Switching threshold	2 mA/4 mA	2 mA/4 mA
Input delay	2.5 ms	2.5 ms
Switching frequency	≤ 250 Hz	≤ 250 Hz



### Module LED- indicator

U <sub>s</sub> /U <sub>p</sub> Power	Green : Power OK, Red : Power Fault	Green : Power OK, Red : Power Fault
E1/E2 Extension Port	Green : communication ok, Red : communication fault	Green : communication ok, Red : communication fault
I/O Port	Green : I/O OK, Red : I/O Fault	Green : I/O OK, Red : I/O Fault

### Basic parameters

Rated voltage	18-30VDC	18-30VDC
Power dissipation	Max.80mA	Max.80mA
Protection class	IP67	IP67
Operating temperature	-30°C~70°C	-30°C~70°C
Storage temperature	-40°C~85°C	-40°C~85°C

### Pin Definition

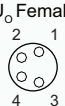
	Extension port - 2 x M8		Power port - 2 x M8	
Extension port & power port pin definition	 Port1 1 2 3 4	 Port2 2 1 4 3	 U <sub>s</sub> Male 1 2 3 4	 U <sub>o</sub> Female 2 1 4 3
	1.Link+ 2.RS485A 3.Link- 4.RS485B	1.U <sub>s</sub> 2.U <sub>p</sub> 3.GND <sub>s</sub> 4.GND <sub>p</sub>		

### I/O Port

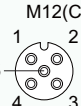
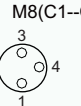
Pin definition & Address distribution	I/O port- 4 x M12	I/O Port - 8 x M8																																				
	 M12(C1-C4) 1 2 5 4 3	 M8(C1-C8) 3 4 1																																				
	1.24VDC+ 2.Input 3.0 4.Input 5.PE	1.24VDC 3.GND 4.Input																																				
	<table border="1"> <thead> <tr> <th>Byte</th> <th>Bit0</th> <th>Bit1</th> <th>Bit2</th> <th>Bit3</th> <th>Bit4</th> <th>Bit5</th> <th>Bit6</th> <th>Bit7</th> </tr> </thead> <tbody> <tr> <td>0</td> <td>C1P4</td> <td>C1P2</td> <td>C2P4</td> <td>C2P2</td> <td>C3P4</td> <td>C3P2</td> <td>C4P4</td> <td>C4P2</td> </tr> </tbody> </table>	Byte	Bit0	Bit1	Bit2	Bit3	Bit4	Bit5	Bit6	Bit7	0	C1P4	C1P2	C2P4	C2P2	C3P4	C3P2	C4P4	C4P2	<table border="1"> <thead> <tr> <th>Byte</th> <th>Bit0</th> <th>Bit1</th> <th>Bit2</th> <th>Bit3</th> <th>Bit4</th> <th>Bit5</th> <th>Bit6</th> <th>Bit7</th> </tr> </thead> <tbody> <tr> <td>0</td> <td>C1P4</td> <td>C2P4</td> <td>C3P4</td> <td>C4P4</td> <td>C5P4</td> <td>C6P4</td> <td>C7P4</td> <td>C8P4</td> </tr> </tbody> </table>	Byte	Bit0	Bit1	Bit2	Bit3	Bit4	Bit5	Bit6	Bit7	0	C1P4	C2P4	C3P4	C4P4	C5P4	C6P4	C7P4	C8P4
Byte	Bit0	Bit1	Bit2	Bit3	Bit4	Bit5	Bit6	Bit7																														
0	C1P4	C1P2	C2P4	C2P2	C3P4	C3P2	C4P4	C4P2																														
Byte	Bit0	Bit1	Bit2	Bit3	Bit4	Bit5	Bit6	Bit7																														
0	C1P4	C2P4	C3P4	C4P4	C5P4	C6P4	C7P4	C8P4																														

### Mechanical dimensions

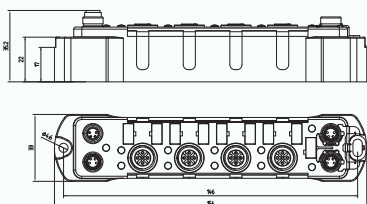
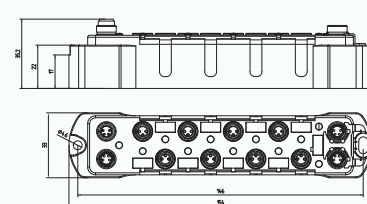
M12& M8		
---------	---	--

## Digital Output extension module

### Module information

	GXC-DO8 4 x M12	GXC-DO8-H 4 x M12	GXC-DO8-M8 8 x M8	GXC-DO8-M8-H 8 x M8
Extension module 8 channel Digital input	 0.5A	 2A	 0.5A	 2A

### Connection

Extension port	1 x M8 , 4PIN, Male ; 1 x M8 , 4PIN, Female	1 x M8 , 4PIN, Male ; 1 x M8 , 4PIN, Female
Power port	1 x M8 , 4PIN, Male ; 1 x M8 , 4PIN, Female	1 x M8 , 4PIN, Male ; 1 x M8 , 4PIN, Female
I/O port	4 x M12 , A-Code	8 x M8

### Output parameter

Number of output	8 channel	8 channel
Output voltage	18...30 VDC	18...30 VDC
Output current /channel	0.5 A , Short circuit protection	2A , Short circuit protection
Load type	resistive, inductive, lamp load	resistive, inductive, lamp load
Simultaneity factor	1	1
Switching frequency	≤ 250 Hz	≤ 250 Hz
Max. output current	0.7A/ch.(Amax=16*0.7A)	2A/ch.(Amax=8*2A)

### Module LED- indicator

U <sub>s</sub> /U <sub>p</sub> Power	Green : Power OK , Red : Power Fault	Green : Power OK , Red : Power Fault
E1/E2 Extension Port	Green : communication ok , Red : communication fault	Green : communication ok , Red : communication fault
I/O Port	Green : I/O OK , Red : I/O Fault	Green : I/O OK , Red : I/O Fault

### Basic parameters

Rated voltage	18-30VDC	18-30VDC
Power dissipation	Max.80mA	Max.80mA
Protection class	IP67	IP67
Operating temperature	-30°C~70°C	-30°C~70°C
Storage temperature	-40°C~85°C	-40°C~85°C

### Pin Definition

Extension port & power port pin definition	<p>Extension port - 2 x M8</p> <p>Port1 1 2 3 4</p> <p>1.Link+ 2.RS485A 3.Link- 4.RS485B</p> <p>Port2 2 1 4 3</p>	<p>Power port - 2 x M8</p> <p>U<sub>i</sub> Male 1 2 3 4</p> <p>1.U<sub>s</sub> 2.U<sub>p</sub> 3.GND<sub>s</sub> 4.GND<sub>p</sub></p> <p>U<sub>o</sub> Female 2 1 4 3</p>
--	---	---

### I/O Port

Pin definition & Address distribution	<p>I/O port - 4 x M12</p> <p>M12 ( C1-C4)</p> <p>1 2 5 4 3</p> <p>1.NC 2.Output 3.0 4.Output 5.PE</p> <table border="1"> <tr> <td>Byte</td> <td>Bit0</td> <td>Bit1</td> <td>Bit2</td> <td>Bit3</td> <td>Bit4</td> <td>Bit5</td> <td>Bit6</td> <td>Bit7</td> </tr> <tr> <td>0</td> <td>C1P4</td> <td>C1P2</td> <td>C2P4</td> <td>C2P2</td> <td>C3P4</td> <td>C3P2</td> <td>C4P4</td> <td>C4P2</td> </tr> </table>	Byte	Bit0	Bit1	Bit2	Bit3	Bit4	Bit5	Bit6	Bit7	0	C1P4	C1P2	C2P4	C2P2	C3P4	C3P2	C4P4	C4P2	<p>I/O port - 8 x M8</p> <p>M8(C1-C8)</p> <p>3 4 1</p> <p>1.NC 3.GND 4.Output</p> <table border="1"> <tr> <td>Byte</td> <td>Bit0</td> <td>Bit1</td> <td>Bit2</td> <td>Bit3</td> <td>Bit4</td> <td>Bit5</td> <td>Bit6</td> <td>Bit7</td> </tr> <tr> <td>0</td> <td>C1P4</td> <td>C2P4</td> <td>C3P4</td> <td>C4P4</td> <td>C5P4</td> <td>C6P4</td> <td>C7P4</td> <td>C8P4</td> </tr> </table>	Byte	Bit0	Bit1	Bit2	Bit3	Bit4	Bit5	Bit6	Bit7	0	C1P4	C2P4	C3P4	C4P4	C5P4	C6P4	C7P4	C8P4
	Byte	Bit0	Bit1	Bit2	Bit3	Bit4	Bit5	Bit6	Bit7																													
0	C1P4	C1P2	C2P4	C2P2	C3P4	C3P2	C4P4	C4P2																														
Byte	Bit0	Bit1	Bit2	Bit3	Bit4	Bit5	Bit6	Bit7																														
0	C1P4	C2P4	C3P4	C4P4	C5P4	C6P4	C7P4	C8P4																														

### Mechanical dimensions

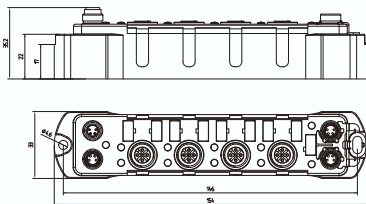
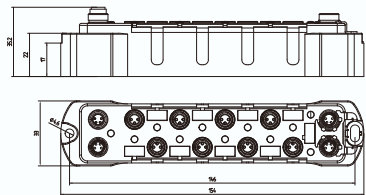
M12& M8		
---------	---	--

## Digital input and output extension module

### Module information

Extension module  
8 channel Digital input  
and output  
(self-adaption)

GXC-DIO8 4 x M12



8 channel Digital input and output (self-adaption)  
(pnp, 0.5A)

### Connection

Extension port	1 x M8 , 4PIN, Male ; 1 x M8 , 4PIN, Female
Power port	1 x M8 , 4PIN, Male ; 1 x M8 , 4PIN, Female
I/O port	4 x M12 , A-Code

### Input parameter

Number of input	8 channel
Input signal	3-wire sensors, or mes. switches
Input voltage	18...30 VDC
Operating current	<150 mA , Short circuit protection
Switching threshold	2 mA/4 mA
Input delay	2.5 ms
Switching frequency	≤ 250 Hz

### Output parameter

Number of output	8 channel
Output voltage	18...30 VDC
Output current /channel	0.5 A , Short circuit protection
Load type	resistive, inductive, lamp load
Simultaneity factor	1
Switching frequency	≤ 250 Hz
Max. output current	0.7A/ch.(Amax=16*0.7A)

### Module LED- indicator

U <sub>s</sub> /U <sub>p</sub> Power	Green : Power OK , Red : Power Fault
E1/E2 Extension Port	Green : communication ok , Red : communication fault
I/O Port	Green : I/O OK , Red : I/O Fault

### Basic parameters

Rated voltage	18-30VDC
Power dissipation	Max.80mA
Protection class	IP67
Operating temperature	-30°C~70°C
Storage temperature	-40°C~85°C

### Pin Definition

	Extension port - 2 x M8				Power port - 2 x M8			
Extension port & power port pin definition	Port1		Port2		U <sub>i</sub> Male		U <sub>o</sub> Female	
	1	2	2	1	1	2	2	1
	3	4	4	3	3	4	4	3
	1.Link+ 2.RS485A 3.Link- 4.RS485B				1.U <sub>s</sub> 2.U <sub>p</sub> 3.GND <sub>s</sub> 4.GND <sub>p</sub>			

### I/O Port

Pin definition & Address distribution	I/O Port- 4 x M12								
	M12(C1-C4)								
	1	2	3	4	5	1.24VDC+	2.Input/output	3.0	4.Input/output
Byte	Bit0	Bit1	Bit2	Bit3	Bit4	Bit5	Bit6	Bit7	
0	C1P4	C1P2	C2P4	C2P2	C3P4	C3P2	C4P4	C4P2	

### Mechanical dimensions

M12

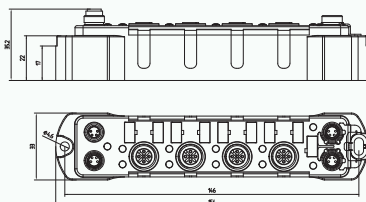

## Analog input extension module

### Module information

Extension module 4 channel Analog input	GXC-AI4-I 4 x M12  Current 0/4-20mA	GXC-AI4-U 4 x M12  Voltage -10/0-10V	GXC-AI4-I/U 4 x M12  Current/voltage configurable
--	--	---	--

### Connection

Extension port	1 x M8 , 4PIN, Male ; 1 x M8 , 4PIN, Female
Power port	1 x M8 , 4PIN, Male ; 1 x M8 , 4PIN, Female
I/O port	4 x M12 , A-Code

### Analog input

Channels	4		
Input resistance	About 100Ohm , differential input	< 100 kΩ	Current/voltage configurable ,
supply current	<200mA/ch. , Short circuit protection	<120 mA/ch. , Short circuit protection	Refer to current and voltage
Scaling Range	0 / 4...20mA	-10/0 ... +10 VDC	module parameters
Resolution	12bits (0-4095)/ 16bits(0-32767)		
Conversion time	≤10ms/ch.	≤5ms/ch.	≤10ms/ch.
Input type	Current	voltage	Current/voltage
Intrinsic error (25°C)	±0.3%		
repeatability precision	±0.05%		
sensor voltage	24VDC ( 18...30VDC ) , ≤200mA		





### Module LED- indicator

U <sub>s</sub> /U <sub>p</sub> Power	Green : Power OK , Red : Power Fault
E1/E2 Extension Port	Green : communication ok , Red : communication fault
I/O Port	Green : I/O OK , Red : I/O Fault

### Basic parameters

Rated voltage	18-30VDC
Power dissipation	Max.80mA
Protection class	IP67
Operating temperature	-30°C~70°C
Storage temperature	-40°C~85°C

### Pin Definition

Extension port & power port pin definition	Extension port - 2 x M8		Power port - 2 x M8	
	Port1  1 2 3 4	Port2  2 1 4 3	U <sub>i</sub> Male  1 2 3 4	U <sub>o</sub> Female  2 1 4 3

### I/O Port

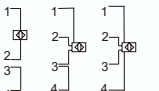
Pin definition & Address distribution	I/O port - 4 x M12 AI ( I , U , I/U )								
	 1 2 3 4 5		M12 1 2 3 4 5		1.24VDC+ 2.A+ 3.0V 4.A- 5.PE				
Address		Byte0	Byte1	Byte2	Byte3	Byte4	Byte5	Byte6	Byte7
Channel		C1(A0)	C2(A1)	C3(A2)	C4(A3)				

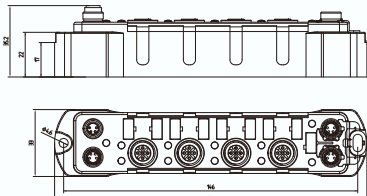

### Mechanical dimensions

M12	
-----	---



## Analog input extension module

### Module information

Extension module 4 channel Analog input	GXC-AI4-RTD    4 x M12	GXC-AI4-TC    4 x M12
	 RTD	 Thermocouple

### Connection

Extension port	1 x M8 , 4PIN, Male ; 1 x M8 , 4PIN, Female
Power port	1 x M8 , 4PIN, Male ; 1 x M8 , 4PIN, Female
I/O port	4 x M12 , A-Code

### Analog input

Channels	4	
Resolution	15bits+polarity bit	
Conversion time	20ms / ch.	
Input type	Pt100, Pt200, Pt500, Pt1000, Ni100, Ni1000 0...100Ω, 0...200Ω, 0...400Ω, 0...1000Ω	Types E / S / J / T / K / B / N / C / R / L
Intrinsic error	< 0.2 %	
Repeatability	±0.05%	
Temp. coefficient	full range < 300 ppm/°C	
sensor voltage	24VDC ( 18...30VDC ) , ≤200mA	





### Module LED- indicator

U <sub>s</sub> /U <sub>p</sub> Power	Green : Power OK , Red : Power Fault
E1/E2 Extension Port	Green : communication ok , Red : communication fault
I/O Port	Green : I/O OK , Red : I/O Fault





### Basic parameters

Rated voltage	18-30VDC
Power dissipation	Max.80mA
Protection class	IP67
Operating temperature	-30°C~70°C
Storage temperature	-40°C~85°C

### Pin Definition

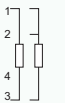
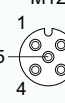
Extension port & power port pin definition	Extension port - 2 x M8		Power port - 2 x M8	
	Port1  1 2 3 4	Port2  2 1 4 3	U <sub>i</sub> Male  1 2 3 4	U <sub>o</sub> Female  2 1 4 3

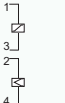
### I/O Port

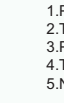
Pin definition & Address distribution	I/O port - 4 x M12    AI ( RTD ) M12				I/O port - 4 x M12    AI ( TC ) M12			
								
	1.Red 2.Red 3.White 4.White 5.NC	1.Red 2.Red 3.White 4.White 5.NC	1.Red 2.Red 3.White 4.White 5.NC	1.Red 2.Red 3.White 4.White 5.NC	1.PT1000 2.TC+ 3.PT1000 4.TC- 5.NC	1.PT1000 2.TC+ 3.PT1000 4.TC- 5.NC	1.PT1000 2.TC+ 3.PT1000 4.TC- 5.NC	1.PT1000 2.TC+ 3.PT1000 4.TC- 5.NC
Address	Byte0	Byte1	Byte2	Byte3	Byte4	Byte5	Byte6	Byte7
Channel	C1(A0)	C2(A1)	C3(A2)	C4(A3)	C1(A0)	C2(A1)	C3(A2)	C4(A3)

### Mechanical dimensions

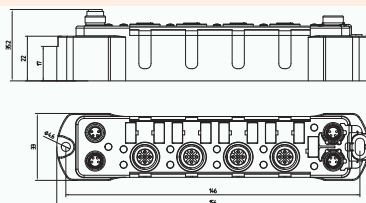
M12	
-----	---

## Analog Output extension module

### Module information

	GXC-AO4-I 4 x M12	GXC-AO4-U 4 x M12	GXC-AO4-I/U 4 x M12
Extension module			
4 channel Analog output	Current 0/4-20mA	Voltage -10/0-10V	Current/voltage configurable

### Connection

Extension port	1 x M8, 4PIN, Male ; 1 x M8, 4PIN, Female
Power port	1 x M8, 4PIN, Male ; 1 x M8, 4PIN, Female
I/O port	4 x M12, A-Code

### Analog output

Channels	4		
Impedance	$\geq 500\Omega(I)$	$\geq 1\text{ k}\Omega(U)$	Current/voltage configurable ,
Output range	0 / 4...20mA	-10/0 ... +10 VDC	Refer to current and voltage
Resolution	12bits(0-4095)/16bits(0-32767)		module parameters
Conversion time	$\leq 10\text{ms/ch.}$		
sensor voltage	24VDC(18...30V) , $\leq 200\text{mA}$		
Output type	Current	Voltage	Current/voltage configurable

GXC



### Module LED- indicator

$U_s/U_p$ Power	Green : Power OK , Red : Power Fault
E1/E2 Extension Port	Green : communication ok , Red : communication fault
I/O Port	Green : I/O OK , Red : I/O Fault

### Basic parameters

Rated voltage	18-30VDC
Power dissipation	Max.80mA
Protection class	IP67
Operating temperature	-30°C~70°C
Storage temperature	-40°C~85°C

### Pin Definition

Extension port & power port pin definition	Extension port - 2 x M8		Power port - 2 x M8	
	Port1 1 2  3 4	1.Link+ 2.RS485A 3.Link- 4.RS485B	Port2 2 1  4 3	$U_i$ Male 1 2  3 4

### I/O Port

Pin definition & Address distribution	I/O port - 4 x M12 AO ( I, U, I/U )							
	M12 1 2  5 4 3		1.24VDC+ 2.A+ 3.0V 4.A- 5.PE					
	Address	Byte0	Byte1	Byte2	Byte3	Byte4	Byte5	Byte6
Channel	C1(A0)	C2(A1)	C3(A2)	C4(A3)				

### Mechanical dimensions

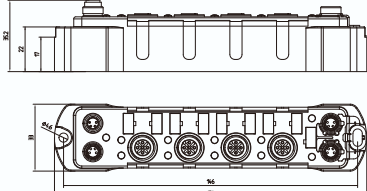
M12	
-----	---



**B.C.E. s.r.l.**  
Via Regina Pacis, 54/c - 41049 SASSUOLO (MO) Italy  
Tel. +39 0536 811.616 r.a. - Fax +39 0536 811.500  
[www.bce.it](http://www.bce.it) - E-mail: [bce@bce.it](mailto:bce@bce.it)



# Industrial Switch

# E

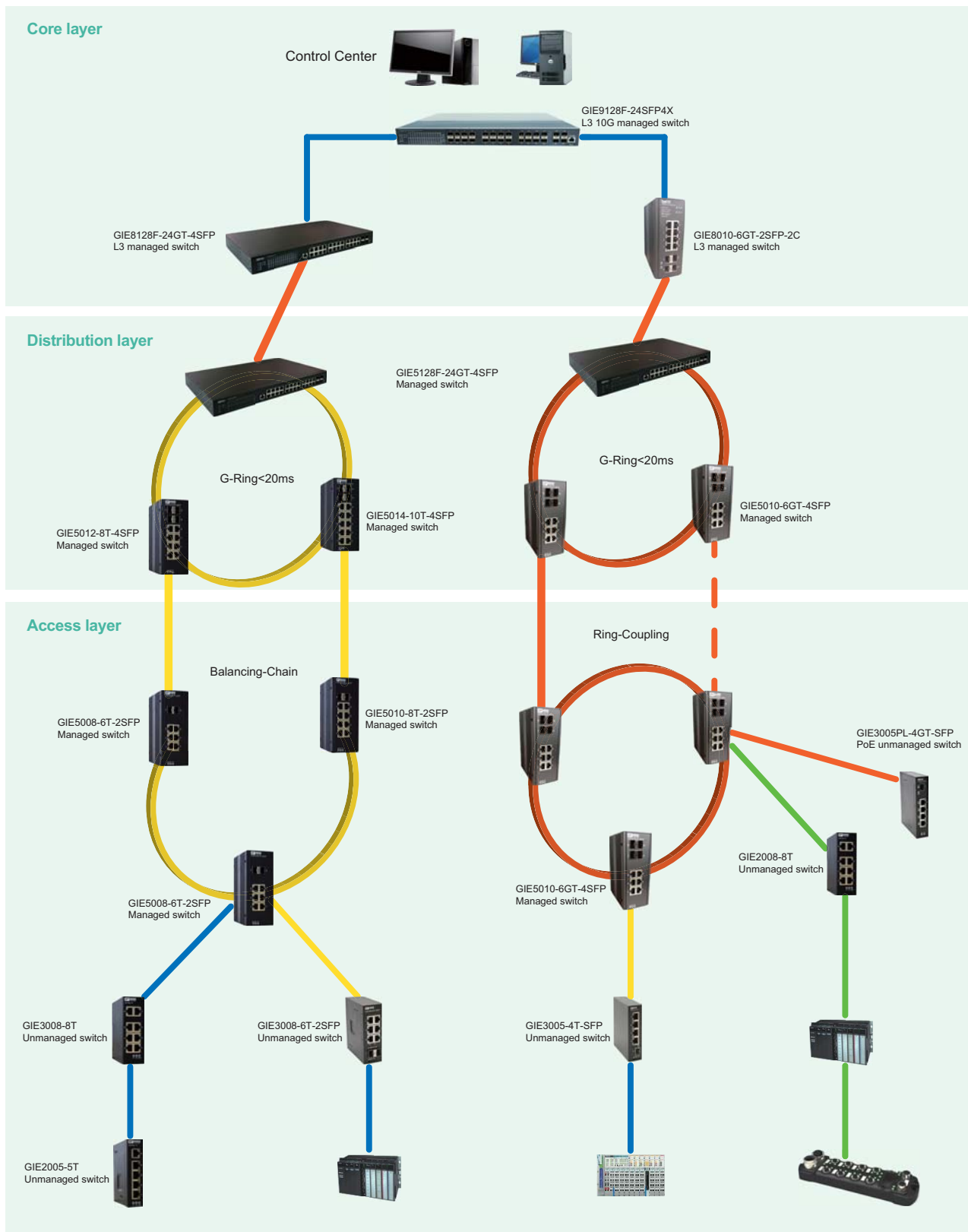

- 1000Base-X
- 100Base-FX
- 10/100BASE-T(X) or 10/100/1000BASE-T(X)

GIE

GSEE-TECH industrial Ethernet switch adopts G-Ring network technology, Link loss recovery < 20ms. The ports with hardware ESD protection, MDI/MDIX Auto-crossover, Support EtherNet/IP, ProfiNet, MODBUS TCP protocol. All products passed the high level electromagnetic compatibility test and passed CE, FCC and other certification. A full Gigabit network provides higher overall throughput than a legacy Fast Ethernet network, and reduce the response time for timing sensitive applications that may mix of video, voice and data in its traffic pipe. With the powerful features, managed switches are easily to prioritize, partition and organize user's network and provide reliable and good quality services.

GSEE-TECH has Media Converter, Unmanaged Switch, Managed Switch, Layer 3 Managed Switch, EN50155 Switch, PROFINET Switch, 10G Switch and so on.

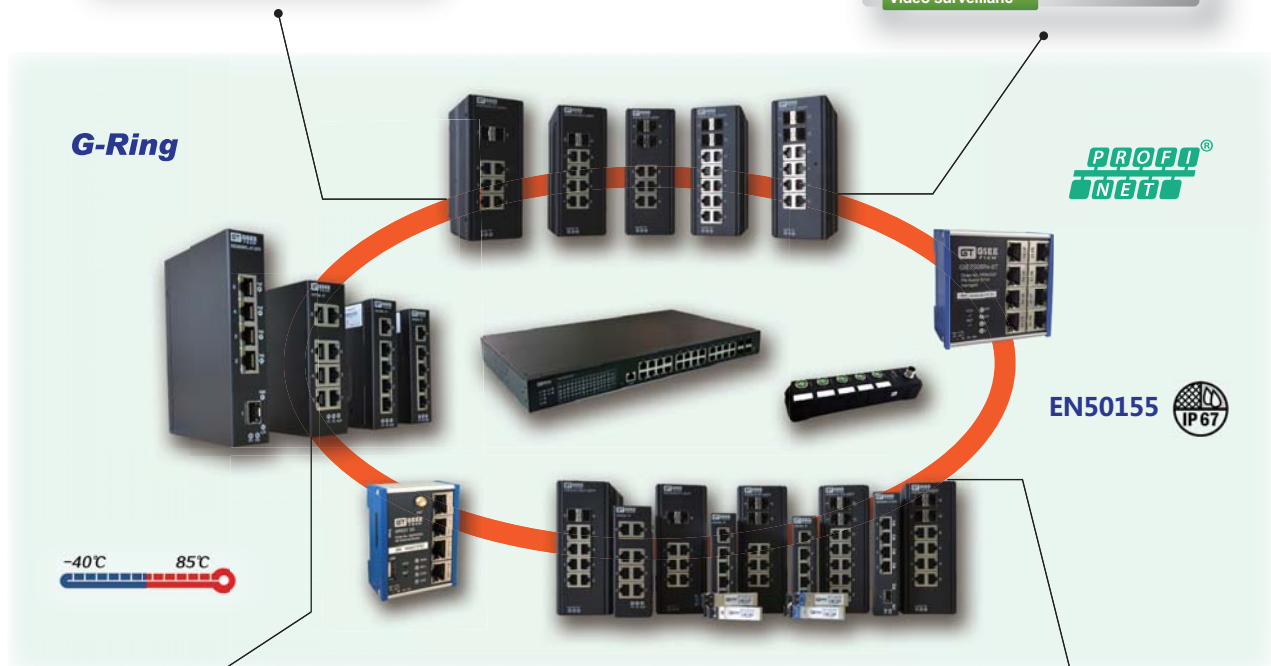
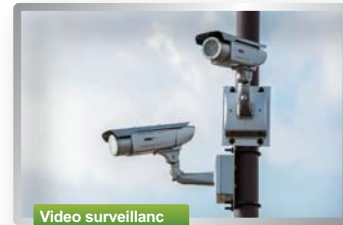
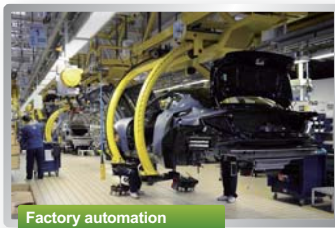

GIE

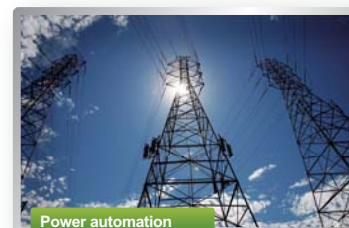

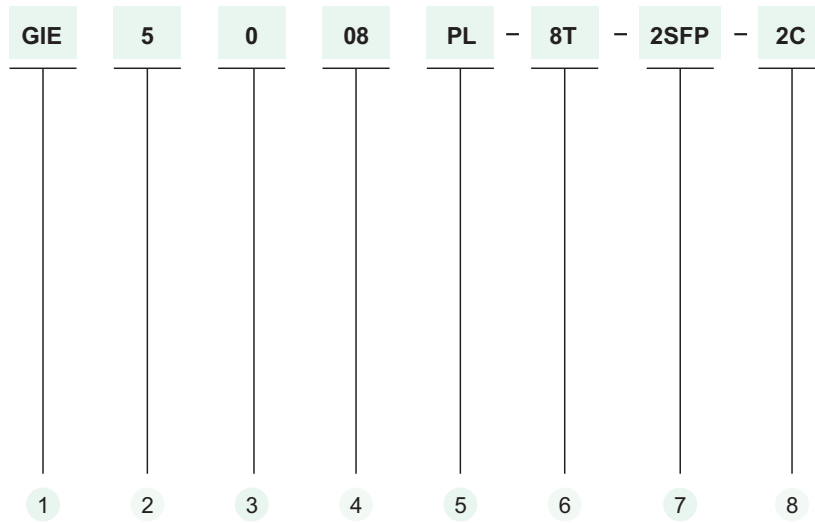

1 GIE Industrial Switch

5 PL - PoE Switch  
PN - PROFINET Switch

2 Types  
1 - Media Converter  
2 - Simple Unmanaged Switch  
3 - Unmanaged Switch  
5 - Managed Switch  
6 - 10G Managed Switch  
7 - PROFINET Switch  
8 - L3 Managed Switch  
9 - L3 10G Managed Switch

6 Port  
8T - 8-ports FE  
8GT-8-ports GE  
4P-4-ports PoE

3 Function  
0 - DIN-Rail  
1 - Rack  
3 - M12

7 Fiber ports  
2SFP - 2-ports SFP slot  
2SC - 2-ports SC  
4X - 4-ports 10G

4 Total ports

8 2C - 2-ports COMBO

GIE

- 5-ports unmanaged switch , the ports with hardware ESD protection , MDI/MDIX Auto-crossover
- Operating temperature -40 to +75°C (cold startup at -40°C) ,
- Support EtherNet/IP , ProfiNet , MODBUS TCP protocol
- Input voltage rang 12-58 VDC , Redundant Input Terminal
- Enable/Disable broadcast storm protection
- Certification compliance : **CE FCC**



Specifications

Standards	IEEE 802.3 (10Base-T) , IEEE 802.3u (100Base-T) , IEEE 802.3x , IEEE 802.1p
Switch Properties	Store and forward, wire-speed/non-blocking switching engine Number of queues per port : 4 MAC address : 2K
Interface	Copper RJ45 Ports : 10/100 Mbps speed auto-negotiation, MDI/MDIX Auto-crossover Fiber port : 100BaseFX ports (LC connector, multi-mode or single-mode), 1310nm DIP switches : Enable/Disable broadcast storm protection, Enable/Disable Power Alarm Indicators : Indication of power input status, Ethernet port status Link & Speed
Power	Power input : DC12V-DC58V Max. 132.3mA @ DC24V , Max. 3.2Watts Redundant Input Terminal Reverse power protection
Mechanical	Fan-less design , IP40 protection , metal housing Dimension : 112.2mm(H) x 29.1mm (W) x 89.4mm (D) Weight : 295g Installation option : DIN-Rail mounting, Wall mounting
Environmental	Operating temperature : -40 ~ 75°C Storage temperature : -40 ~ 85°C Humidity : 5 ~ 95%RH ( non-condensing )
EMS	IEC61000-4-2 (ESD) ±6kV(contact), ±8kV(air) IEC61000-4-3 (RS) 10V/m (80MHz~2GHz) IEC61000-4-4 (EFT) Power Port: ±2kV, Data Port: ±1kV IEC61000-4-5 (Surge) Power Port: ±1kV/DM, ±2kV/CM, Data Port: ±2kV IEC61000-4-6 (CS) 10V (150kHz~80MHz)
EMI	FCC Part 15/CISPR22 (EN55022) Class A
Immunity	IEC61000-6-2
Mechanical standard	IEC60068-2-6 (Vibration) IEC60068-2-27 (Shock) IEC60068-2-32 (Freefall)
RoHS&WEEE	RoHS (Pb free), WEEE compliant
MTBF	>25 years
Certification	CE, FCC

GIE

Order model

GIE2005-5T	5-ports RJ45 10/100BaseT(X) , unmanaged switch
GIE2005-4T-LC2	4-ports RJ45 10/100BaseT(X) , 1-port 100BaseFX LC typically for fiber , Multi-Mode (2KM) , 1310nm , unmanaged switch
GIE2005-4T-LC20	4-ports RJ45 10/100BaseT(X) , 1-port 100BaseFX LC typically for fiber , Single-Mode (20KM) , 1310nm , unmanaged switch

Product description

GIE2005 series is the best cost-effective solution for industrial applications, providing copper and fiber connectivity based on field needs. It is designed for supporting standard industrial applications without complex setup to make the network truly plug-and-play. With its compact design, IIS-305 series is perfectly fit for the field-site applications.



## Unmanaged Switch

- 8-ports unmanaged switch , the ports with hardware ESD protection , MDI/MDIX Auto-crossover
- Operating temperature -40 to +75°C (cold startup at -40°C) ,
- Support EtherNet/IP , ProfiNet , MODBUS TCP protocol
- Input voltage rang 12-58 VDC , Redundant Input Terminal
- Enable/Disable broadcast storm protection
- Certification compliance : **CE** **FC**



### Specifications

Standards	IEEE 802.3 (10Base-T) , IEEE 802.3u (100Base-T) , IEEE 802.3x , IEEE 802.1p
Switch Properties	Store and forward, wire-speed/non-blocking switching engine Number of queues per port : 4 MAC address : 2K
Interface	Copper RJ45 Ports : 10/100 Mbps speed auto-negotiation, MDI/MDIX Auto-crossover Fiber port : 100BaseSFP slots DIP switches : Enable/Disable broadcast storm protection, Enable/Disable Power Alarm Indicators : Indication of power input status, Ethernet port status Link & Speed
Power	Power input : DC12V-DC58V Max. 298mA @ DC24V , Max. 7Watts Redundant Input Terminal Reverse power protection
Mechanical	Fan-less design , IP40 protection , metal housing Dimension : 117.8mm(H) x 39mm (W) x 96.9mm (D) Weight : 395g Installation option : DIN-Rail mounting, Wall mounting
Environmental	Operating temperature : -40 ~ 75°C Storage temperature : -40 ~ 85°C Humidity : 5 ~ 95%RH ( non-condensing )
EMS	IEC61000-4-2 (ESD) ±6kV(contact), ±8kV(air) IEC61000-4-3 (RS) 10V/m (80MHz~2GHz) IEC61000-4-4 (EFT) Power Port: ±2kV, Data Port: ±1kV IEC61000-4-5 (Surge) Power Port: ±1kV/DM, ±2kV/CM, Data Port: ±2kV IEC61000-4-6 (CS) 10V (150kHz~80MHz)
EMI	FCC Part 15/CISPR22 (EN55022) Class A
Immunity	IEC61000-6-2
Mechanical standard	IEC60068-2-6 (Vibration) IEC60068-2-27 (Shock) IEC60068-2-32 (Freefall)
RoHS&WEEE	RoHS (Pb free), WEEE compliant
MTBF	>25 years
Certification	CE, FCC

### Order model

GIE2008-8T	8-ports RJ45 10/100BaseT(X) , unmanaged switch
GIE2008-6T-2SFP	6-ports RJ45 10/100BaseT(X) , 2-ports 100BaseFX SFP slot , unmanaged switch

### Accessories

GSFP-SX-MM-0102I	Industrial Multi-mode 100Mbps 2KM Fiber Transceiver, LC typically for fiber, 850nm, -40~85°C
GSFP-SX-MM1-0102I	Industrial Multi-mode 100Mbps 2KM Fiber Transceiver, LC typically for fiber, 1310nm, -40~85°C
GSFP-LX-SM-0130I	Industrial Single-mode 100Mbps 30Km Fiber Transceiver, LC typically for fiber, 1310nm, -40~85°C

Remarks: the above SFP Transceivers are common modules, if there are other special specifications, please consult the customer service

### Product description

GIE2008 series is the best cost-effective solution for industrial applications, providing copper and fiber connectivity based on field needs. It is designed for supporting standard industrial applications without complex setup to make the network truly plug-and-play. With its compact design, IIS-308 series is perfectly fit for the field-site applications.

- 5-ports Gigabit unmanaged switch , the ports with hardware ESD protection , MDI/MDIX Auto-crossover
- Operating temperature -40 to +75°C (cold startup at -40°C) ,
- Support EtherNet/IP , ProfiNet , MODBUS TCP protocol
- Input voltage rang 12-58 VDC , Redundant Input Terminal
- Enable/Disable broadcast storm protection
- Certification compliance : **CE** **FC**



Specifications

Standards	IEEE 802.3 (10Base-T) , IEEE 802.3u (100Base-T) , IEEE 802.3ab (1000Base-T) , IEEE 802.3z (1000Base-X) IEEE 802.3x , IEEE 802.1p
Switch Properties	Store and forward, L2-wire-speed/non-blocking switching engine Number of queues per port : 4 MAC address : 2K Jumbo frames : 9K Bytes
Interface	Copper RJ45 Ports : 10/100/1000 Mbps speed auto-negotiation, MDI/MDIX Auto-crossover Fiber port : SFP slots , 100/1000BaseFX DIP switches : Enable/Disable broadcast storm protection, Enable/Disable Power Alarm Indicators : Indication of power input status, Ethernet port status Link & Speed
Power	Power input : DC12V-DC58V Max. 158.3mA @ DC24V , Max. 3.8Watts Redundant Input Terminal Reverse power protection
Mechanical	Fan-less design , IP40 protection , metal housing Dimension : 112.2mm(H) x 29.1mm (W) x 89.4mm (D) Weight : 329g Installation option : DIN-Rail mounting, Wall mounting
Environmental	Operating temperature : -40 ~ 75°C Storage temperature : -40 ~ 85°C Humidity : 5 ~ 95%RH ( non-condensing )
EMS	IEC61000-4-2 (ESD) ±6kV(contact), ±8kV(air) IEC61000-4-3 (RS) 10V/m (80MHz~2GHz) IEC61000-4-4 (EFT) Power Port: ±2kV, Data Port: ±1kV IEC61000-4-5 (Surge) Power Port: ±1kV/DM, ±2kV/CM, Data Port: ±2kV IEC61000-4-6 (CS) 10V (150kHz~80MHz)
EMI	FCC Part 15/CISPR22 (EN55022) Class A
Immunity	IEC61000-6-2
Mechanical standard	IEC60068-2-6 (Vibration) IEC60068-2-27 (Shock) IEC60068-2-32 (Freefall)
RoHS&WEEE	RoHS (Pb free), WEEE compliant
MTBF	>25 years
Certification	CE, FCC

GIE

Order model

GIE3005-5T	5-ports RJ45 10/100BaseT(X) , unmanaged switch
GIE3005-4T-SFP	4-ports RJ45 10/100BaseT(X) , 1-ports 100/1000BaseFX SFP slot , unmanaged switch
GIE3005-5GT	5-ports RJ45 10/100/1000BaseT(X) , Gigabit unmanaged switch
GIE3005-4GT-SFP	4-ports RJ45 10/100/1000BaseT(X) , 1-ports 100/1000BaseFX SFP slot , Gigabit unmanaged switch

Accessories

GSFP-SX-MM-0102I	Industrial Multi-mode 100Mbps 2KM Fiber Transceiver, LC typically for fiber, 850nm, -40~85°C
GSFP-SX-MM1-0102I	Industrial Multi-mode 100Mbps 2KM Fiber Transceiver, LC typically for fiber, 1310nm, -40~85°C
GSFP-LX-SM-0130I	Industrial Single-mode 100Mbps 30Km Fiber Transceiver, LC typically for fiber, 1310nm, -40~85°C
GSFP-SX-MM-0202I	Industrial 1000Base-SX+ multi-mode transceiver 2km, LC typically for fiber, 1310nm, -40~85°C
GSFP-LX-SM-0210I	Industrial 1000Base-LX single-mode transceiver 10Km, LC typically for fiber, 1310nm, -40~85°C
GSFP-LX-SM-0230I	Industrial 1000Base-LHX single-mode transceiver 30km, LC typically for fiber, 1310nm, -40~85°C

Remarks: the above SFP Transceivers are common modules, If there are other special specifications, please consult the customer service

## Unmanaged Switch

- 8-ports Gigabit unmanaged switch , the ports with hardware ESD protection , MDI/MDIX Auto-crossover
- Operating temperature -40 to +75°C (cold startup at -40°C) ,
- Support EtherNet/IP , ProfiNet , MODBUS TCP protocol
- Input voltage rang 12-58 VDC , Redundant Input Terminal
- Enable/Disable broadcast storm protection
- Certification compliance : **CE FC**



### Specifications

Standards	IEEE 802.3 (10Base-T) , IEEE 802.3u (100Base-T) , IEEE 802.3ab (1000Base-T) , IEEE 802.3z (1000Base-X) , IEEE 802.3x , IEEE 802.1p
Switch Properties	Store and forward, L2-wire-speed/non-blocking switching engine Number of queues per port : 4 MAC address : 8K Jumbo frames : 9K Bytes
Interface	Copper RJ45 Ports : 10/100/1000 Mbps speed auto-negotiation, MDI/MDIX Auto-crossover Fiber port : SFP slots , 100/1000BaseFX DIP switches : Enable/Disable broadcast storm protection, Enable/Disable Power Alarm Indicators : Indication of power input status, Ethernet port status Link & Speed
Power	Power input : DC12V-DC58V Max. 329mA @ DC24V, Max. 7.9Watts Redundant Input Terminal Reverse power protection
Mechanical	Fan-less design , IP40 protection , metal housing Dimension : 117.8mm(H) x 39mm (W) x 96.9mm (D) Weight : 439g Installation option : DIN-Rail mounting, Wall mounting
Environmental	Operating temperature : -40 ~ 75°C Storage temperature : -40 ~ 85°C Humidity : 5 ~ 95%RH ( non-condensing )
EMS	IEC61000-4-2 (ESD) ±6kV(contact), ±8kV(air) IEC61000-4-3 (RS) 10V/m (80MHz~2GHz) IEC61000-4-4 (EFT) Power Port: ±2kV, Data Port: ±1kV IEC61000-4-5 (Surge) Power Port: ±1kV/DM, ±2kV/CM, Data Port: ±2kV IEC61000-4-6 (CS) 10V (150kHz~80MHz)
EMI	FCC Part 15/CISPR22 (EN55022) Class A
Immunity	IEC61000-6-2
Mechanical standard	IEC60068-2-6 (Vibration) IEC60068-2-27 (Shock) IEC60068-2-32 (Freefall)
RoHS&WEEE	RoHS (Pb free), WEEE compliant
MTBF	>25 years
Certification	CE, FCC

### Order model

GIE3008-8T	8-ports RJ45 10/100BaseT(X) , unmanaged switch
GIE3008-6T-2SFP	6-ports RJ45 10/100BaseT(X) , 2-ports 100/1000BaseFX SFP slot , unmanaged switch
GIE3008-8GT	8-ports RJ45 10/100/1000BaseT(X) , Gigabit unmanaged switch
GIE3008-6GT-2SFP	6-ports RJ45 10/100/1000BaseT(X) , 2-ports 100/1000BaseFX SFP slot , Gigabit unmanaged switch

### Accessories

GSFP-SX-MM-0102I	Industrial Multi-mode 100Mbps 2KM Fiber Transceiver, LC typically for fiber, 850nm, -40~85°C
GSFP-SX-MM1-0102I	Industrial Multi-mode 100Mbps 2KM Fiber Transceiver, LC typically for fiber, 1310nm, -40~85°C
GSFP-LX-SM-0130I	Industrial Single-mode 100Mbps 30Km Fiber Transceiver, LC typically for fiber, 1310nm, -40~85°C
GSFP-SX-MM-0202I	Industrial 1000Base-SX+ multi-mode transceiver 2km, LC typically for fiber, 1310nm, -40~85°C
GSFP-LX-SM-0210I	Industrial 1000Base-LX single-mode transceiver 10Km, LC typically for fiber, 1310nm, -40~85°C
GSFP-LX-SM-0230I	Industrial 1000Base-LHX single-mode transceiver 30km, LC typically for fiber, 1310nm, -40~85°C

Remarks: the above SFP Transceivers are common modules, If there are other special specifications, please consult the customer service

- 26-ports Gigabit unmanaged switch , the ports with hardware ESD protection , MDI/MDIX Auto-crossover
- Operating temperature -40 to +75°C (cold startup at -40°C) ,
- Support EtherNet/IP , ProfiNet , MODBUS TCP protocol
- Input voltage rang 12-58 VDC , Redundant Input Terminal
- Enable/Disable broadcast storm protection
- Certification compliance : **CE FC**



Specifications

Standards	IEEE 802.3 (10Base-T) , IEEE 802.3u (100Base-T) , IEEE 802.3ab (1000Base-T) , IEEE 802.3z (1000Base-X) , IEEE 802.3x , IEEE 802.1p
Switch Properties	Store and forward, L2-wire-speed/non-blocking switching engine Number of queues per port : 8 MAC address : 8K Jumbo frames : 9K Bytes
Interface	Copper RJ45 Ports : 10/100/1000 Mbps speed auto-negotiation, MDI/MDIX Auto-crossover Fiber port : SFP slots , 100/1000BaseFX Indicators : Indication of power input status, Ethernet port status Link & Speed
Power	Input power : AC110V-AC240V , Max. 100mA @ AC220V , Max. 22Watts Support over current protection Dual redundant power input with power cable
Mechanical	Fan-less design , IP30 protection , metal housing Dimension : 44mm(H) x 440mm (W) x 253mm (D) Weight : 3000g Installation option : 1U 19" rack mounting
Environmental	Operating temperature : -40 ~ 75°C Storage temperature : -40 ~ 85°C Humidity : 5 ~ 95%RH ( non-condensing )
EMS	IEC61000-4-2 (ESD) ±6kV(contact), ±8kV(air) IEC61000-4-3 (RS) 10V/m (80MHz~2GHz) IEC61000-4-4 (EFT) Power Port: ±2kV, Data Port: ±1kV IEC61000-4-5 (Surge) Power Port: ±1kV/DM, ±2kV/CM, Data Port: ±2kV IEC61000-4-6 (CS) 10V (150kHz~80MHz)
EMI	FCC Part 15/CISPR22 (EN55022) Class A
Immunity	IEC61000-6-2
Mechanical standard	IEC60068-2-6 (Vibration) IEC60068-2-27 (Shock) IEC60068-2-32 (Freefall)
RoHS&WEEE	RoHS (Pb free), WEEE compliant
MTBF	>25 years
Certification	CE, FCC

GIE

Order model

GIE3126F-24T-2SFP	Front Access , 24-ports RJ45 10/100BaseT(X) , 2-ports 100/1000BaseSFP slots , unmanaged switch
GIE3126F-24GT-2SFP	Front Access , 24-ports RJ45 10/100/1000BaseT(X) ,2-ports 100/1000BaseSFP slots , unmanaged switch

Remarks : the above model are front access, if you need rear access, please consult the customer service

Accessories

GSFP-SX-MM-0102I	Industrial Multi-mode 100Mbps 2KM Fiber Transceiver, LC typically for fiber, 850nm, -40~85°C
GSFP-SX-MM1-0102I	Industrial Multi-mode 100Mbps 2KM Fiber Transceiver, LC typically for fiber, 1310nm, -40~85°C
GSFP-LX-SM-0130I	Industrial Single-mode 100Mbps 30Km Fiber Transceiver, LC typically for fiber, 1310nm, -40~85°C
GSFP-SX-MM-0202I	Industrial 1000Base-SX+ multi-mode transceiver 2km, LC typically for fiber, 1310nm, -40~85°C
GSFP-LX-SM-0210I	Industrial 1000Base-LX single-mode transceiver 10Km, LC typically for fiber, 1310nm, -40~85°C
GSFP-LX-SM-0230I	Industrial 1000Base-LHX single-mode transceiver 30km, LC typically for fiber, 1310nm, -40~85°C

Remarks: the above SFP Transceivers are common modules, If there are other special specifications, please consult the customer service

## Managed Switch

- 8-ports managed switch , Static routing, support the communication between different vlans
- Spanning tree STP, RSTP & MSTP, G-Ring fail -over protection (< 20 ms)
- VLAN, IGMP, DHCP, SNMP, QoS, ACL, HTTPS, SSH
- The ports with hardware ESD protection , MDI/MDIX Auto-crossover
- Support EtherNet/IP , ProfiNet , MODBUS TCP protocol
- Certification compliance : **CE FC**



### Specifications

Standards	IEEE 802.3 (10Base-T) , IEEE 802.3u (100Base-T) , IEEE 802.3ab (1000Base-T) , IEEE 802.3z (1000Base-X) IEEE 802.3x IEEE 802.1p IEEE 802.1q IEEE 802.1w , IEEE 802.1x
Switch Properties	Store and forward, L2 wire-speed/non-blocking switching engine Number of queues per port : 8 MAC address : 8K Jumbo frames : 9K Bytes
Interface	Copper RJ45 Ports : 10/100/1000 Mbps speed auto-negotiation, MDI/MDIX Auto-crossover Fiber port : SFP slots , 100/1000BaseFX Console debug port Indicators : Indication of power input status, Ethernet port status Link & Speed
Network Redundancy	G-Ring supported , Link loss recovery < 20ms Spanning Tree Protocol : IEEE 802.1d STP, IEEE 802.1w RSTP, IEEE 802.1s MSTP Ring-Coupling, Dual-Homing, Chain, Balancing-Chain supported
User interfaces	Cisco-like CLI (command line interface) WEB-based Management SNMP v1, v2c, v3 Telnet (5 sessions)
VLANs	256 Port-based VLANs IEEE 802.1q tag-based VLANs IEEE 802.1ad Double Tagging(Q in Q)
QoS	IEEE 802.1p QoS, Policy/profile-based ACL Number of queues per port : 8 , Scheduling schemes : SPQ+WRR
Multicast protocols	IGMP v1, v2 and v3 with up to 255 multicast groups MVR
LACP	Network redundant LACP
LLDP	IEEE 802.1ab LLDP
Flow control	IEEE 802.3x (Full Duplex) and Back-Pressure(Half Duplex)
DHCP	Server, Client, Relay, Snooping, Option82
SNTP	Yes
Security	Multicast/Broadcast/Flooding Storm Control on per port and per VLAN basis IP and MAC-based Access control; Policy-based Access control IEEE 802.1X authentication Network Access Control HTTPS, SSH
Upgrade & Restore	WEB for Configuration Import/Export WEB for Firmware Upgrade
Diagnostic	Syslog Per VLAN mirroring Ethernet Copper connection diagnostic tool SFP DDM
MIB	RFC 1757 RMON 1, 2, 3, 9 RFC 2674 Q-bridge MIB RFC-1213 MIB-II RFC-1493 bridge MIB RFC 2233 IF MIB

Power	Power input : DC12V-DC58V Max. 298.7mA @ DC24V, Max. 7.17Watts Redundant Input Terminal Reverse power protection
Mechanical	Fan-less design , IP40 protection , metal housing Dimension : 154mm(H) x 60mm (W) x 109mm (D) Weight : 1056g Installation option : DIN-Rail mounting, Wall mounting
Environmental	Operating temperature : -40 ~ 75°C Storage temperature : -40 ~ 85°C Humidity : 5 ~ 95%RH ( non-condensing )
EMS	IEC61000-4-2 (ESD) ±6kV(contact), ±8kV(air) IEC61000-4-3 (RS) 10V/m (80MHz~2GHz) IEC61000-4-4 (EFT) Power Port: ±2kV, Data Port: ±1kV IEC61000-4-5 (Surge) Power Port: ±1kV/DM, ±2kV/CM, Data Port: ±2kV IEC61000-4-6 (CS) 10V (150kHz~80MHz)
EMI	FCC Part 15/CISPR22 (EN55022) Class A
Immunity	IEC61000-6-2
Mechanical standard	IEC60068-2-6 (Vibration) IEC60068-2-27 (Shock) IEC60068-2-32 (Freefall)
RoHS&WEEE	RoHS (Pb free), WEEE compliant
MTBF	>25 years
Certification	CE, FCC

## Order model

GIE5008-8T	8-ports RJ45 10/100BaseT(X) , managed switch
GIE5008-6T-2SFP	6-ports RJ45 10/100BaseT(X) , 2-ports 100/1000BaseFX SFP slot , managed switch
GIE5008-8GT	8-ports RJ45 10/100/1000BaseT(X) , Gigabit managed switch
GIE5008-6GT-2SFP	6-ports RJ45 10/100/1000BaseT(X) , 2-ports 100/1000BaseFX SFP slot , Gigabit managed switch

GIE

## Accessories

GSFP-SX-MM-0102I	Industrial Multi-mode 100Mbps 2KM Fiber Transceiver, LC typically for fiber, 850nm, -40~85°C
GSFP-SX-MM1-0102I	Industrial Multi-mode 100Mbps 2KM Fiber Transceiver, LC typically for fiber, 1310nm, -40~85°C
GSFP-LX-SM-0130I	Industrial Single-mode 100Mbps 30Km Fiber Transceiver, LC typically for fiber, 1310nm, -40~85°C
GSFP-SX-MM-0202I	Industrial 1000Base-SX+ multi-mode transceiver 2km, LC typically for fiber, 1310nm, -40~85°C
GSFP-LX-SM-0210I	Industrial 1000Base-LX single-mode transceiver 10Km, LC typically for fiber, 1310nm, -40~85°C
GSFP-LX-SM-0230I	Industrial 1000Base-LHX single-mode transceiver 30km, LC typically for fiber, 1310nm, -40~85°C

Remarks: the above SFP Transceivers are common modules, If there are other special specifications, please consult the customer service

## Product description

GIE5008 series are full Gigabit Ethernet switches, providing 8 Gigabit Ethernet ports to update the existing network to a full gigabit speed infrastructure. A full Gigabit network provides higher overall throughput than a legacy Fast Ethernet network, and reduce the response time for timing sensitive applications that may mix of video, voice and data in its traffic pipe. With the powerful features, GIE5008 series managed switches are easily to prioritize, partition and organize user's network and provide reliable and good quality services.

## Managed Switch

- 10-ports managed switch , Static routing, support the communication between different vlans
- Spanning tree STP, RSTP & MSTP, G-Ring fail -over protection (< 20 ms)
- VLAN, IGMP, DHCP, SNMP, QoS, ACL, HTTPS, SSH
- The ports with hardware ESD protection , MDI/MDIX Auto-crossover
- Support EtherNet/IP , ProfiNet , MODBUS TCP protocol
- Certification compliance : **CE** **FC**



### Specifications

Standards	IEEE 802.3 (10Base-T) , IEEE 802.3u (100Base-T) , IEEE 802.3ab (1000Base-T) , IEEE 802.3z (1000Base-X) IEEE 802.3x IEEE 802.1p IEEE 802.1q IEEE 802.1w , IEEE 802.1x
Switch Properties	Store and forward, L2 wire-speed/non-blocking switching engine Number of queues per port : 8 MAC address : 8K Jumbo frames : 9K Bytes
Interface	Copper RJ45 Ports : 10/100/1000 Mbps speed auto-negotiation, MDI/MDIX Auto-crossover Fiber port : SFP slots , 100/1000BaseFX Console debug port Indicators : Indication of power input status, Ethernet port status Link & Speed
Network Redundancy	G-Ring supported , Link loss recovery < 20ms Spanning Tree Protocol : IEEE 802.1d STP, IEEE 802.1w RSTP, IEEE 802.1s MSTP Ring-Coupling, Dual-Homing, Chain, Balancing-Chain supported
User interfaces	Cisco-like CLI (command line interface) WEB-based Management SNMP v1, v2c, v3 Telnet (5 sessions)
VLANs	256 Port-based VLANs IEEE 802.1q tag-based VLANs IEEE 802.1ad Double Tagging(Q in Q)
QoS	IEEE 802.1p QoS, Policy/profile-based ACL Number of queues per port : 8 , Scheduling schemes : SPQ+WRR
Multicast protocols	IGMP v1, v2 and v3 with up to 255 multicast groups MVR
LACP	Network redundant LACP
LLDP	IEEE 802.1ab LLDP
Flow control	IEEE 802.3x (Full Duplex) and Back-Pressure(Half Duplex)
DHCP	Server, Client, Relay, Snooping, Option82
SNTP	Yes
Security	Multicast/Broadcast/Flooding Storm Control on per port and per VLAN basis IP and MAC-based Access control; Policy-based Access control IEEE 802.1X authentication Network Access Control HTTPs, SSH
Upgrade & Restore	WEB for Configuration Import/Export WEB for Firmware Upgrade
Diagnostic	Syslog Per VLAN mirroring Ethernet Copper connection diagnostic tool SFP DDM
MIB	RFC 1757 RMON 1, 2, 3, 9 RFC 2674 Q-bridge MIB RFC-1213 MIB-II RFC-1493 bridge MIB RFC 2233 IF MIB

Power	Power input : DC12V-DC58V Max. 304.2mA @ DC24V, Max. 7.3Watts Redundant Input Terminal Reverse power protection
Mechanical	Fan-less design , IP40 protection , metal housing Dimension : 154mm(H) x 60mm (W) x 109mm (D) Weight : 1056g Installation option : DIN-Rail mounting, Wall mounting
Environmental	Operating temperature : -40 ~ 75°C Storage temperature : -40 ~ 85°C Humidity : 5 ~ 95%RH ( non-condensing )
EMS	IEC61000-4-2 (ESD) ±6kV(contact), ±8kV(air) IEC61000-4-3 (RS) 10V/m (80MHz~2GHz) IEC61000-4-4 (EFT) Power Port: ±2kV, Data Port: ±1kV IEC61000-4-5 (Surge) Power Port: ±1kV/DM, ±2kV/CM, Data Port: ±2kV IEC61000-4-6 (CS) 10V (150kHz~80MHz)
EMI	FCC Part 15/CISPR22 (EN55022) Class A
Immunity	IEC61000-6-2
Mechanical standard	IEC60068-2-6 (Vibration) IEC60068-2-27 (Shock) IEC60068-2-32 (Freefall)
RoHS&WEEE	RoHS (Pb free), WEEE compliant
MTBF	>25 years
Certification	CE, FCC

## Order model

GIE5010-10T	10-ports RJ45 10/100BaseT(X) , managed switch
GIE5010-8T-2SFP	8-ports RJ45 10/100BaseT(X) , 2-ports 100/1000BaseFX SFP slot , managed switch
GIE5010-6T-4SFP	6-ports RJ45 10/100BaseT(X) , 4-ports 100/1000BaseFX SFP slot , managed switch
GIE5010-10GT	10-ports RJ45 10/100/1000BaseT(X) , Gigabit managed switch
GIE5010-8GT-2SFP	8-ports RJ45 10/100/1000BaseT(X) , 2-ports 100/1000BaseFX SFP slot , Gigabit managed switch
GIE5010-6GT-4SFP	6-ports RJ45 10/100/1000BaseT(X) , 4-ports 100/1000BaseFX SFP slot , Gigabit managed switch

GIE

## Accessories

GSFP-SX-MM-0102I	Industrial Multi-mode 100Mbps 2KM Fiber Transceiver, LC typically for fiber, 850nm, -40~85°C
GSFP-SX-MM1-0102I	Industrial Multi-mode 100Mbps 2KM Fiber Transceiver, LC typically for fiber, 1310nm, -40~85°C
GSFP-LX-SM-0130I	Industrial Single-mode 100Mbps 30Km Fiber Transceiver, LC typically for fiber, 1310nm, -40~85°C
GSFP-SX-MM-0202I	Industrial 1000Base-SX+ multi-mode transceiver 2km, LC typically for fiber, 1310nm, -40~85°C
GSFP-LX-SM-0210I	Industrial 1000Base-LX single-mode transceiver 10Km, LC typically for fiber, 1310nm, -40~85°C
GSFP-LX-SM-0230I	Industrial 1000Base-LHX single-mode transceiver 30km, LC typically for fiber, 1310nm, -40~85°C

Remarks: the above SFP Transceivers are common modules, If there are other special specifications, please consult the customer service

## Product description

GIE5010 series are full Gigabit Ethernet switches, providing 8 Gigabit Ethernet ports to update the existing network to a full gigabit speed infrastructure. A full Gigabit network provides higher overall throughput than a legacy Fast Ethernet network, and reduce the response time for timing sensitive applications that may mix of video, voice and data in its traffic pipe. With the powerful features, GIE5010 series managed switches are easily to prioritize, partition and organize user's network and provide reliable and good quality services.



## Managed Switch

- 14-ports managed switch , Static routing, support the communication between different vlans
- Spanning tree STP, RSTP & MSTP, G-Ring fail -over protection (< 20 ms)
- VLAN, IGMP, DHCP, SNMP, QoS, ACL, HTTPS, SSH
- The ports with hardware ESD protection , MDI/MDIX Auto-crossover
- Support EtherNet/IP , ProfiNet , MODBUS TCP protocol
- Certification compliance : **CE FC**



### Specifications

Standards	IEEE 802.3 (10Base-T) , IEEE 802.3u (100Base-T) , IEEE 802.3ab (1000Base-T) , IEEE 802.3z (1000Base-X) IEEE 802.3x IEEE 802.1p IEEE 802.1q IEEE 802.1w , IEEE 802.1x
Switch Properties	Store and forward, L2 wire-speed/non-blocking switching engine Number of queues per port : 8 MAC address : 8K Jumbo frames : 9K Bytes
Interface	Copper RJ45 Ports : 10/100/1000 Mbps speed auto-negotiation, MDI/MDIX Auto-crossover Fiber port : SFP slots , 100/1000BaseFX Console debug port Indicators : Indication of power input status, Ethernet port status Link & Speed
Network Redundancy	G-Ring supported , Link loss recovery < 20ms Spanning Tree Protocol : IEEE 802.1d STP, IEEE 802.1w RSTP, IEEE 802.1s MSTP Ring-Coupling, Dual-Homing, Chain, Balancing-Chain supported
User interfaces	Cisco-like CLI (command line interface) WEB-based Management SNMP v1, v2c, v3 Telnet (5 sessions)
VLANs	256 Port-based VLANs IEEE 802.1q tag-based VLANs IEEE 802.1ad Double Tagging(Q in Q)
QoS	IEEE 802.1p QoS, Policy/profile-based ACL Number of queues per port: 8 , Scheduling schemes : SPQ+WRR
Multicast protocols	IGMP v1, v2 and v3 with up to 255 multicast groups MVR
LACP	Network redundant LACP
LLDP	IEEE 802.1ab LLDP
Flow control	IEEE 802.3x (Full Duplex) and Back-Pressure(Half Duplex)
DHCP	Server, Client, Relay, Snooping, Option82
SNTP	Yes
Security	Multicast/Broadcast/Flooding Storm Control on per port and per VLAN basis IP and MAC-based Access control; Policy-based Access control IEEE 802.1X authentication Network Access Control HTTPS, SSH
Upgrade & Restore	WEB for Configuration Import/Export WEB for Firmware Upgrade
Diagnostic	Syslog Per VLAN mirroring Ethernet Copper connection diagnostic tool SFP DDM
MIB	RFC 1757 RMON 1, 2, 3, 9 RFC 2674 Q-bridge MIB RFC-1213 MIB-II RFC-1493 bridge MIB RFC 2233 IF MIB

Power	Power input : DC12V-DC58V Max. 450mA @ DC24V, Max. 10.8Watts Redundant Input Terminal Reverse power protection
Mechanical	Fan-less design , IP40 protection , metal housing Dimension : 154mm(H) x 60mm (W) x 109mm (D) Weight : 1056g Installation option : DIN-Rail mounting, Wall mounting
Environmental	Operating temperature : -40 ~ 75°C Storage temperature : -40 ~ 85°C Humidity : 5 ~ 95%RH ( non-condensing )
EMS	IEC61000-4-2 (ESD) ±6kV(contact), ±8kV(air) IEC61000-4-3 (RS) 10V/m (80MHz~2GHz) IEC61000-4-4 (EFT) Power Port: ±2kV, Data Port: ±1kV IEC61000-4-5 (Surge) Power Port: ±1kV/DM, ±2kV/CM, Data Port: ±2kV IEC61000-4-6 (CS) 10V (150kHz~80MHz)
EMI	FCC Part 15/CISPR22 (EN55022) Class A
Immunity	IEC61000-6-2
Mechanical standard	IEC60068-2-6 (Vibration) IEC60068-2-27 (Shock) IEC60068-2-32 (Freefall)
RoHS&WEEE	RoHS (Pb free), WEEE compliant
MTBF	>25 years
Certification	CE, FCC

## Order model

GIE5014-10T-4SFP	10-ports RJ45 10/100BaseT(X) , 4-ports 100/1000BaseFX SFP slot , managed switch
GIE5014-10GT-4SFP	10-ports RJ45 10/100/1000BaseT(X) , 4-ports 100/1000BaseFX SFP slot , Gigabit managed switch

GIE

## Accessories

GSFP-SX-MM-0102I	Industrial Multi-mode 100Mbps 2KM Fiber Transceiver, LC typically for fiber, 850nm, -40~85°C
GSFP-SX-MM1-0102I	Industrial Multi-mode 100Mbps 2KM Fiber Transceiver, LC typically for fiber, 1310nm, -40~85°C
GSFP-LX-SM-0130I	Industrial Single-mode 100Mbps 30Km Fiber Transceiver, LC typically for fiber, 1310nm, -40~85°C
GSFP-SX-MM-0202I	Industrial 1000Base-SX+ multi-mode transceiver 2km, LC typically for fiber, 1310nm, -40~85°C
GSFP-LX-SM-0210I	Industrial 1000Base-LX single-mode transceiver 10Km, LC typically for fiber, 1310nm, -40~85°C
GSFP-LX-SM-0230I	Industrial 1000Base-LHX single-mode transceiver 30km, LC typically for fiber, 1310nm, -40~85°C

Remarks: the above SFP Transceivers are common modules, If there are other special specifications, please consult the customer service

## Product description

GIE5014 series are full Gigabit Ethernet switches, providing 8 Gigabit Ethernet ports to update the existing network to a full gigabit speed infrastructure. A full Gigabit network provides higher overall throughput than a legacy Fast Ethernet network, and reduce the response time for timing sensitive applications that may mix of video, voice and data in its traffic pipe. With the powerful features, GIE5014 series managed switches are easily to prioritize, partition and organize user's network and provide reliable and good quality services.

## Managed Switch

- 28-ports managed switch , Static routing, support the communication between different vlans
- Spanning tree STP, RSTP & MSTP, G-Ring fail -over protection (< 20 ms)
- VLAN, IGMP, DHCP, SNMP, QoS, ACL, HTTPS, SSH
- 1U 19" rack mounting
- Support EtherNet/IP , ProfiNet , MODBUS TCP protocol
- Certification compliance : **CE FC**



### Specifications

Standards	IEEE 802.3 (10Base-T) , IEEE 802.3u (100Base-T) , IEEE 802.3ab (1000Base-T) , IEEE 802.3z (1000Base-X) IEEE 802.3x IEEE 802.1p IEEE 802.1q IEEE 802.1w , IEEE 802.1x
Switch Properties	Store and forward, L2 wire-speed/non-blocking switching engine Number of queues per port : 8 MAC address : 8K Jumbo frames : 9K Bytes
Interface	Copper RJ45 Ports : 10/100/1000 Mbps speed auto-negotiation, MDI/MDIX Auto-crossover Fiber port : SFP slots , 100/1000BaseFX Console debug port Indicators : Indication of power input status, Ethernet port status Link & Speed, Indication of RR and RS Network Redundancy
Network Redundancy	G-Ring supported , Link loss recovery < 20ms Spanning Tree Protocol : IEEE 802.1d STP, IEEE 802.1w RSTP, IEEE 802.1s MSTP Ring-Coupling, Dual-Homing, Chain, Balancing-Chain supported
User interfaces	Cisco-like CLI (command line interface) WEB-based Management SNMP v1, v2c, v3 Telnet (5 sessions)
VLANs	2048 Port-based VLANs IEEE 802.1q tag-based VLANs IEEE 802.1ad Double Tagging(Q in Q)
QoS	IEEE 802.1p QoS, Policy/profile-based ACL Number of queues per port : 8, Scheduling schemes : SPQ+WRR
Multicast protocols	IGMP v1, v2 and v3 with up to 512 multicast groups MVR
LACP	Network redundant LACP
LLDP	IEEE 802.1ab LLDP
Flow control	IEEE 802.3x (Full Duplex) and Back-Pressure(Half Duplex)
DHCP	Server, Client, Relay, Snooping, Option82
SNTP	Yes
Security	Multicast/Broadcast/Flooding Storm Control on per port and per VLAN basis IP and MAC-based Access control; Policy-based Access control IEEE 802.1X authentication Network Access Control HTTPs, SSH
Upgrade & Restore	FTP for Configuration Import/Export FTP for Firmware Upgrade
Diagnostic	Syslog Per VLAN mirroring Ethernet Copper connection diagnostic tool SFP DDM
MIB	RFC 1757 RMON 1, 2, 3, 9 RFC 2674 Q-bridge MIB RFC-1213 MIB-II RFC-1493 bridge MIB RFC 2233 IF MIB

Power	Input power : AC110V-AC240V, Max. 114.5mA @ AC220V, Max. 25.2Watts Support over current protection Dual redundant power input with power cable
Mechanical	Fan-less design , IP30 protection , metal housing Dimension : 44mm(H) x 440mm (W) x 253mm (D) Weight : 3000g Installation option : 1U 19" rack mounting
Environmental	Operating temperature : -40 ~ 75°C Storage temperature : -40 ~ 85°C Humidity : 5 ~ 95%RH ( non-condensing )
EMS	IEC61000-4-2 (ESD) ±6kV(contact), ±8kV(air) IEC61000-4-3 (RS) 10V/m (80MHz~2GHz) IEC61000-4-4 (EFT) Power Port: ±2kV, Data Port: ±1kV IEC61000-4-5 (Surge) Power Port: ±1kV/DM, ±2kV/CM, Data Port: ±2kV IEC61000-4-6 (CS) 10V (150kHz~80MHz)
EMI	FCC Part 15/CISPR22 (EN55022) Class A
Immunity	IEC61000-6-2
Mechanical standard	IEC60068-2-6 (Vibration) IEC60068-2-27 (Shock) IEC60068-2-32 (Freefall)
RoHS&WEEE	RoHS (Pb free), WEEE compliant
MTBF	>25 years
Certification	CE, FCC

## Order model

GIE5128F-24T-4SFP	Front Access , 24-ports RJ45 10/100BaseT(X) , 4-ports 100/1000BaseFX SFP slot , managed switch
GIE5128F-24GT-4SFP	Front Access , 24-ports RJ45 10/100/1000BaseT(X) , 4-ports 100/1000BaseFX SFP slot , Gigabit managed switch

Remarks : the above model are front access, if you need rear access, please consult the customer service

GIE

## Accessories

GSFP-SX-MM-0102I	Industrial Multi-mode 100Mbps 2KM Fiber Transceiver, LC typically for fiber, 850nm, -40~85°C
GSFP-SX-MM1-0102I	Industrial Multi-mode 100Mbps 2KM Fiber Transceiver, LC typically for fiber, 1310nm, -40~85°C
GSFP-LX-SM-0130I	Industrial Single-mode 100Mbps 30Km Fiber Transceiver, LC typically for fiber, 1310nm, -40~85°C
GSFP-SX-MM-0202I	Industrial 1000Base-SX+ multi-mode transceiver 2km, LC typically for fiber, 1310nm, -40~85°C
GSFP-LX-SM-0210I	Industrial 1000Base-LX single-mode transceiver 10Km, LC typically for fiber, 1310nm, -40~85°C
GSFP-LX-SM-0230I	Industrial 1000Base-LHX single-mode transceiver 30km, LC typically for fiber, 1310nm, -40~85°C

Remarks: the above SFP Transceivers are common modules, If there are other special specifications, please consult the customer service

## Product description

GIE5128 is a full Gigabit, rack-mount type Ethernet switch, providing 28 Gigabit Ethernet ports to update the existing network to a full gigabit speed infrastructure. A full Gigabit network provides higher overall throughput than a legacy Fast Ethernet network, and reduce the response time for timing sensitive applications that may mix of video, voice and data in its traffic pipe. With the powerful features, GIE5128 managed switches are easily to prioritize, partition and organize user's network and provide reliable and good quality services.

## L3 Managed Switch

- 10-ports L3 Gigabit managed switch , Static routing, RIPv1/RIPv2, OSPF, VRRP
- Spanning tree STP, RSTP & MSTP, G-Ring fail -over protection (< 20 ms)
- VLAN, IGMP, DHCP, SNMP, QoS, ACL, HTTPS, SSH
- DIN-Rail mounting, ports designed Compact
- Support EtherNet/IP , ProfiNet , MODBUS TCP protocol
- Certification compliance : **CE FC**



### Specifications

Standards	IEEE 802.3 (10Base-T) , IEEE 802.3u (100Base-T) , IEEE 802.3ab (1000Base-T) , IEEE 802.3z (1000Base-X) IEEE 802.3x IEEE 802.1p IEEE 802.1q IEEE 802.1w , IEEE 802.1x
Switch Properties	Store and forward, L2/L3 wire-speed/non-blocking switching engine Number of queues per port : 8 MAC address : 8K Jumbo frames : 9K Bytes
Interface	Copper RJ45 Ports : 10/100/1000 Mbps speed auto-negotiation, MDI/MDIX Auto-crossover Fiber port : SFP slots , 1000BaseFX Console debug port Indicators : Indication of power input status, Ethernet port status Link & Speed
L3 routing	Static routing, RIPv1/RIPv2, OSPF VRRP
Network Redundancy	G-Ring supported , Link loss recovery < 20ms Spanning Tree Protocol : IEEE 802.1d STP, IEEE 802.1w RSTP, IEEE 802.1s MSTP Ring-Coupling, Dual-Homing, Chain, Balancing-Chain supported
User interfaces	Cisco-like CLI (command line interface) WEB-based Management SNMP v1, v2c, v3 Telnet (5 sessions)
VLANs	2048 Port-based VLANs IEEE 802.1q tag-based VLANs IEEE 802.1ad Double Tagging(Q in Q)
QoS	IEEE 802.1p QoS, Policy/profile-based ACL Number of queues per port: 8, Scheduling schemes : SPQ+WRR
Multicast protocols	IGMP v1, v2 and v3 with up to 256 multicast groups MVR
LACP	Network redundant LACP
LLDP	IEEE 802.1ab LLDP
Flow control	IEEE 802.3x (Full Duplex) and Back-Pressure(Half Duplex)
DHCP	Server, Client, Relay, Snooping, Option82
SNTP	Yes
Security	Multicast/Broadcast/Flooding Storm Control on per port and per VLAN basis IP and MAC-based Access control; Policy-based Access control IEEE 802.1X authentication Network Access Control HTTPs, SSH
Upgrade & Restore	FTP for Configuration Import/Export FTP for Firmware Upgrade
Diagnostic	Syslog Per VLAN mirroring Ethernet Copper connection diagnostic tool SFP DDM
MIB_1	RFC 1757 RMON 1, 2, 3, 9 RFC 2674 Q-bridge MIB

MIB_2	RFC-1213 MIB-II RFC-1493 bridge MIB RFC 2233 IF MIB
Power	Power input : DC12V-DC58V Max. 479.2mA @ DC24V, Max. 11.5Watts Redundant Input Terminal Reverse power protection
Mechanical	Fan-less design , IP40 protection , metal housing Dimension : 152mm(H) x 60mm (W) x 132.8mm (D) Weight : 1230g Installation option : DIN-Rail mounting, Wall mounting
Environmental	Operating temperature : -40 ~ 75°C Storage temperature : -40 ~ 85°C Humidity : 5 ~ 95%RH ( non-condensing )
EMS	IEC61000-4-2 (ESD) ±6kV(contact), ±8kV(air) IEC61000-4-3 (RS) 10V/m (80MHz~2GHz) IEC61000-4-4 (EFT) Power Port: ±2kV, Data Port: ±1kV IEC61000-4-5 (Surge) Power Port: ±1kV/DM, ±2kV/CM, Data Port: ±2kV IEC61000-4-6 (CS) 10V (150kHz~80MHz)
EMI	FCC Part 15/CISPR22 (EN55022) Class A
Immunity	IEC61000-6-2
Mechanical standard	IEC60068-2-6 (Vibration) IEC60068-2-27 (Shock) IEC60068-2-32 (Freefall)
RoHS&WEEE	RoHS (Pb free), WEEE compliant
MTBF	>25 years
Certification	CE, FCC

## Order model

GIE8010-6GT-2SFP-2C	DIN-Rail mounting , 6-ports RJ45 10/100/1000BaseT(X) , 2-ports 1000BaseFX SFP slot , 2-ports COMBO, L3 managed
---------------------	--

## Accessories

GSFP-SX-MM-0202I	Industrial 1000Base-SX+ multi-mode transceiver 2km, LC typically for fiber, 1310nm, -40~85°C
GSFP-LX-SM-0210I	Industrial 1000Base-LX single-mode transceiver 10Km, LC typically for fiber, 1310nm, -40~85°C
GSFP-LX-SM-0230I	Industrial 1000Base-LHX single-mode transceiver 30km, LC typically for fiber, 1310nm, -40~85°C

Remarks: the above SFP Transceivers are common modules, If there are other special specifications, please consult the customer service

## Product description

GIE8010 is DIN-Rail type L3 Ethernet Switch delivers high quality, wire-speed L2 switching & L3 routing performance, advanced features such as powerful VLAN operation, Police-based traffic manage & security, and intelligent management design, to fulfill different application scenario. It provides the scalability, flexibility & reliability for large network structure, and is also an ideal solution of L3 routing off-load for core network.

## L3 Managed Switch

- 28-ports L3 Gigabit managed switch , Static routing, RIPv1/RIPv2, OSPF, VRRP
- Spanning tree STP, RSTP & MSTP, G-Ring fail -over protection (< 20 ms)
- VLAN, IGMP, DHCP, SNMP, QoS, ACL, HTTPS, SSH
- 1U 19" rack mounting
- Support EtherNet/IP , ProfiNet , MODBUS TCP protocol
- Certification compliance : **CE FC**



### Specifications

Standards	IEEE 802.3 (10Base-T) , IEEE 802.3u (100Base-T) , IEEE 802.3ab (1000Base-T) , IEEE 802.3z (1000Base-X) IEEE 802.3x IEEE 802.1p IEEE 802.1q IEEE 802.1w , IEEE 802.1x
Switch Properties	Store and forward, L3 wire-speed/non-blocking switching engine Number of queues per port : 8 MAC address : 8K Jumbo frames : 9K Bytes
Interface	Copper RJ45 Ports : 10/100/1000 Mbps speed auto-negotiation, MDI/MDIX Auto-crossover Fiber port : SFP slots , 1000BaseFX Console debug port Indicators : Indication of power input status, Ethernet port status Link & Speed, Indication of RR and RS Network Redundancy
L3 routing	Static routing, RIPv1/RIPv2, OSPF VRRP
Network Redundancy	G-Ring supported , Link loss recovery < 20ms Spanning Tree Protocol : IEEE 802.1d STP, IEEE 802.1w RSTP, IEEE 802.1s MSTP Ring-Coupling, Dual-Homing, Chain, Balancing-Chain supported
User interfaces	Cisco-like CLI (command line interface) WEB-based Management SNMP v1, v2c, v3 Telnet (5 sessions)
VLANs	2048 Port-based VLANs IEEE 802.1q tag-based VLANs IEEE 802.1ad Double Tagging(Q in Q)
QoS	IEEE 802.1p QoS, Policy/profile-based ACL Number of queues per port: 8, Scheduling schemes : SPQ+WRR
Multicast protocols	IGMP v1, v2 and v3 with up to 256 multicast groups MVR
LACP	Network redundant LACP
LLDP	IEEE 802.1ab LLDP
Flow control	IEEE 802.3x (Full Duplex) and Back-Pressure(Half Duplex)
DHCP	Server, Client, Relay, Snooping, Option82
SNTP	Yes
Security	Multicast/Broadcast/Flooding Storm Control on per port and per VLAN basis IP and MAC-based Access control; Policy-based Access control IEEE 802.1X authentication Network Access Control HTTPS, SSH
Upgrade & Restore	FTP for Configuration Import/Export FTP for Firmware Upgrade
Diagnostic	Syslog Per VLAN mirroring Ethernet Copper connection diagnostic tool SFP DDM
MIB_1	RFC 1757 RMON 1, 2, 3, 9 RFC 2674 Q-bridge MIB

MIB_2	RFC-1213 MIB-II RFC-1493 bridge MIB RFC 2233 IF MIB
Power	Input power : AC110V-AC240V, Max. 114.5mA @ AC220V, Max. 25.2Watts Support over current protection Dual redundant power input with power cable
Mechanical	Fan-less design , IP30 protection , metal housing Dimension : 44mm(H) x 440mm (W) x 253mm (D) Weight : 3000g Installation option : 1U 19" rack mounting
Environmental	Operating temperature : -40 ~ 75°C Storage temperature : -40 ~ 85°C Humidity : 5 ~ 95%RH ( non-condensing )
EMS	IEC61000-4-2 (ESD) ±6kV(contact), ±8kV(air) IEC61000-4-3 (RS) 10V/m (80MHz~2GHz) IEC61000-4-4 (EFT) Power Port: ±2kV, Data Port: ±1kV IEC61000-4-5 (Surge) Power Port: ±1kV/DM, ±2kV/CM, Data Port: ±2kV IEC61000-4-6 (CS) 10V (150kHz~80MHz)
EMI	FCC Part 15/CISPR22 (EN55022) Class A
Immunity	IEC61000-6-2
Mechanical standard	IEC60068-2-6 (Vibration) IEC60068-2-27 (Shock) IEC60068-2-32 (Freefall)
RoHS&WEEE	RoHS (Pb free), WEEE compliant
MTBF	>25 years
Certification	CE, FCC

## Order model

GIE8128F-24GT-4SFP	Front Access , 24-ports RJ45 10/100/1000BaseT(X) , 4-ports 100/1000BaseFX SFP slot , L3 Gigabit managed switch
--------------------	--

Remarks : the above model are front access, if you need rear access, please consult the customer service

## Accessories

GSFP-SX-MM-0202I	Industrial 1000Base-SX+ multi-mode transceiver 2km, LC typically for fiber, 1310nm, -40~85°C
GSFP-LX-SM-0210I	Industrial 1000Base-LX single-mode transceiver 10Km, LC typically for fiber, 1310nm, -40~85°C
GSFP-LX-SM-0230I	Industrial 1000Base-LHX single-mode transceiver 30km, LC typically for fiber, 1310nm, -40~85°C

Remarks: the above SFP Transceivers are common modules, If there are other special specifications, please consult the customer service

## Product description

GIE8128 is L3 Ethernet Switch delivers high quality, wire-speed L3 routing performance, advanced features such as powerful VLAN operation, Police-based traffic manage & security, and intelligent management design, to fulfill different application scenario. It provides the scalability, flexibility & reliability for large network structure, and is also an ideal solution of L3 routing off-load for core network.



## Managed 10G Switch

- 28-ports managed 10G switch, up to 24 100/1000BaseSFP slots plus 4 10G SFP+ slots
- Spanning tree STP, RSTP & MSTP, G-Ring fail-over protection (< 20 ms)
- VLAN, IGMP, DHCP, SNMP, QoS, ACL, HTTPS, SSH
- 1U 19" rack mounting
- Support EtherNet/IP , ProfiNet , MODBUS TCP protocol
- Certification compliance : **CE FC**



### Specifications

Standards	IEEE 802.3 (10Base-T) , IEEE 802.3u (100Base-T) , IEEE 802.3ab (1000Base-T) , IEEE 802.3z (1000Base-X) IEEE 802.3x IEEE 802.1p IEEE 802.1q IEEE 802.1w , IEEE 802.1x
Switch Properties	Store and forward, L2 wire-speed/non-blocking switching engine Number of queues per port : 8 MAC address : 8K Jumbo frames : 9K Bytes
Interface	24个 Gigabit ports, 100/1000BaseSFP slots 4个 10G SFP slots Console debug port Indicators : Indication of power input status, Ethernet port status Link & Speed, Indication of RR and RS Network Redundancy
Network Redundancy	G-Ring supported , Link loss recovery < 20ms Spanning Tree Protocol : IEEE 802.1d STP, IEEE 802.1w RSTP, IEEE 802.1s MSTP Single & Multiple rings supported
User interfaces	Cisco-like CLI (command line interface) WEB-based Management SNMP v1, v2c, v3 Telnet (5 sessions)
VLANs	2048 Port-based VLANs IEEE 802.1q tag-based VLANs, IEEE 802.1v protocol-based VLANs IEEE 802.1ad Double Tagging(Q in Q), Private VLAN
QoS	IEEE 802.1p QoS, Policy/profile-based ACL Number of queues per port : 8 , Scheduling schemes : SPQ+WRR
Multicast protocols	IGMP v1, v2 and v3 with up to 512 multicast groups MVR
LACP	Network redundant LACP
LLDP	IEEE 802.1ab LLDP
Flow control	IEEE 802.3x (Full Duplex) and Back-Pressure(Half Duplex)
DHCP	Server, Client, Relay, Snooping, Option82
SNTP	Yes
Security	Multicast/Broadcast/Flooding Storm Control on per port and per VLAN basis IP and MAC-based Access control; Policy-based Access control IEEE 802.1X authentication Network Access Control HTTPS, SSH
Upgrade & Restore	FTP for Configuration Import/Export FTP for Firmware Upgrade
Diagnostic	Syslog Policy-based stream mirroring Ethernet Copper connection diagnostic tool SFP DDM
MIB	RFC 1757 RMON 1, 2, 3, 9 RFC 2674 Q-bridge MIB RFC-1213 MIB-II RFC-1493 bridge MIB RFC 2233 IF MIB

Power	Input power : AC110V-AC240V, Max. 44Watts Support over current protection Dual redundant power input with power cable
Mechanical	Fan-less design , IP30 protection , metal housing Dimension : 44mm(H) x 440mm (W) x 318.3mm (D) Weight : 4500g Installation option : 1U 19" rack mounting
Environmental	Operating temperature : -40 ~ 75°C Storage temperature : -40 ~ 85°C Humidity : 5 ~ 95%RH ( non-condensing )
EMS	IEC61000-4-2 (ESD) ±6kV(contact), ±8kV(air) IEC61000-4-3 (RS) 10V/m (80MHz~2GHz) IEC61000-4-4 (EFT) Power Port: ±2kV, Data Port: ±1kV IEC61000-4-5 (Surge) Power Port: ±1kV/DM, ±2kV/CM, Data Port: ±2kV IEC61000-4-6 (CS) 10V (150kHz~80MHz)
EMI	FCC Part 15/CISPR22 (EN55022) Class A
Immunity	IEC61000-6-2
Mechanical standard	IEC60068-2-6 (Vibration) IEC60068-2-27 (Shock) IEC60068-2-32 (Freefall)
RoHS&WEEE	RoHS (Pb free), WEEE compliant
MTBF	>25 years
Certification	CE, FCC

Order model

GIE6128F-24SFP4X	Front Access , 24-ports 100/1000BaseSFP slots , 4-ports 10G SFP slots , Managed 10G Ethernet Switch
------------------	---

Remarks : the above model are front access, if you need rear access, please consult the customer service

GIE

Accessories

GSFP-RJ45-02	Industrial SFP RJ45, 1000Mbps, -40~85°C
GSFP-SX-MM-0202I	Industrial 1000Base-SX+ multi-mode transceiver 2km, LC typically for fiber, 1310nm, -40~85°C
GSFP-LX-SM-0210I	Industrial 1000Base-LX single-mode transceiver 10Km, LC typically for fiber, 1310nm, -40~85°C
GSFP-LX-SM-0230I	Industrial 1000Base-LHX single-mode transceiver 30km, LC typically for fiber, 1310nm, -40~85°C
GSFP-ER-SM-0340I	Industrial 10G SFP+ single-mode transceiver 40km, LC typically for fiber, 1310nm, -40~85°C

Remarks: the above SFP Transceivers are common modules, If there are other special specifications, please consult the customer service

Product description

GIE6128F-24SFP4X is rack-mount type Ethernet switches, equipped with 4 10G ports & 24 Gigabit Ethernet ports. With flexible combination of copper and fiber port options, provide high overall throughput, and reduce the response time for timing sensitive applications that may mix of video, voice and data in its traffic pipe. With the powerful features, managed switches are easily to prioritize, partition and organize user's network and provide reliable and good quality services.

## L3 Managed 10G Switch

- 28-ports L3 managed 10G switch, up to 24 100/1000BaseSFP slots plus 4 10G SFP+ slots
- Static routing, RIPv1/RIPv2, OSPF, VRRP, Spanning tree STP, RSTP & MSTP, G-Ring fail-over protection (< 20 ms)
- VLAN, IGMP, DHCP, SNMP, QoS, ACL, HTTPS, SSH
- 1U 19" rack mounting
- Support EtherNet/IP , ProfiNet , MODBUS TCP protocol
- Certification compliance : **CE FC**



### Specifications

Standards	IEEE 802.3 (10Base-T) , IEEE 802.3u (100Base-T) , IEEE 802.3ab (1000Base-T) , IEEE 802.3z (1000Base-X) IEEE 802.3x IEEE 802.1p IEEE 802.1q IEEE 802.1w , IEEE 802.1x
Switch Properties	Store and forward, L3 wire-speed/non-blocking switching engine Number of queues per port : 8 MAC address : 8K Jumbo frames : 9K Bytes
Interface	24个 Gigabit ports, 100/1000BaseSFP slots 4个 10G SFP slots Console debug port Indicators : Indication of power input status, Ethernet port status Link & Speed, Indication of RR and RS Network Redundancy
L3 routing	Static routing, RIPv1/RIPv2, OSPF VRRP
Network Redundancy	G-Ring supported , Link loss recovery < 20ms Spanning Tree Protocol : IEEE 802.1d STP, IEEE 802.1w RSTP, IEEE 802.1s MSTP Single & Multiple rings supported
User interfaces	Cisco-like CLI (command line interface) WEB-based Management SNMP v1, v2c, v3 Telnet (5 sessions)
VLANs	2048 Port-based VLANs IEEE 802.1q tag-based VLANs, IEEE 802.1v protocol-based VLANs IEEE 802.1ad Double Tagging(Q in Q), Private VLAN
QoS	IEEE 802.1p QoS, Policy/profile-based ACL Number of queues per port: 8, Scheduling schemes : SPQ+WRR
Multicast protocols	IGMP v1, v2 and v3 with up to 512 multicast groups MVR
LACP	Network redundant LACP
LLDP	IEEE 802.1ab LLDP
Flow control	IEEE 802.3x (Full Duplex) and Back-Pressure(Half Duplex)
DHCP	Server, Client, Relay, Snooping, Option82
SNTP	Yes
Security	Multicast/Broadcast/Flooding Storm Control on per port and per VLAN basis IP and MAC-based Access control; Policy-based Access control IEEE 802.1X authentication Network Access Control HTTPS, SSH
Upgrade & Restore	FTP for Configuration Import/Export FTP for Firmware Upgrade
Diagnostic	Syslog Policy-based stream mirroring Ethernet Copper connection diagnostic tool SFP DDM
MIB_1	RFC 1757 RMON 1, 2, 3, 9 RFC 2674 Q-bridge MIB

MIB_2	RFC-1213 MIB-II RFC-1493 bridge MIB RFC 2233 IF MIB
Power	Input power : AC110V-AC240V, Max. 44Watts Support over current protection Dual redundant power input with power cable
Mechanical	Fan-less design , IP30 protection , metal housing Dimension : 44mm(H) x 440mm (W) x 318.3mm (D) Weight : 4500g Installation option : 1U 19" rack mounting
Environmental	Operating temperature : -40 ~ 75°C Storage temperature : -40 ~ 85°C Humidity : 5 ~ 95%RH ( non-condensing )
EMS	IEC61000-4-2 (ESD) ±6kV(contact), ±8kV(air) IEC61000-4-3 (RS) 10V/m (80MHz~2GHz) IEC61000-4-4 (EFT) Power Port: ±2kV, Data Port: ±1kV IEC61000-4-5 (Surge) Power Port: ±1kV/DM, ±2kV/CM, Data Port: ±2kV IEC61000-4-6 (CS) 10V (150kHz~80MHz)
EMI	FCC Part 15/CISPR22 (EN55022) Class A
Immunity	IEC61000-6-2
Mechanical standard	IEC60068-2-6 (Vibration) IEC60068-2-27 (Shock) IEC60068-2-32 (Freefall)
RoHS&WEEE	RoHS (Pb free), WEEE compliant
MTBF	>25 years
Certification	CE, FCC

## Order model

GIE9128F-24SFP4X	Front Access , 24个100/1000BaseSFP slots , 4个10G SFP slots , L3 Managed 10G Ethernet Switch
------------------	--

Remarks : the above model are front access, if you need rear access, please consult the customer service

## Accessories

GSFP-RJ45-02	Industrial SFP RJ45, 1000Mbps, -40~85°C
GSFP-SX-MM-0202I	Industrial 1000Base-SX+ multi-mode transceiver 2km, LC typically for fiber, 1310nm, -40~85°C
GSFP-LX-SM-0210I	Industrial 1000Base-LX single-mode transceiver 10Km, LC typically for fiber, 1310nm, -40~85°C
GSFP-LX-SM-0230I	Industrial 1000Base-LHX single-mode transceiver 30km, LC typically for fiber, 1310nm, -40~85°C
GSFP-ER-SM-0340I	Industrial 10G SFP+ single-mode transceiver 40km, LC typically for fiber, 1310nm, -40~85°C

Remarks: the above SFP Transceivers are common modules, If there are other special specifications, please consult the customer service

## Product description

GIE9128F-24SFP4X is rack-mount type Ethernet switches, equipped with 4 10G ports & 24 Gigabit Ethernet ports. With flexible combination of copper and fiber port options, delivers high quality, wire-speed L3 routing performance, advanced features such as powerful VLAN operation, Police-based traffic manage & security, and intelligent management design, to fulfill different application scenario. It provides the scalability, flexibility & reliability for large network structure, and is also an ideal solution of L3 routing off-load for core network.

## PoE unmanaged Switch

- 5-ports PoE Gigabit unmanaged switch , can be used to power IEEE 802.3af/at standard devices (PD)
- IEEE 802.3at 30W / IEEE 802.3af 15.4W
- Operating temperature -40 to +75°C (cold startup at -40°C) ,
- Input voltage rang DC48V-DC58V , Redundant Input Terminals, Reverse power protection
- Enable/Disable broadcast storm protection
- Certification compliance : **CE FC**



### Specifications

Standards	IEEE 802.3 (10Base-T) , IEEE 802.3u (100Base-T) , IEEE 802.3ab (1000Base-T) , IEEE 802.3z (1000Base-X) IEEE 802.3af , IEEE 802.3at , IEEE 802.3x , IEEE 802.1p
Switch Properties	Store and forward, L2-wire-speed/non-blocking switching engine Number of queues per port : 4 MAC address : 2K Jumbo frames : 9K Bytes
Interface	PoE ports : IEEE 802.3af 15.4W / IEEE 802.3at 30W High Power PoE Copper RJ45 Ports : 10/100/1000 Mbps speed auto-negotiation, MDI/MDIX Auto-crossover Fiber port : SFP slots , 100/1000BaseFX DIP switches : Enable/Disable broadcast storm protection, Enable/Disable Power Alarm Indicators : Indication of power input status, Ethernet port status PoE & Link & Speed
Power	Power input : 54-58VDC for PoE+ , 48-58VDC for PoE Max. 3Watts ( without PD ) , Max. 120.2Watts ( with PD ) for 4-ports Scheduling, power control, PoE PD power consumption monitoring, Redundant Input Terminal, Reverse power protection
Mechanical	Fan-less design , IP40 protection , metal housing Dimension : 139mm(H) x 29mm (W) x 107mm (D) Weight : 469g Installation option : DIN-Rail mounting, Wall mounting
Environmental	Operating temperature : -40 ~ 75°C Storage temperature : -40 ~ 85°C Humidity : 5 ~ 95%RH ( non-condensing )
EMS	IEC61000-4-2 (ESD) ±6kV(contact), ±8kV(air) IEC61000-4-3 (RS) 10V/m (80MHz~2GHz) IEC61000-4-4 (EFT) Power Port: ±2kV, Data Port: ±1kV IEC61000-4-5 (Surge) Power Port: ±1kV/DM, ±2kV/CM, Data Port: ±2kV IEC61000-4-6 (CS) 10V (150kHz~80MHz)
EMI	FCC Part 15/CISPR22 (EN55022) Class A
Immunity	IEC61000-6-2
Mechanical standard	IEC60068-2-6 (Vibration) IEC60068-2-27 (Shock) IEC60068-2-32 (Freefall)
RoHS&WEEE	RoHS (Pb free), WEEE compliant
MTBF	>25 years
Certification	CE, FCC

### Order model

GIE3005PL-4P1GT	4-ports 10/100/1000BaseT(X) PoE , 1-port 10/100/1000BaseT(X) None PoE , PoE unmanaged
GIE3005PL-4P-SFP	4-ports 10/100/1000BaseT(X) PoE , 1-port 100/1000BaseFX , SFP slot , PoE unmanaged

### Accessories

GSFP-SX-MM-0202I	Industrial 1000Base-SX+ multi-mode transceiver 2km, LC typically for fiber, 1310nm, -40~85°C
GSFP-LX-SM-0210I	Industrial 1000Base-LX single-mode transceiver 10Km, LC typically for fiber, 1310nm, -40~85°C
GSFP-LX-SM-0230I	Industrial 1000Base-LHX single-mode transceiver 30km, LC typically for fiber, 1310nm, -40~85°C

Remarks: the above SFP Transceivers are common modules, If there are other special specifications, please consult the customer service

- 8/12/14-ports PoE Gigabit managed switch , IEEE 802.3af/at standard devices (PD)
- IEEE 802.3af 15.4W / IEEE 802.3at 30W High Power PoE
- Spanning tree STP, RSTP & MSTP, G-Ring fail -over protection (< 20 ms)
- VLAN, IGMP, DHCP, SNMP, QoS, ACL, HTTPS, SSH
- The ports with hardware ESD protection
- Certification compliance : **CE FC**



#### Specifications

Standards	IEEE 802.3i (10Base-T) , IEEE 802.3u (100Base-T) , IEEE 802.3ab (1000Base-T) , IEEE 802.3z (1000Base-X) IEEE 802.3af , IEEE 802.3at IEEE 802.3x IEEE 802.1p IEEE 802.1q IEEE 802.1w , IEEE 802.1x
Switch Properties	Store and forward, L2 wire-speed/non-blocking switching engine Number of queues per port : 8 MAC address : 8K Jumbo frames : 9K Bytes
Interface	PoE ports : IEEE 802.3af 15.4W / IEEE 802.3at 30W High Power PoE Copper RJ45 Ports : 10/100/1000 Mbps speed auto-negotiation, MDI/MDIX Auto-crossover Fiber port : SFP slots , 100/1000BaseFX Indicators : Indication of power input status, Ethernet port status PoE & Link & Speed, and RR and RS Network Redundancy Console debug port Alarm relay output
Network Redundancy	G-Ring supported , Link loss recovery < 20ms Spanning Tree Protocol : IEEE 802.1d STP, IEEE 802.1w RSTP, IEEE 802.1s MSTP Ring-Coupling, Dual-Homing, Chain, Balancing-Chain supported
User interfaces	Cisco-like CLI (command line interface) WEB-based Management SNMP v1, v2c, v3 Telnet (5 sessions)
VLANs	1024 Port-based VLANs, MAC-based VLANs IP Subnet-based VLANs Protocol-based VLANs IEEE 802.1q tag-based VLANs RADIUS-assigned VLAN IEEE 802.1ad Double Tagging(Q in Q)
QoS	Number of queues per port: 8 IEEE 802.1p QoS Scheduling schemes : SPQ+WRR Port-based shaping RADIUS-assigned QoS Class
Multicast protocols	IGMP v1, v2 and v3 with up to 255 multicast groups
LACP	Network redundant LACP
LLDP	IEEE 802.1ab LLDP
Flow control	IEEE 802.3x (Full Duplex) and Back-Pressure(Half Duplex)
DHCP	Server, Client, Relay, Snooping, Option82
SNTP	Yes
Security	Multicast/Broadcast/Flooding Storm Control on per port and per VLAN basis IP and MAC-based Access control; Policy-based Access control IEEE 802.1X authentication Network Access Control HTTPs, SSH
Upgrade & Restore	FTP for Configuration Import/Export FTP for Firmware Upgrade

## PoE managed Switch

Diagnostic	Syslog Per VLAN mirroring Ethernet Copper connection diagnostic tool SFP DDM
MIB	RFC 1757 RMON 1, 2, 3, 9 RFC 2674 Q-bridge MIB RFC-1213 MIB-II RFC-1493 bridge MIB RFC 2233 IF MIB
Power	Power input : 54-58VDC for PoE+ , 48-58VDC for PoE Max. 14W without PD connected, Max 265W with 240W PSE power delivered Scheduling, power control, PoE PD power consumption monitoring Redundant Input Terminal, Reverse power protection
Mechanical	Fan-less design , IP40 protection , metal housing Dimension : 154mm(H) x 77mm (W) x 128mm (D) Weight : 1410g Installation option : DIN-Rail mounting, Wall mounting
Environmental	Operating temperature : -40 ~ 75°C Storage temperature : -40 ~ 85°C Humidity : 5 ~ 95%RH ( non-condensing )
EMS	IEC61000-4-2 (ESD) ±6kV(contact), ±8kV(air) IEC61000-4-3 (RS) 10V/m (80MHz~2GHz) IEC61000-4-4 (EFT) Power Port: ±2kV, Data Port: ±1kV IEC61000-4-5 (Surge) Power Port: ±1kV/DM, ±2kV/CM, Data Port: ±2kV IEC61000-4-6 (CS) 10V (150kHz~80MHz)
EMI	FCC Part 15/CISPR22 (EN55022) Class A
Immunity	IEC61000-6-2
Mechanical standard	IEC60068-2-6 (Vibration) IEC60068-2-27 (Shock) IEC60068-2-32 (Freefall)
RoHS&WEEE	RoHS (Pb free), WEEE compliant
MTBF	>25 years
Certification	CE, FCC

### Order model

GIE5008PL-4P4GT	4-ports 10/100/1000BaseT(X) PoE , 4-ports 10/100/1000BaseT(X) None PoE , Managed
GIE5008PL-4P2GT-2SFP	4-ports 10/100/1000BaseT(X) PoE , 2-ports 10/100/1000BaseT(X) None PoE , 2-ports 100/1000BaseFX SFP slot , Managed
GIE5012PL-8P-4SFP	8-ports 10/100/1000BaseT(X) PoE , 4-ports 100/1000BaseFX SFP slot , Managed
GIE5014PL-8P2GT-4SFP	8-ports 10/100/1000BaseT(X) PoE , 2-ports 10/100/1000BaseT(X) None PoE , 4-ports 100/1000BaseFX SFP slot , Managed

### Accessories

GSFP-SX-MM-0202I	Industrial 1000Base-SX+ multi-mode transceiver 2km, LC typically for fiber, 1310nm, -40~85°C
GSFP-LX-SM-0210I	Industrial 1000Base-LX single-mode transceiver 10Km, LC typically for fiber, 1310nm, -40~85°C
GSFP-LX-SM-0230I	Industrial 1000Base-LHX single-mode transceiver 30km, LC typically for fiber, 1310nm, -40~85°C

Remarks: the above SFP Transceivers are common modules, If there are other special specifications, please consult the customer service

### Product description

GIE5000PL series are PoE Managed Gigabit Ethernet switch, providing 8 10/100/1000BaseT PoE PSE ports and 4 100/1000BaseSFP ports. It complies to IEEE 802.3at standard and able to deliver up to 30 watts power per port along with data on standard Ethernet cabling. The switch can be used to power any IEEE 802.3af/at compliant PoE PD devices with PoE power management feature, which eases the deployment effort of planning PoE power budget and eliminates the need for additional wiring to reach power source.

- 4-ports PROFINET Switch , PROFINET Conformance Class B
- MRP ( Media Redundancy Protocol )
- The GSDML file can be configured in SIMATIC STEP7 and Portal
- PROFINET Real-Time communication
- The ports with hardware ESD protection , MDI/MDIX Auto-crossover
- Certification compliance : 



Specifications

Standards	IEEE 802.3 (10Base-T) , IEEE 802.3u (100Base-T) IEEE 802.3x , IEEE 802.1p
Managed functions	Support SIMATIC STEP7 and Portal The GSDML file can be configured, the PROFINET switch can be found in the siemens hardware catalog under By calling up the object properties, you have to assign the PROFINET-Switch a unique PROFINET name in the project and check the IP address for plausibility. The PROFINET-Switch supports the optional media redundancy protocol (MRP) via ports 1 + 2 as MRP client. WEB MRP Client LLDP, DCP, SNMP SNTP Telnet, SSH
PROFINET interfaces	PROFINET IO as defined in IEC 61158-6-10 -- Physical layer Ethernet -- Transmission rate 100 Mbps, full duplex , Connection 4 x RJ45, integrated switch -- Features Media redundancy protocol (MRP) Port 1+2 , Automatic addressing/topology detection (LLDP, DCP)
Interfaces	FCN : Function button establish a connection with the portal server RST : Reset button for restarting the router
LED display	Power: Off - No power supply or device defective On - Device is correctly supplied with voltage RUN : Flashing light - The device starts On - The device is ready to operate BF : On - The device has no configuration and/or there is no connection to the PROFINET controller SF : On - A PROFINET diagnosis is available RJ45 LEDs : Green (Link) - Connected, Orange (Act) - Data transfer at the network
Power	Power input : DC24V (18-30VDC) , Max. 250mA @ DC24V, Reverse power protection
Mechanical	Fan-less design , IP20 protection Dimension : 76mm(H) x 59mm (W) x 32mm (D) Weight : 130g Installation option : DIN-Rail mounting
Environmental	Operating temperature : -40 ~ 75°C Storage temperature : -40 ~ 85°C Humidity : 5 ~ 95%RH ( non-condensing )
EMS	IEC61000-4-2 (ESD) ±6kV(contact), ±8kV(air) IEC61000-4-3 (RS) 10V/m (80MHz~2GHz) IEC61000-4-4 (EFT) Power Port: ±2kV, Data Port: ±1kV IEC61000-4-5 (Surge) Power Port: ±1kV/DM, ±2kV/CM, Data Port: ±2kV IEC61000-4-6 (CS) 10V (150kHz~80MHz)
EMI	FCC Part 15/CISPR22 (EN55022) Class A
Immunity	IEC61000-6-2
Mechanical standard	IEC60068-2-6 (Vibration) IEC60068-2-27 (Shock) IEC60068-2-32 (Freefall)
RoHS&WEEE	RoHS (Pb free), WEEE compliant
MTBF	>25 years
Certification	CE

Order model

GIE7004PN-4T	4-ports PROFINET Switch , MRP Client , Managed
--------------	--



## PROFINET Switch

- 8-ports PROFINET Switch , PROFINET Conformance Class B
- MRP ( Media Redundancy Protocol )
- The GSDML file can be configured in SIMATIC STEP7 and Portal
- PROFINET Real-Time communication
- The ports with hardware ESD protection , MDI/MDIX Auto-crossover
- Certification compliance : 



### Specifications

Standards	IEEE 802.3 (10Base-T) , IEEE 802.3u (100Base-T) IEEE 802.3x , IEEE 802.1p
Managed functions	Support SIMATIC STEP7 and Portal The GSDML file can be configured, the PROFINET switch can be found in the siemens hardware catalog under By calling up the object properties, you have to assign the PROFINET-Switch a unique PROFINET name in the project and check the IP address for plausibility. The PROFINET-Switch supports the optional media redundancy protocol (MRP) via ports 1 + 2 as MRP client. WEB MRP Client LLDP, DCP, SNMP SNTP Telnet, SSH
PROFINET interfaces	FINET IO as defined in IEC 61158-6-10 -- Physical layer Ethernet -- Transmission rate 100 Mbps, full duplex , Connection 4 x RJ45, integrated switch -- Features Media redundancy protocol (MRP) Port 1+2 , Automatic addressing/topology detection (LLDP, DCP)
Interfaces	FCN : Function button establish a connection with the portal server RST : Reset button for restarting the router
LED display	Power: Off - No power supply or device defective On - Device is correctly supplied with voltage RUN : Flashing light - The device starts On - The device is ready to operate BF : On - The device has no configuration and/or there is no connection to the PROFINET controller SF : On - A PROFINET diagnosis is available RJ45 LEDs : Green (Link) - Connected, Orange (Act) - Data transfer at the network
Power	Power input : DC24V (18-30VDC) , Max. 300mA @ DC24V, Reverse power protection
Mechanical	Fan-less design , IP20 protection Dimension : 76mm(H) x 82mm (W) x 32mm (D) Weight : 180g Installation option : DIN-Rail mounting
Environmental	Operating temperature : -40 ~ 75°C Storage temperature : -40 ~ 85°C Humidity : 5 ~ 95%RH ( non-condensing )
EMS	IEC61000-4-2 (ESD) ±6kV(contact), ±8kV(air) IEC61000-4-3 (RS) 10V/m (80MHz~2GHz) IEC61000-4-4 (EFT) Power Port: ±2kV, Data Port: ±1kV IEC61000-4-5 (Surge) Power Port: ±1kV/DM, ±2kV/CM, Data Port: ±2kV IEC61000-4-6 (CS) 10V (150kHz~80MHz)
EMI	FCC Part 15/CISPR22 (EN55022) Class A
Immunity	IEC61000-6-2
Mechanical standard	IEC60068-2-6 (Vibration) IEC60068-2-27 (Shock) IEC60068-2-32 (Freefall)
RoHS&WEEE	RoHS (Pb free), WEEE compliant
MTBF	>25 years
Certification	CE



### Order model

GIE7008PN-8T	8-ports PROFINET Switch , MRP Client , Managed
--------------	--

- 10/100BaseT(X), 4-pin M12 D-code, F/H duplex mode, and auto MDI/MDI-X connection
- Operating Temperature -40~75°C , IP67 rated housing protection
- Support EtherNet/IP , ProfiNet , MODBUS TCP protocol
- Input voltage rang DC9V-DC36V
- The EN 50155, EN50121-3-2 certification
- Certification compliance : **CE FC**

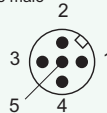

Specifications

Standards	IEEE 802.3 (10Base-T) IEEE 802.3u (100Base-T) IEEE 802.3x IEEE 802.1p EN50155 , EN50121-3-2
Switch Properties	Store and forward, L2-wire-speed/non-blocking switching engine Number of queues per port : 4 MAC address : 2K
Interface	5-ports M12 D-code : 10/100 Mbps speed auto-negotiation, MDI/MDIX Auto-crossover Power : M12 A-coding port Indicators : Indication of power input status, Ethernet port status Link & Speed
Power	Power input : DC9V-DC36V Max. 0.1A @ DC24V , Max. 2.4Watts Reverse power protection
Mechanical	Fan-less design IP67 protection , PA6 housing Dimension : 42.8mm(H) x 40mm (W) x 188mm (L) Weight : 290g Installation option : Wall mounting
Environmental	Operating temperature : -40 ~ 75°C Storage temperature : -40 ~ 85°C Humidity : 5 ~ 95%RH ( non-condensing )
EMS	IEC61000-4-2 (ESD) ±6kV(contact), ±8kV(air) IEC61000-4-3 (RS) 10V/m (80MHz~2GHz) IEC61000-4-4 (EFT) Power Port: ±2kV, Data Port: ±1kV IEC61000-4-5 (Surge) Power Port: ±1kV/DM, ±2kV/CM, Data Port: ±2kV IEC61000-4-6 (CS) 10V (150kHz~80MHz)
EMI	FCC Part 15/CISPR22 (EN55022) Class A
Immunity	IEC61000-6-2
Mechanical standard	IEC60068-2-6 (Vibration) IEC60068-2-27 (Shock) IEC60068-2-32 (Freefall)
MTBF	>25 years
Certification	CE, FCC
Connector	<div style="display: flex; justify-content: space-around;"> <div style="text-align: center;"> <p>M12 A-code male</p>  <p>1.BN 24V+ 2.WH 3.BU V- 4.BK 5.GN/YE</p> </div> <div style="text-align: center;"> <p>M12 D-code Female</p>  <p>1.Yellow(+Tx) 2.White(+Rx) 3.Orange(-Tx) 4.Blue(-Rx)</p> </div> </div>

Order model

GIE3305-5T	5-ports 10/100BaseT(X) M12 D-coding , IP67 rated housing protection , Unmanaged Switch
------------	--

Product description

GIE3305-5T Ethernet switches is IP67-rated for tough industrial applications. By using M12 connectors, you can rest assured that Ethernet cables will connect tightly to the switch, and will be robust enough to protect your applications from external disturbances, such as the vibration and shock encountered in the transportation industry.

## Media Converter

- 1-ports RJ45 10/100BaseT(X) , 1-port 100BaseFX SC typically for fiber
- LFF (Link Fault Forwarding)
- Support EtherNet/IP , ProfiNet , MODBUS TCP protocol
- Input voltage rang 12-48 VDC , Redundant Input Terminal
- Multi-Mode (2KM) and Single-Mode (20KM)
- Certification compliance : **CE FC**



### Specifications

Standards	IEEE 802.3 (10Base-T) , IEEE 802.3u (100Base-T) , IEEE 802.3x , IEEE 802.1p
Switch Properties	Store and forward, wire-speed/non-blocking switching engine
LFF	LFF (Link Fault Forwarding)
Interface	Copper RJ45 Ports : 10/100 Mbps speed auto-negotiation, MDI/MDIX Auto-crossover Fiber port : 100BaseFX ports (SC connector, multi-mode or single-mode), 1310nm Indicators : Indication of power input status, Ethernet port status Link & Speed DIP switches : Enable/Disable LFF (Link Fault Forwarding)
DIP	DIP1 : ON is disable LFF mode, OFF is enable LFF mode DIP2 : ON is Ethernet speed 10Mbps, OFF is Ethernet speed 100Mbps DIP3 : ON is Ethernet Half-duplex, OFF is Ethernet Full-duplex DIP4 : ON is Fiber Half-duplex, OFF is Fiber Full-duplex
Indicator	Power indicator, Green : Power LED x 2 (ON: power input on-line / (OFF) power input off-line 10/100Base-T(X) RJ 45 port indicator, Green for port Link/Act -(ON) Link up / (Blinking) Acting / (OFF) Link down 100Base-FX fiber port indicator, Green for fiber port Link/Act - (ON) Link up / (Flash) Acting / (OFF) Link down LFP statue indicator, Amber LED - (ON) LFP function fail / (OFF) LFP function disable
Power	Power input : DC12V-DC48V Max. 2.2Watts Redundant Input Terminal Reverse power protection
Mechanical	Fan-less design , IP30 protection , metal housing Dimension : 95mm(H) x 26mm (W) x 70mm (D) Weight : 218g Installation option : DIN-Rail mounting
Environmental	Operating temperature : -40 ~ 75°C Storage temperature : -40 ~ 85°C Humidity : 5 ~ 95%RH ( non-condensing )
EMS	IEC61000-4-2 (ESD) ±6kV(contact), ±8kV(air) IEC61000-4-3 (RS) 10V/m (80MHz~2GHz) IEC61000-4-4 (EFT) Power Port: ±2kV, Data Port: ±1kV IEC61000-4-5 (Surge) Power Port: ±1kV/DM, ±2kV/CM, Data Port: ±2kV IEC61000-4-6 (CS) 10V (150kHz~80MHz)
EMI	FCC Part 15/CISPR22 (EN55022) Class A
Immunity	IEC61000-6-2
Mechanical standard	IEC60068-2-6 (Vibration) IEC60068-2-27 (Shock) IEC60068-2-32 (Freefall)
RoHS&WEEE	RoHS (Pb free), WEEE compliant
MTBF	>25 years
Certification	CE, FCC

### Order model

GIE1002-T-M	1-ports RJ45 10/100BaseT(X) , 1-port 100BaseFX SC typically for fiber , Multi-Mode (2KM) , 1310nm , media converter
GIE1002-T-S	1-ports RJ45 10/100BaseT(X) , 1-port 100BaseFX SC typically for fiber , Single-Mode (30KM), 1310nm , media converter

### Product description

GIE1002 series is the best cost-effective solution for industrial applications, providing copper and fiber connectivity based on field needs. It is designed for supporting standard industrial applications without complex setup to make the network truly plug-and-play. With its compact design, GIE1002 series is perfectly fit for the field-site applications.

- 2-ports RJ45 10/100BaseT(X) , 1-port 100BaseFX LC typically for fiber
- LFPT (Link Fault Pass-Through)
- Support EtherNet/IP , ProfiNet , MODBUS TCP protocol
- Input voltage rang 12-58 VDC , Redundant Input Terminal
- Multi-Mode (2KM) and Single-Mode (20KM)
- Certification compliance : **CE FCC**



## Specifications

Standards	IEEE 802.3 (10Base-T) , IEEE 802.3u (100Base-T) , IEEE 802.3x , IEEE 802.1p
Switch Properties	Store and forward, wire-speed/non-blocking switching engine MAC address : 1K
Interface	Copper RJ45 Ports : 10/100 Mbps speed auto-negotiation, MDI/MDIX Auto-crossover Fiber port : 100BaseFX ports (LC connector, multi-mode or single-mode), 1310nm DIP switches : Enable/Disable broadcast storm protection, Enable/Disable Power Alarm Indicators : Indication of power input status, Ethernet port status Link & Speed
LFPT	Link Fault Pass-Through
Power	Power input : DC12V-DC58V Max. 2.8Watts Redundant Input Terminal Reverse power protection
Mechanical	Fan-less design , IP40 protection , metal housing Dimension : 109.2mm(H) x 29.1mm (W) x 89.4mm (D) Weight : 290g Installation option : DIN-Rail mounting, Wall mounting
Environmental	Operating temperature : -40 ~ 75°C Storage temperature : -40 ~ 85°C Humidity : 5 ~ 95%RH ( non-condensing )
EMS	IEC61000-4-2 (ESD) ±6kV(contact), ±8kV(air) IEC61000-4-3 (RS) 10V/m (80MHz~2GHz) IEC61000-4-4 (EFT) Power Port: ±2kV, Data Port: ±1kV IEC61000-4-5 (Surge) Power Port: ±1kV/DM, ±2kV/CM, Data Port: ±2kV IEC61000-4-6 (CS) 10V (150kHz~80MHz)
EMI	FCC Part 15/CISPR22 (EN55022) Class A
Immunity	IEC61000-6-2
Mechanical standard	IEC60068-2-6 (Vibration) IEC60068-2-27 (Shock) IEC60068-2-32 (Freefall)
RoHS&WEEE	RoHS (Pb free), WEEE compliant
MTBF	>25 years
Certification	CE, FCC

GIE

## Order model

GIE1003-2T-LC2	2-ports RJ45 10/100BaseT(X) , 1-port 100BaseFX LC typically for fiber , Multi-Mode (2KM) , 1310nm , media converter
GIE1003-2T-LC20	2-ports RJ45 10/100BaseT(X) , 1-port 100BaseFX LC typically for fiber , Single-Mode (20KM), 1310nm , media converter

## Product description

GIE1003 series is the best cost-effective solution for industrial applications, providing copper and fiber connectivity based on field needs. It is designed for supporting standard industrial applications without complex setup to make the network truly plug-and-play. With its compact design, GIE1003 series is perfectly fit for the field-site applications.



# Industrial VPN Router

# F



**B.C.E. s.r.l.**  
Via Regina Pacis, 54/c - 41049 SASSUOLO (MO) Italy  
Tel. +39 0536 811.616 r.a. - Fax +39 0536 811.500  
[www.bce.it](http://www.bce.it) - E-mail: [bce@bce.it](mailto:bce@bce.it)



- 3G/ LTE Industrial Router , Standard SIM, 1.8 V/3 V
- GSM/ GPRS/ EDGE/ UMTS/ HSPA/ DCS
- VPN : OpenVPN
- Highest Data transfer rates : LTE (Upload 50Mbps, Download 100Mbps)
- Router functions : Firewall, NAT/PAT, SMS wake-up
- Certification: 



## Specifications

Model	GRE01 3G	GRE01 LTE
VPN	OpenVPN	
Router functions	Firewall, NAT/PAT, SMS wake-up	
GSM modem	Quad-band GPRS/EDGE data interface	Multiband GSM/GPRS/WCDMA/LTE data interface
Antenna terminal	SMA socket (exterior thread)	
SIM card type	Standard SIM, 1.8 V/3 V	
GSM frequency bands	GSM/ GPRS/ EDGE : 850, 900, 1800, 1900	GSM900, DCS1800
UMTS frequency bands	UMTS/ HSPA : 800/850, 900, AWS 1700, 1900, 2100 class 1	B5(850), B8(900), B1(2100)
LTE frequency bands	-	B20(800), B3(1800), B7(2600)
Transmit power	Class 1, E2, 3, 4	
Data transfer rates	HSPA+ (Upload : 5.76Mbps , Download : 21.0Mbps)	HSPA+ (Upload : 5.76Mbps , Download : 42.0Mbps) LTE (Upload : 50Mbps , Download : 100Mbps)
Interfaces	Four 10/100 Mbps LAN ports USB 2.0 Type A port FCN : Function button establish a connection with the portal server , RST : Reset button for restarting the router	
LED display	PWR : Indicator light for the power supply , RDY : Readiness indicator (this LED must show a solid light after a max. of 110 s) CON Off: There is no active Internet or VPN connection Solid light: Internet connection active or possible, but VPN connection inactive Rapid flashing (3 Hz): The router is attempting to establish a VPN connection Flashing (1.5 Hz): VPN connection is active USR : Solid light: When loading default settings, firmware files, or device configurations	
Voltage	24 V (DC), as per DIN EN 61131-2 Type 2	
Mechanical	Fan-less design , IP20 protection , DIN-Rail mounting Dimension : 76mm(H) x 59mm (W) x 35mm (D) Weight : 130g	
Environmental	Operating temperature : -40 ~ 75°C Storage temperature : -40 ~ 85°C Humidity : 5 ~ 95%RH ( non-condensing )	
EMS	IEC61000-4-2 (ESD) ±6kV(contact), ±8kV(air) IEC61000-4-3 (RS) 10V/m (80MHz~2GHz) IEC61000-4-4 (EFT) Power Port: ±2kV, Data Port: ±1kV IEC61000-4-5 (Surge) Power Port: ±1kV/DM, ±2kV/CM, Data Port: ±2kV IEC61000-4-6 (CS) 10V (150kHz~80MHz)	
EMI	FCC Part 15/CISPR22 (EN55022) Class A	
Immunity	IEC61000-6-2	
Mechanical standard	IEC60068-2-6 (Vibration) IEC60068-2-27 (Shock) IEC60068-2-32 (Freefall)	
RoHS&WEEE	RoHS (Pb free), WEEE compliant	
MTBF	>25 years	
Certification	CE, UL	

## Order model

GRE01 3G	Industrial VPN Ethernet-Router, 4x LAN (Switch) / 1x 3G Modem,
GRE01 LTE	Industrial VPN Ethernet-Router, 4x LAN (Switch) / 1x LTE Modem (EU-& Asia-Version)
GRE01 ANT32	Magnetic base antenna, indoor, GSM/UMTS/LTE, 3.5 m cable, SMA socket

- WIFI/ WAN Industrial Router
- WIFI Router WLAN : IEEE802.11b/g & 802.11n(1T1R mode)
- VPN : OpenVPN
- Highest Data transfer rates : 802.11n(1T1R mode) to 150Mbps
- Router functions : Firewall, NAT/PAT, SNAT
- Certification: 



## Specifications

Model	GRE01 WIFI	GRE01 WAN
VPN	OpenVPN	
Router functions	Firewall, NAT/PAT, SNAT	
WLAN standards	IEEE802.11b/g & 802.11n (1T1R mode) , to 150Mbps	-
Antenna terminal	SMA plug (exterior thread)	-
WLAN specification	EU (2.412GHz-2.472GHz , 1-13 channels) USA (2.412GHz-2.462GHz , 1-11 channels) WPA/WP2, 64/128/152 bit WEP 802.11b: 1, 2, 5.5, 11 Mbps 802.11g: 6, 9, 12, 18, 24, 36, 48, 54 Mbps 802.11n: (20MHz) MCS0-7, up to 72 Mbps 802.11n: (40MHz) MCS0-7, up to 150Mbps	-
Interfaces	1x WLAN 802.11b/g/n Four 10/100 Mbps LAN ports USB 2.0 Type A port FCN : Function button establish a connection with the portal server RST : Reset button for restarting the router	1x WAN 10/100 Mbps 3x LAN 10/100 Mbps
LED display	PWR : Indicator light for the power supply , RDY : Readiness indicator (this LED must show a solid light after a max. of 110 s) CON Off: There is no active Internet or VPN connection Solid light: Internet connection active or possible, but VPN connection inactive Rapid flashing (3 Hz): The router is attempting to establish a VPN connection Flashing (1.5 Hz): VPN connection is active USR : Solid light: When loading default settings, firmware files, or device configurations	
Voltage	24 V (DC), as per DIN EN 61131-2 Type 2	
Mechanical	Fan-less design , IP20 protection , DIN-Rail mounting Dimension : 76mm(H) x 59mm (W) x 35mm (D) Weight : 130g	
Environmental	Operating temperature : -40 ~ 75°C Storage temperature : -40 ~ 85°C Humidity : 5 ~ 95%RH ( non-condensing )	
EMS	IEC61000-4-2 (ESD) ±6kV(contact), ±8kV(air) IEC61000-4-3 (RS) 10V/m (80MHz~2GHz) IEC61000-4-4 (EFT) Power Port: ±2kV, Data Port: ±1kV IEC61000-4-5 (Surge) Power Port: ±1kV/DM, ±2kV/CM, Data Port: ±2kV IEC61000-4-6 (CS) 10V (150kHz~80MHz)	
EMI	FCC Part 15/CISPR22 (EN55022) Class A	
Immunity	IEC61000-6-2	
Mechanical standard	IEC60068-2-6 (Vibration) IEC60068-2-27 (Shock) IEC60068-2-32 (Freefall)	
RoHS&WEEE	RoHS (Pb free), WEEE compliant	
MTBF	>25 years	
Certification	CE, UL	

## Order model

GRE01 WIFI	Industrial VPN Ethernet-Router, 4x LAN (Switch) / 1x WIFI
GRE01 ANT01	Antenna for WLAN/Bluetooth 2.4 GHz magnetic base antenna, 5 dBi incl. 1.5 m cable
GRE01 WAN	Industrial VPN Ethernet-Router, 3x LAN (Switch) / 1x WAN port





**B.C.E. s.r.l.**  
Via Regina Pacis, 54/c - 41049 SASSUOLO (MO) Italy  
Tel. +39 0536 811.616 r.a. - Fax +39 0536 811.500  
[www.bce.it](http://www.bce.it) - E-mail: [bce@bce.it](mailto:bce@bce.it)



# Industrial Communication Attachment |



**B.C.E. s.r.l.**  
Via Regina Pacis, 54/c - 41049 SASSUOLO (MO) Italy  
Tel. +39 0536 811.616 r.a. - Fax +39 0536 811.500  
www.bce.it - E-mail: bce@bce.it



# Communication Connector

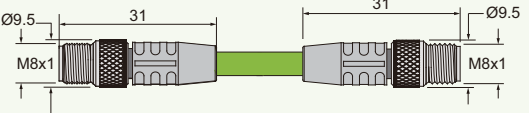
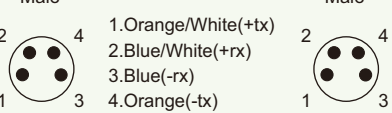
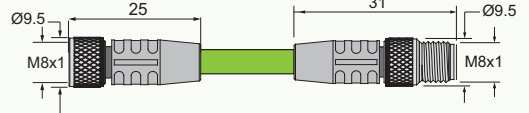
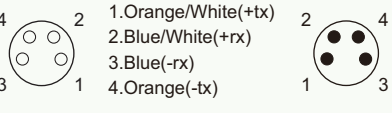
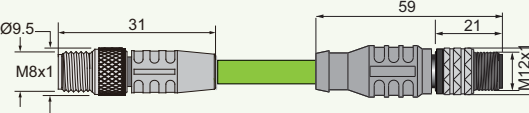
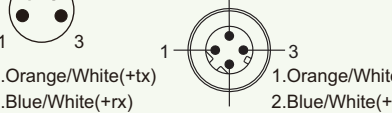
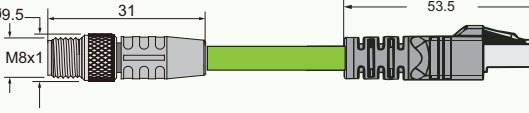
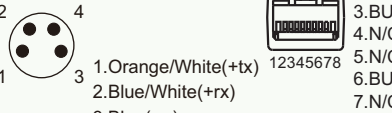

EtherCAT Connector	Order type	Pinout
<p>M8 Double end pre casting, straight Male-Male</p> 	<p>SIZ4 SIZ4-2M/F230 SIZ4 SIZ4-5M/F230 SIZ4 SIZ4-10M/F230 SIZ4 SIZ4-*M/F230</p>	<p>Male Male</p> 
<p>M8 Double end pre casting, straight Female-Male</p> 	<p>SIK4 SIZ4-2M/F230 SIK4 SIZ4-5M/F230 SIK4 SIZ4-10M/F230 SIK4 SIZ4-*M/F230</p>	<p>Female Male</p> 
<p>Double end pre casting, straight M8 Male-M12 Male ( D-coded )</p> 	<p>SIZ4 EIZ4-2M/F230 SIZ4 EIZ4-5M/F230 SIZ4 EIZ4-10M/F230 SIZ4 EIZ4-*M/F230</p>	<p>Male Male</p> 
<p>Double end pre casting, straight M8 Male-RJ45</p> 	<p>SIZ4 RJ45S-2M/F230 SIZ4 RJ45S-5M/F230 SIZ4 RJ45S-10M/F230 SIZ4 RJ45S-*M/F230</p>	<p>Male RJ45</p> 

\* Standard cable lengths are 2/5/10M, Consult factory for other lengths







PROFINET/EtherCAT Connector	Order type	Pinout
Double end pre casting, straight M12 Male-M12 Male 	EIZ4 EIZ4-2M/F21 EIZ4 EIZ4-5M/F21 EIZ4 EIZ4-10M/F21 EIZ4 EIZ4-*M/F21	Male(D-code)      Male(D-code) 
Double end pre casting, straight M12 Male-M12 Male Flexibility 	EIZ4 EIZ4-2M/F23 EIZ4 EIZ4-5M/F23 EIZ4 EIZ4-10M/F23 EIZ4 EIZ4-*M/F23	
Double end pre casting, straight M12 Male-RJ45 	EIZ4 RJ45S-2M/F21 EIZ4 RJ45S-5M/F21 EIZ4 RJ45S-10M/F21 EIZ4 RJ45S-*M/F21	Male(D-code) 
Double end pre casting, straight M12 Male-RJ45 Flexibility 	EIZ4 RJ45S-2M/F23 EIZ4 RJ45S-5M/F23 EIZ4 RJ45S-10M/F23 EIZ4 RJ45S-*M/F23	
Double end pre casting, straight M12 Male-RJ45(Quick Unlock ) 	EIZ4 SRJ45S-2M/F21 EIZ4 SRJ45S-5M/F21 EIZ4 SRJ45S-10M/21 EIZ4 SRJ45S-*M/F21	RJ45  12345678 1.YE 2.OR 3.WH 4.N/C 5.N/C 6.BU 7.N/C 8.N/C
Double end pre casting, straight M12 Male-RJ45(Quick Unlock) Flexibility 	EIZ4 SRJ45S-2M/F23 EIZ4 SRJ45S-5M/F23 EIZ4 SRJ45S-10M/23 EIZ4 SRJ45S-*M/F23	

\* Standard cable lengths are 2/5/10M, Consult factory for other lengths

ATT

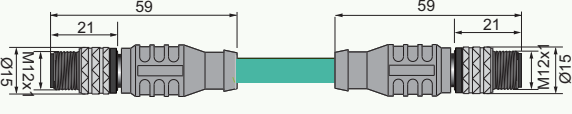
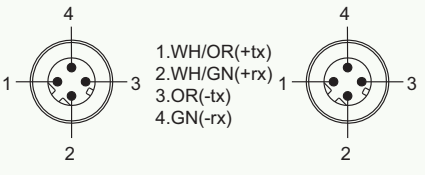
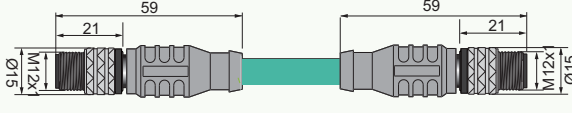
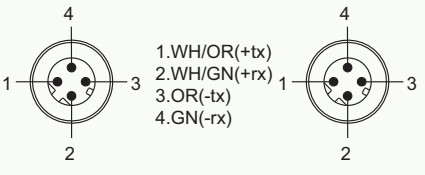
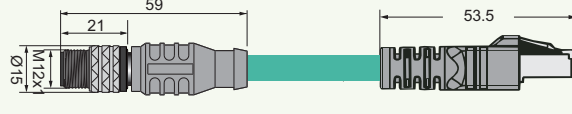
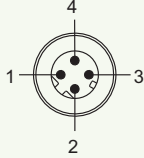
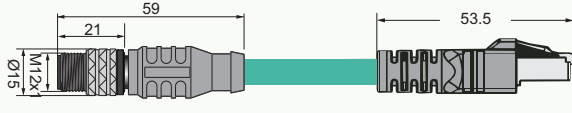
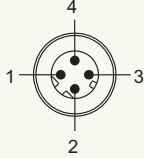
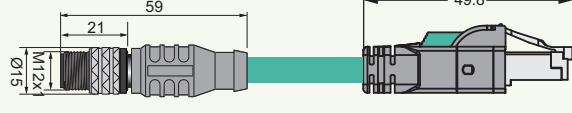
# Communication Connector

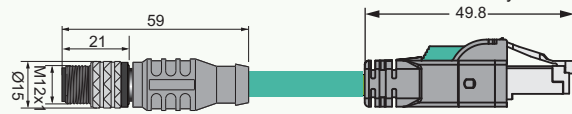

EtherNET/IP / Modbus TCP Connector	Order type	Pinout
<p>Double end pre casting, straight M12 Male-M12 Male</p> 	<p>EIZ4 EIZ4-2M/F41 EIZ4 EIZ4-5M/F41 EIZ4 EIZ4-10M/F41 EIZ4 EIZ4-*M/F41</p>	<p>Male(D-code)      Male(D-code)</p>  <p>1. WH/OR(+tx) 2. WH/GN(+rx) 3. OR(-tx) 4. GN(-rx)</p>
<p>Double end pre casting, straight M12 Male-M12 Male Flexibility</p> 	<p>EIZ4 EIZ4-2M/F410 EIZ4 EIZ4-5M/F410 EIZ4 EIZ4-10M/F410 EIZ4 EIZ4-*M/F410</p>	<p>Male(D-code)      Male(D-code)</p>  <p>1. WH/OR(+tx) 2. WH/GN(+rx) 3. OR(-tx) 4. GN(-rx)</p>
<p>Double end pre casting, straight M12 Male-RJ45</p> 	<p>EIZ4 RJ45S-2M/F41 EIZ4 RJ45S-5M/F41 EIZ4 RJ45S-10M/41 EIZ4 RJ45S-*M/F41</p>	<p>Male(D-code)</p>  <p>1. WH/OR(+tx) 2. WH/GN(+rx) 3. OR(-tx) 4. GN(-rx)</p>
<p>Double end pre casting, straight M12 Male-RJ45 Flexibility</p> 	<p>EIZ4 RJ45S-2M/F410 EIZ4 RJ45S-5M/F410 EIZ4 RJ45S-10M/F410 EIZ4 RJ45S-*M/F410</p>	<p>Male(D-code)</p>  <p>1. WH/OR(+tx) 2. WH/GN(+rx) 3. OR(-tx) 4. GN(-rx)</p>
<p>Double end pre casting, straight M12 Male-RJ45(Quick Unlock )</p> 	<p>EIZ4 SRJ45S-2M/F41 EIZ4 SRJ45S-5M/F41 EIZ4 SRJ45S-10M/41 EIZ4 SRJ45S-*M/F41</p>	<p>RJ45</p>  <p>1. WH/OR 2. OR 3. WH/GN 4. N/C 5. N/C 6. GN 7. N/C 8. N/C</p>
<p>Double end pre casting, straight M12 Male-RJ45(Quick Unlock) Flexibility</p> 	<p>EIZ4 SRJ45S-2M/F410 EIZ4 SRJ45S-5M/F410 EIZ4 SRJ45S-10M/F410 EIZ4 SRJ45S-*M/F410</p>	<p>RJ45</p>  <p>1. WH/OR 2. OR 3. WH/GN 4. N/C 5. N/C 6. GN 7. N/C 8. N/C</p>

\* Standard cable lengths are 2/5/10M, Consult factory for other lengths

ATT



Field connected Ethernet connector type	Order type	features	Pinout
M12 Straight, Male-D-code 	EK4238-0/9	4A, 250V, -40 ~ +85°C It can be butt welded with 4 pin D-coded, M12 pre cast receptacle connector	Male 
M12 Straight, Male-D-code 	EZ4238-0/9		Female 
M8x1 Straight, Male - Screw connection 	SK4218-0	PA6+GF/Black core insert, nickel plated copper shell PG7 Cable outlet The outer diameter range of the connecting cable : 3.5-5 mm Welding connection 85°C , 60V, 4 A	
M8x1 Straight, Male - Screw connection 	SZ4218-0		
RJ45 Straight , All metal , Movable joint 	RJ45/GHM	AWG22 Cable specification Outside diameter range of cable: 5.5-9 mm 70°C , 125V, 1.5 A 10/100Mbps	

# Communication Connector



PROFIBUS-DP Connector	Order type	Pinout
<p>Double end pre casting, straight M12 Female-M12 Male</p>	<p>EPK5 EPZ5-2M EPK5 EPZ5-5M EPK5 EPZ5-10M EPK5 EPZ5-*M</p>	<p>Female(B-code)</p> <p>Male(B-code)</p> <p>1=n.c 2=GN(Bus A) 3=n.c 4=RD(Bus B) 5=n.c</p>
<p>Double end pre casting, right-angle M12 Female-M12 Male</p>	<p>EPLK5 EPLZ5-2M EPLK5 EPLZ5-5M EPLK5 EPLZ5-10M EPLK5 EPLZ5-*M</p>	<p>Female(B-code)</p> <p>Male(D-code)</p> <p>1=n.c 2=GN(Bus A) 3=n.c 4=RD(Bus B) 5=n.c</p>
<p>Field connection live joint M12 Female</p>	<p>EK5228-0/9</p>	<p>Female(B-code)</p> <p>1=n.c 2=GN(Bus A) 3=n.c 4=RD(Bus B) 5=n.c</p>
<p>Field connection live joint M12 Male</p>	<p>EZ5228-0/9</p>	<p>Male(D-code)</p> <p>1=n.c 2=GN(Bus A) 3=n.c 4=RD(Bus B) 5=n.c</p>
<p>Profibus-DP Y-shaped</p>	<p>EPK5-2EPZ5-V</p>	<p>1xM12 Female</p> <p>2xM12 Male</p> <p>1=5VDC 2=Bus-A 3=GND 4=Bus-B 5=Shield</p>
<p>Profibus-DP terminal resistance</p>	<p>EPZ5-TR</p>	<p>1xM12 Male</p> <p>1=5VDC 2=Bus-A 3=GND 4=Bus-B 5=Shield</p>

\* Standard cable lengths are 2/5/10M, Consult factory for other lengths

ATT



DeviceNET Connector	Order type	Pinout
Straight M12 Female(A-code) 	ENK5-2M/10 ENK5-5M/10 ENK5-10M/10 ENK5-*M/10	
Straight M12 Male(A-code) 	ENLK5-2M/10 ENLK5-5M/10 ENLK5-10M/10 ENK5-*M/10	
Double end pre casting, straight M12 Female(A-code)-M12 Male(A-code) 	ENK5 ENZ5-2M/10 ENK5 ENZ5-5M/10 ENK5 ENZ5-10M/10 ENK5 ENZ5-*M/10	
Double end pre casting, right angle M12 Female(A-code)-M12 Male(A-code) 	ENLK5 ENLZ5-2M/10 ENLK5 ENLZ5-5M/10 ENLK5 ENLZ5-10M/10 ENLK5 ENLZ5-*M/10	
DeviceNET T type 	MNZ5-ENK5-MNK5	7/8"Male  7/8"Female  M12Female 
DeviceNET Terminating resistor M12x1Male M12x1Female 	ENZ5-TR ENK5-TR	M12Male  M12Female 

\* Standard cable lengths are 2/5/10M, Consult factory for other lengths

ATT



# Communication Connector



GXC series Connector	Order type	Pinout
<p>Double end pre casting, straight M8 Female-M8 Male</p>	<p>SIK4 SIZ4-0.3M/GXC                      SIK4 SIZ4-1M/GXC                      SIK4 SIZ4-2M/GXC                      SIK4 SIZ4-*M/GXC</p>	<p>M8Female</p> <p>M8Male</p> <p>1. Orange/White (Link+)                      2. Blue/White (RS485A)                      3. Orange (Link-)                      4. Blue (RS485B)</p>
<p>Double end pre casting, right angle M8 Female-M8 Male                      (For communication connections)</p>	<p>SIK4 EIZ4-0.5M/GXC                      SIK4 EIZ4-1M/GXC                      SIK4 EIZ4-2M/GXC                      SIK4 EIZ4-*M/GXC</p>	<p>M8Female</p> <p>M12Male</p> <p>1. Orange/White (Link+)                      2. Blue/White (RS485A)                      3. Orange (Link-)                      4. Blue (RS485B)</p>
<p>M8 Terminating resistor</p>	<p>SZ4-TR</p>	<p>M8Male</p> <p>120Ω                      1/4w</p> <p>1=NC                      2=RS485A                      3=NC                      4=RS485B</p>
<p>Straight M8 Female</p>	<p>SK4-2M/P00                      SK4-5M/P00                      SK4-10M/P00</p>	<p>M8Female</p> <p>1. BN                      2. WH                      3. BU                      4. BK</p>
<p>Straight M8 Male</p>	<p>SZ4-2M/P00                      SZ4-5M/P00                      SZ4-10M/P00</p>	<p>M8Male</p> <p>1. BN                      2. WH                      3. BU                      4. BK</p>
<p>Double end pre casting, straight M8 Female-M8 Male                      (For power connections)</p>	<p>SK4 SZ4-0.3M/P00                      SK4 SZ4-1M/P00                      SK4 SZ4-2M/P00                      SK4 SZ4-*M/P00</p>	<p>M8Female</p> <p>M8Male</p> <p>1. BN                      2. WH                      3. BU                      4. BK</p>







ATT

Power Connector	Order type	Pinout
<p>7/8" Straight 5pins Female</p>	<p>MK5-2M MK5-5M MK5-10M</p>	<p>1=BK (GND) 2=BU (GND) 3=GNYE (PE) 4=BN (U<sub>s</sub>) 5=WH (U<sub>a</sub>)</p>
<p>7/8" Straight 5pins Male</p>	<p>MZ5-2M MZ5-5M MZ5-10M</p>	<p>1=BK (GND) 2=BU (GND) 3=GNYE (PE) 4=BN (U<sub>s</sub>) 5=WH (U<sub>a</sub>)</p>
<p>Double end pre casting, 7/8" Straight 5pins Female-Male</p>	<p>MK5 MZ5-2M MK5 MZ5-5M MK5 MZ5-10M</p>	<p>1=BK (GND) 2=BU (GND) 3=GNYE (PE) 4=BN (U<sub>s</sub>) 5=WH (U<sub>a</sub>)</p>
<p>Power supply T type 5 pins</p>	<p>MZ5-2MK5</p>	<p>2x7/8"Female      1x7/8"Male</p> <p>1=BK (GND) 2=BU (GND) 3=GNYE (PE) 4=BN (U<sub>s</sub>) 5=WH (U<sub>a</sub>)</p>
<p>7/8" Straight 4pins Female</p>	<p>MK4-2M MK4-5M MK4-10M</p>	<p>1=RD 2=GN 3=WH 4=BK</p>
<p>7/8" Straight 4pins Male</p>	<p>MZ4-2M MZ4-5M MZ4-10M</p>	<p>1=RD 2=GN 3=WH 4=BK</p>
<p>Double end pre casting, 7/8" Straight 4pins Female-Male</p>	<p>MK4 MZ4-2M MK4 MZ4-5M MK4 MZ4-10M</p>	<p>1=RD 2=GN 3=WH 4=BK</p>
<p>Power supply T type 4 pins</p>	<p>MZ4-2MK4</p>	<p>2x7/8"Female      1x7/8"Male</p> <p>1=RD 2=GN 3=WH 4=BK</p>

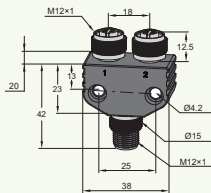
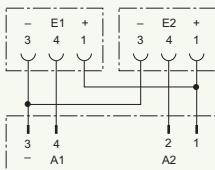
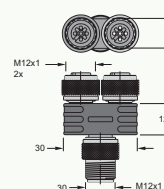
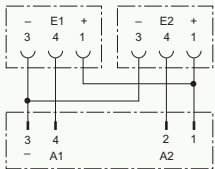
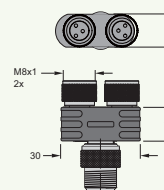
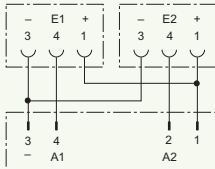
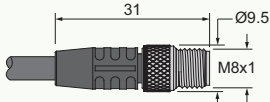

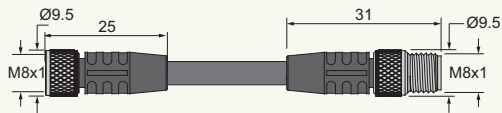

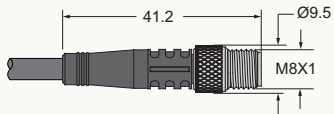
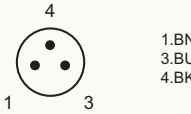
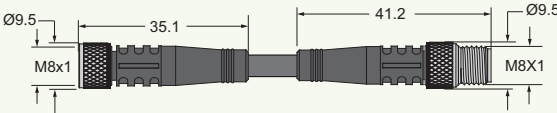
ATT

I/O Connector	Order type	Pinout
Double end pre casting, straight M12 Female- Male (3pins A-code) 	EK3 EZ3-2M/P00 EK3 EZ3-5M/P00 EK3 EZ3-10M/P00	
Double end pre casting, straight M12 Female- Male (4pins A-code) 	EK4 EZ4-2M/P00 EK4 EZ4-5M/P00 EK4 EZ4-10M/P00	
Double end pre casting, straight M12 Female- Male (5pins A-code) 	EK5 EZ5-2M/P00 EK5 EZ5-5M/P00 EK5 EZ5-10M/P00	
Straight M12 3pins Male A-code 	EZ3-2M/P00 EZ3-5M/P00 EZ3-10M/P00	
Straight M12 4pins Male A-code 	EZ4-2M/P00 EZ4-5M/P00 EZ4-10M/P00	
Splitter M12 4pins Male -2x 3pins M12 Female 	YZ4-2EK3-2M-2M/P00 YZ4-2EK3-5M-5M/P00 YZ4-2EK3-10M-10M/P00	
Splitter M12 4pins Male -2x 3pins M8 Female 	YZ4-2SK3-2M-2M/P00 YZ4-2SK3-5M-5M/P00 YZ4-2SK3-10M-10M/P00	
Splitter M12 4pins Male -2x 3pins M12 Female 	YWZ5-2M-2EK4.5-2M-2M/P00 YWZ5-5M-2EK4.5-5M-5M/P00	

ATT

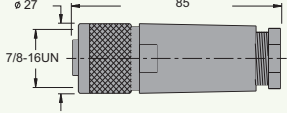
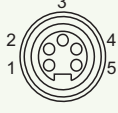
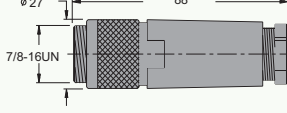
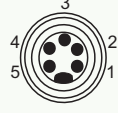
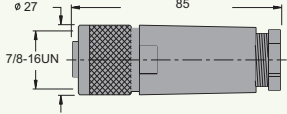
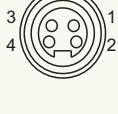
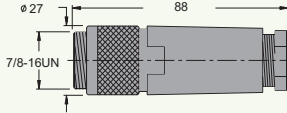
I/O Connector	Order type	Pinout
<p>Ø15 Locking nut Splitter</p> 	<p>YWZ4-2EK3</p>	
<p>Splitter</p> 	<p>YVZ4-2EK3</p>	
<p>Splitter</p> 	<p>YVZ4-2SK3</p>	
<p>Straight M8 Male Short</p> 	<p>SZD3-2M/P00 SZD3-5M/P00 SZD3-10M/P00</p>	<p>M8Male</p> 
<p>Double end pre casting, straight M8 3pins Female-Male Short</p> 	<p>SKD3 SZD3-2M/P00 SKD3 SZD3-5M/P00 SKD3 SZD3-10M/P00</p>	<p>M8Female      M8Male</p> 
<p>Straight M8 3pins Male</p> 	<p>SZ3-2M/P00 SZ3-5M/P00 SZ3-10M/P00</p>	<p>M8Male</p> 
<p>Double end pre casting, straight M8 3pins Female-Male</p> 	<p>SK3 SZ3-2M/P00 SK3 SZ3-5M/P00 SK3 SZ3-10M/P00</p>	<p>M8Female      M8Male</p> 

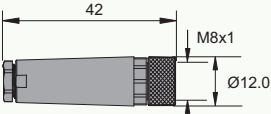
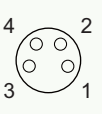
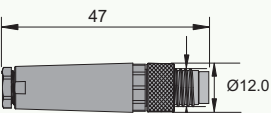
## Power Connector

Field connection connector	Features	Order type	Pinout
	7/8"straight female-5pins PA6+GF, black / copper zinc alloy PG11 cable outlet Cable diameter: 8-10mm Screw connection 85 C , 250V, 9 A	MK5211-0/11	
	7/8"straight female-5pins PA6+GF, black / copper zinc alloy PG13.5 cable outlet Cable diameter: 10-12mm Screw connection 85 C , 250V, 9 A	MK5211-0/13.5	
	7/8"straight male-5pins PA6+GF, black / copper zinc alloy PG11 cable outlet Cable diameter: 8-10mm Screw connection 85 C , 250V, 9 A	MZ5211-0/11	
	7/8"straight male-5pins PA6+GF, black / copper zinc alloy PG13.5 cable outlet Cable diameter: 10-12mm Screw connection 85 C , 250V, 9 A	MZ5211-0/13.5	
	7/8"straight female-4pins PA6+GF, black / copper zinc alloy PG11 cable outlet Cable diameter: 8-10mm Screw connection 85 C , 250V, 9 A	MK4211-0/11	
	7/8"straight male-4pins PA6+GF, black / copper zinc alloy PG11 cable outlet Cable diameter: 8-10mm Screw connection 85 C , 250V, 9 A	MZ4211-0/11	
	PA6+GF,black / copper zinc alloy M10 cable outlet Cable diameter: 3.5-5 mm Screw connection 85°C , 60V, 4 A	SK4212-0	
	PA6+GF,black / copper zinc alloy M10 cable outlet Cable diameter: 3.5-5 mm Screw connection 85°C , 60V, 4 A	SZ4212-0	

ATT

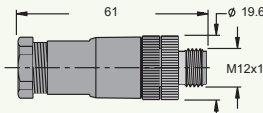
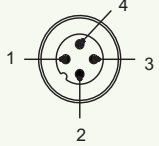
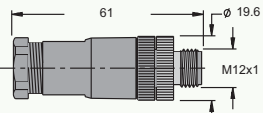
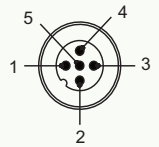
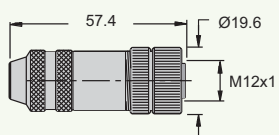
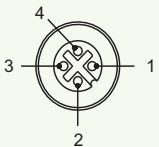
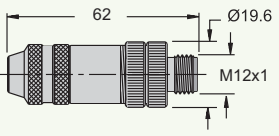
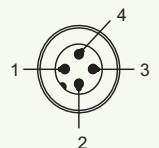
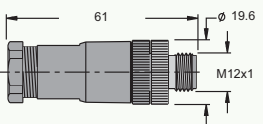
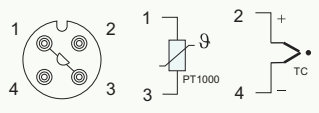
Field connection connector	Features	Order type	Pinout
	M12x1 straight male, A- coded 4pins PA6+GF, metal locking head PG7 cable outlet Cable diameter: 4-6mm Screw connection 85 C , 250V, 4A	EZ4112-0/7	
	M12x1 straight male, A- coded 4pins PA6+GF, metal locking head PG9 cable outlet Cable diameter: 6-8mm Screw connection 85 C , 250V, 4A	EZ4112-0/9	
	M12x1 straight male, A- coded 5pins PA6+GF, metal locking head PG7 cable outlet Cable diameter: 4-6mm Screw connection 85 C , 250V, 4A	EZ5112-0/7	
	M12x1 straight male, A- coded 5pins PA6+GF, metal locking head PG9 cable outlet Cable diameter: 6-8mm Screw connection 85 C , 250V, 4A	EZ5112-0/9	
	Nickel plating on brass Cable diameter: 6-8mm Core.MAX : 0.75 mm <sup>2</sup> Screw connection 85 C , 250V, 4A	EK4218-0/9	
	Nickel plating on brass Cable diameter: 6-8mm Core.MAX : 0.75 mm <sup>2</sup> Screw connection 85 C , 250V, 4A	EZ4218-0/9	
	M12x1 straight male, A- coded 4pins Built in compensation resistor for 1/3 pin PA6+GF, metal locking head PG7 cable outlet Cable diameter: 4-6mm Screw connection, 85 C , 250V, 4A	EZ4112-0/7-TC	

\* For more connector selection, refer to the industrial connector catalog

## SFP Transceiver Module

SFP transceiver-applicable Ethernet switch SFP slot	Features	Order type
	<p>Fast Multimode fiber LC type joint The wavelength is 850nm, 62.5/125um MMF Maximum distance 2km of optical fiber transmission Industrial grade, -40~85°C</p>	GSFP-SX-MM-01021
	<p>Fast Multimode fiber LC type joint The wavelength is 1310nm, 62.5/125um MMF Maximum distance 2km of optical fiber transmission Industrial grade, -40~85°C</p>	GSFP-SX-MM1-01021
	<p>Fast Single mode fiber LC type joint The wavelength is 1310nm, 9/125um SMF Maximum distance 30km of optical fiber transmission Industrial grade, -40~85°C</p>	GSFP-LX-SM-0130I
	<p>Gigabit Multimode fiber LC type joint The wavelength is 1310nm, 62.5/125um MMF Maximum distance 2km of optical fiber transmission Industrial grade, -40~85°C</p>	GSFP-SX-MM-0202I
	<p>Gigabit Single mode fiber LC type joint The wavelength is 1310nm, 9/125um SMF Maximum distance 10km of optical fiber transmission Industrial grade, -40~85°C</p>	GSFP-LX-SM-0210I
	<p>Gigabit Single mode fiber LC type joint The wavelength is 1310nm, 9/125um SMF Maximum distance 30km of optical fiber transmission Industrial grade, -40~85°C</p>	GSFP-LX-SM-0230I
	<p>10Gigabit Single mode fiber LC type joint The wavelength is 1310nm, 9/125um SMF Maximum distance 40km of optical fiber transmission Industrial grade, -40~85°C</p>	GSFP-ER-SM-0340I
	<p>Gigabit Copper SFP RJ45 Hot plug Maximum distance 100m of network transmission Industrial grade, -40~85°C</p>	GSFP-RJ45-02

\* the above SFP optical module is the normal model. If there are special specifications, please consult the customer service

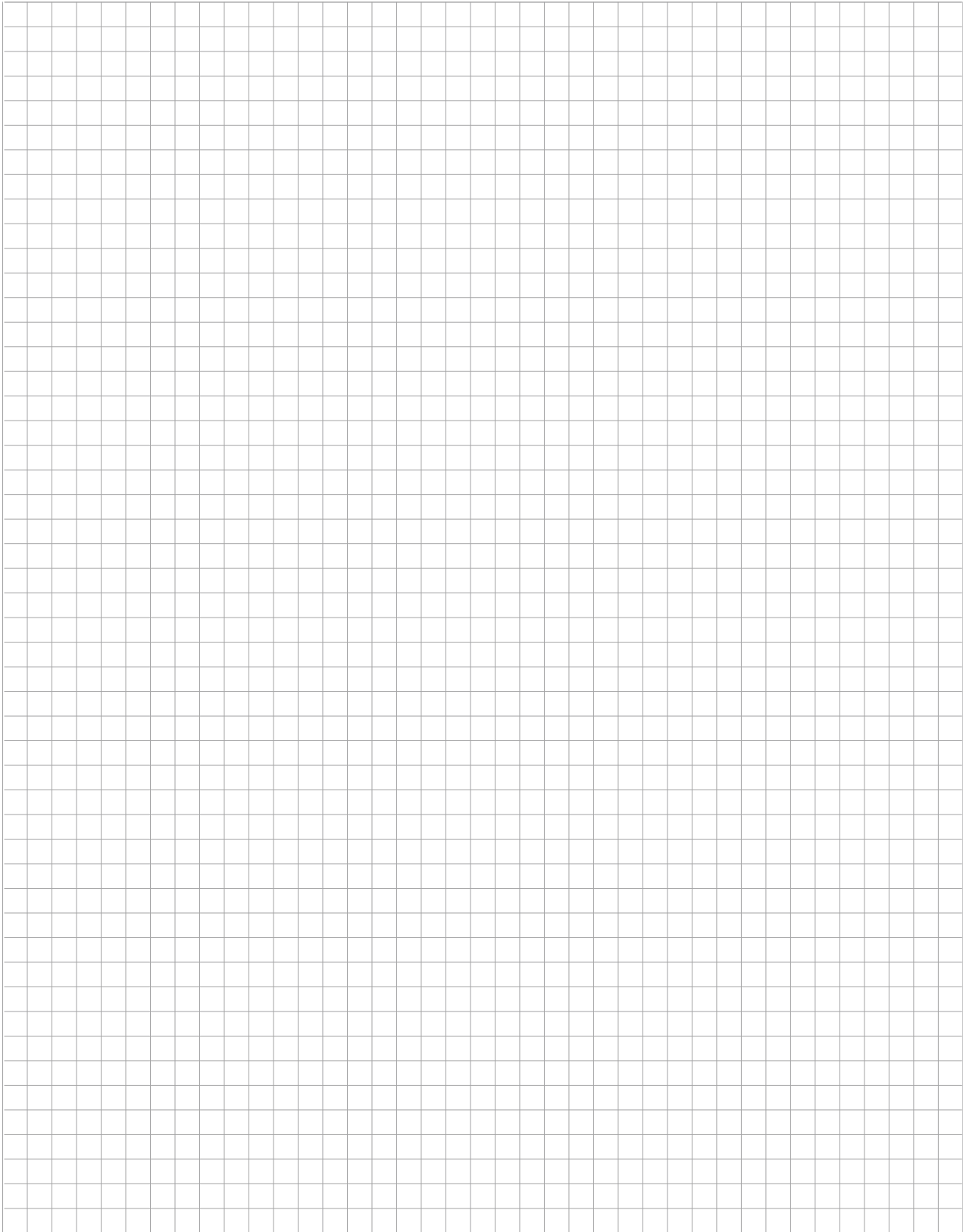



Type NO.	ID NO.	Page NO.	Type NO	ID NO.	Page NO.
GBS20-PI	A2089001	A05	GXEI-DI8DO8	A2060032	B07
GBS20-EI	A2089002	A06	GXEI-DIO16	A2060064	B07
GBS20-EC	A2089006	A07	GXEI-DO16	A2060059	B07
GBS20-EN	A2089004	A08	GXEI-DO8	A2060052	B07
GBS20-DP	A2089003	A09	GXEI-DO8-0100	A2060055	B07
GBS20-DN	A2089007	A10	GXEI-DI16-4000	A2060161	B07
GBS20-CO	A2089005	A11	GXEI-DI8DO8-4000	A2060162	B07
GBS20-4DI-P	A2080002	A12	GXEI-DI8DO8-0100	A2060163	B07
GBS20-8DI-P	A2080003	A12	GXEC-DI16	A2060045	B09
GBS20-16DI-P	A2080004	A12	GXEC-DI16-1000	A2060031	B09
GBS20-8DI-N	A2080012	A13	GXEC-DI8	A2060037	B09
GBS20-16DI-N	A2080013	A13	GXEC-DI8-1000	A2060041	B09
GBS20-8DI-A	A2080011	A14	GXEC-DI8DO8	A2060034	B09
GBS20-8DI8DO-P	A2081014	A15	GXEC-DIO16	A2060063	B09
GBS20-4DO-P	A2081002	A16	GXEC-DO16	A2060058	B09
GBS20-8DO-P	A2081003	A16	GXEC-DO8	A2060051	B09
GBS20-16DO-P	A2081004	A16	GXEC-DO8-0100	A2060054	B09
GBS20-8DO-N	A2081015	A17	GXEN-DI16	A2060047	B11
GBS20-16DO-N	A2081016	A17	GXEN-DI16-1000	A2060030	B11
GBS20-4DO-PH	A2081006	A18	GXEN-DI8	A2060039	B11
GBS20-8DO-P/HF	A2081010	A18	GXEN-DI8-1000	A2060043	B11
GBS20-4DO-R	A2081008	A19	GXEN-DI8DO8	A2060061	B11
GBS20-4AI-I	A2082002	A20	GXEN-DIO16	A2060065	B11
GBS20-4AI-I/iso	A2082004	A20	GXEN-DO16	A2060060	B11
GBS20-4AI-U	A2082007	A21	GXEN-DO8	A2060053	B11
GBS20-4AI-U/iso	A2082009	A21	GXEN-DO8-0100	A2060056	B11
GBS20-4AI-U (-24/0...24V)	A2082012	A22	GXDP-DI16	A2060001	B13
GBS20-2/4AI-PT	A2082014	A23	GXDP-DI16-1000	A2060048	B13
GBS20-4AI-TC/iso	A2082018	A23	GXDP-DI8	A2060036	B13
GBS20-4AO-I(0/4-20mA)	A2083002	A24	GXDP-DI8-1000	A2060040	B13
GBS20-4AO-U	A2083004	A25	GXDP-DI8DO8	A2060002	B13
GBS20-1CNT-24VDC	A2084001	A27	GXDP-DIO16	A2060062	B13
GBS20-1CNT-5VDC	A2084002	A26	GXDP-DO16	A2060004	B13
GBS20-1SSI	A2084003	A28	GXDP-DO8	A2060003	B13
GBS20-1RS232	A2084004	A29	GXDP-DO8-0100	A2060006	B13
GBS20-EMR-5A	A2084006	A30	GXDP-DO16-0100	A2060096	B13
GBS20-PF	A2088001	A32	GXDN-DI16	A2060021	B15
GBS20-BR	A2088007	A31	GXDN-DI8	A2060035	B15
HREP20-DP	A2080111	A33	GXDN-DI8DO8	A2060011	B15
HREP20-DP/4W	A2080112	A33	GXDN-DO16	A2060019	B15
HREP20-DP/6W	A2080113	A33	GXDN-DO8	A2060050	B15
HD9T	A2080101	A33	GXDN-DIO16	A2060100	B15
HD9T-P	A2080102	A33	HC9T-C	A2080121	A34
HD9T-E	A2080103	A33	GXC-PI	A2060200	C05
HD9T-EP	A2080104	A33	GXC-EI	A2060201	C06
HD9T-PM12	A2080163	A34	GXC-EN	A2060202	C07
HD9T-CR	A2080108	A34	GXC-EC	A2060203	C08
HD9T-BFOC	A2080109	A34	GXC-DP	A2060204	C09
HNETL-DP/TCP	A2080110	A34	GXC-DN	A2060205	C10
HC9T	A2080120	A34	GXC-DI8	A2060210	C11
GXPI-DI8	A2060020	B05	GXC-DO8	A2060211	C12
GXPI-DI8-1000	A2060044	B05	GXC-DIO8	A2060212	C13
GXPI-DI16	A2060016	B05	GXC-DI8-N	A2060214	C11
GXPI-DI16-1000	A2060030	B05	GXC-DO8-H	A2060215	C12
GXPI-DO8	A2060017	B05	GXC-DI8-M8	A2060216	C11
GXPI-DO8-0100	A2060057	B05	GXC-DO8-M8	A2060217	C12
GXPI-DI8DO8	A2060022	B05	GXC-DI8-M8-N	A2060218	C11
GXPI-DIO16	A2060025	B05	GXC-DO8-M8-H	A2060219	C12
GXPI-DO16	A2060023	B05	GXC-AI4-I	A2060220	C14
GXEI-DI16	A2060046	B07	GXC-AI4-U	A2060221	C14
GXEI-DI16-1000	A2060029	B07	GXC-AI4-I/U	A2060222	C14
GXEI-DI8	A2060038	B07	GXC-AI4-RTD	A2060223	C15
GXEI-DI8-1000	A2060042	B07	GXC-AI4-TC	A2060224	C15



~ M E M O ~

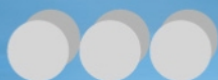

**B.C.E. S.r.l.** - Via Regina Pacis, 54/c - I 41049 Sassuolo (MO), Italy

Tel: (+39) 0536 811616 Fax: (+39) 0536 811500 E-mail: [bce@bce.it](mailto:bce@bce.it) Web: [www.bce.it](http://www.bce.it)

